



M86 Web Filter

USER GUIDE

Models: HL, SL, MSA / Software Version: 4.2.00
Document Version: 10.10.11

M86 WEB FILTER USER GUIDE (HL, SL, MSA)

© 2011 M86 Security
All rights reserved.

Version 1.01, published October 2011 for software release
4.2.00

Printed in the United States of America

This document may not, in whole or in part, be copied, photocopied, reproduced, translated, or reduced to any electronic medium or machine readable form without prior written consent from M86 Security.

Every effort has been made to ensure the accuracy of this document. However, M86 Security makes no warranties with respect to this documentation and disclaims any implied warranties of merchantability and fitness for a particular purpose. M86 Security shall not be liable for any error or for incidental or consequential damages in connection with the furnishing, performance, or use of this manual or the examples herein. Due to future enhancements and modifications of this product, the information described in this documentation is subject to change without notice.

The latest version of this document can be obtained from
<http://www.m86security.com/support/R3000/documentation.asp>

Trademarks

Other product names mentioned in this manual may be trademarks or registered trademarks of their respective companies and are the sole property of their respective manufacturers.

Part# R3000-UG_v1.01-1110

CONTENTS

INTRODUCTORY SECTION	1
Web Filter	1
About this User Guide	1
How to Use this User Guide	3
Conventions	3
Terminology	4
Overview	9
Environment Requirements	10
Workstation Requirements	10
Administrator	10
End User	11
Network Requirements	11
Chapter 1: Filtering Operations	12
Operational Modes	12
Invisible Mode	13
Router Mode	15
Firewall Mode	16
Group Types	18
Global Group	18
IP Groups	19
Filtering Profile Types	20
Static Filtering Profiles	22
Master IP Group Filtering Profile	22
IP Sub-Group Filtering Profile	22
Individual IP Member Filtering Profile	22
Active Filtering Profiles	23
Global Filtering Profile	23
Override Account Profile	23
Time Profile	23
Lock Profile	23
Filtering Profile Components	24
Library Categories	25

M86 Supplied Categories	25
Custom Categories	25
Service Ports	26
Rules	26
Minimum Filtering Level	26
Filter Settings	27
Filtering Rules	28
Filtering Levels Applied	28
Chapter 2: Logging and Blocking	31
Web Access Logging	31
Instant Messaging, Peer-to-Peer Blocking	31
How IM and P2P Blocking Works	31
IM Blocking.....	31
P2P Blocking.....	32
Setting up IM and P2P	33
Using IM and P2P	33
Block IM, P2P for All Users	34
Block IM for All Users	34
Block P2P for All Users.....	34
Block Specified Entities from Using IM, P2P	35
Block IM for a Specific Entity	35
Block P2P for a Specific Entity	35
Chapter 3: Synchronizing Multiple Units	36
Web Filter Synchronization	36
Synchronization Setup	38
Setting up a Source Server	38
Setting up a Target Server	38
Types of Synchronization Processes	39
Filtering Profile Synchronization Process	39
Library Synchronization Process	40
Delays in Synchronization	41
Synchronized, Non-Synchronized Items	42
Synchronize All Items	43
Synchronized Items (All)	43
Functionally Synchronized Items	43
Non-synchronized Items	44
Synchronize Only Library Items	45
Synchronized Items (Library Only).....	45
Functionally Synchronized Items	45

Non-synchronized Items	45
Server Maintenance Procedures	47
Source Server Failure Scenarios	47
Establish Backup Procedures	47
Use a Backup File to Set up a Source Server	48
Set up a Target Server as a Source Server	48
Set up a Replacement Target Server	49
Set up a New Source Server from Scratch	49
Set up a Target Server as a Source Server	49
Chapter 4: Getting Started	50
Initial Setup	50
Access the Administrator Console	50
Log On	50
Last Library Update message	52
Navigation Tips	54
Access Main Sections	54
Help Features	56
Access Help Topics	56
Tooltips	57
Screen and Window Navigation	59
Topic Links.....	59
Select Sub-topics.....	60
Navigate a Tree List.....	61
Tree List Topics and Sub-topics	62
Navigate a Window with Tabs	63
Console Tips and Shortcuts	64
Navigation Path	64
Refresh the Console	64
Select Multiple Items.....	65
Copy and Paste Text	65
Calculate IP Ranges without Overlaps	66
Re-size the User Interface	67
Log Off	68
Technical Support / Product Warranties	68
GLOBAL ADMINISTRATOR SECTION	69
Introduction	69
Chapter 1: System screen	70

Control	72
Filter window	72
Local Filtering.....	73
Disable Local Filtering Options.....	73
Enable Local Filtering Options.....	74
HTTP Filtering.....	74
Enable HTTP Packet Splitting Detection.....	74
Disable HTTP Packet Splitting Detection.....	74
HTTPS Filtering.....	75
Service Control.....	76
Enable Pattern Blocking.....	76
Disable Pattern Blocking.....	77
Target(s) Filtering.....	77
Disable Filtering on Target Servers.....	77
Enable Filtering on Target Servers.....	77
Block Page Authentication window	78
Enter, Edit Block Page Options	79
Block page	80
Options page.....	82
Option 2.....	83
Option 3.....	84
ShutDown window	85
Shut Down the Server.....	85
Reboot window	86
Reboot the Server.....	86
Network	88
LAN Settings window	88
Specify LAN Settings	89
NTP Servers window	90
Specify Network Time Protocol Servers	91
Add an NTP Server.....	91
Remove an NTP Server.....	91
Regional Setting window	92
Specify the Time Zone, Language Set.....	92
Block Page Route Table window	93
Add a Router	94
Remove a Router.....	94
Administrator	95
Administrator window	95
View Administrator Accounts	96
Add an Administrator Account.....	96

Edit an Administrator Account	97
Delete an Administrator Account.....	97
Secure Logon	98
Logon Settings window	98
Enable, Disable Password Expiration	99
Enable, Disable Account Lockout	100
Logon Management	102
View User Account Status, Unlock Username	103
View Account Status.....	103
Unlock a Username	104
View Locked IP Address, Unlock IP Address.....	104
View Locked IPs	104
Unlock an IP Address	104
View Admin, Sub Admin User Interface Access	105
Diagnostics	106
System Command window	106
Perform a Diagnostic Test, View Data	107
Command Selections.....	108
Ping.....	108
Trace Route	108
Process list	108
TOP CPU processes	109
NIC configuration.....	109
Active connections.....	109
Routing table.....	109
Current memory usage.....	110
CPU usage	110
System performance.....	110
Recent logins	110
System uptime	111
df(disk usage)	111
dmesg(print kernel ring buffer).....	111
View Log File window	112
View Log Results	112
Troubleshooting Mode window	114
Use the Troubleshooting Mode	115
Active Profile Lookup window	116
Verify Whether a Profile is Active	117
Admin Audit Trail window	120
Admin Audit Trail.....	120
Specify FTP Criteria.....	121

- FTP the Log on Demand 121
- View 122
- View the Log of Administrator Changes 122
- Alert 123
- Alert Settings window 123
- Enable the Alert Feature 125
- Modify Alert Settings 125
- Disable the Alert Feature 125
- SMTP Server Settings window 126
- Enter, Edit SMTP Server Settings 126
- Verify SMTP Settings 127
- Software Update 128
- Local Software Update window 128
- Read Information about a Software Update 129
- Select and Apply a Software Update 130
- General Software Installation Procedures 130
- Enable/Disable Software Update Type Downloads 132
- First Time LA/Beta Software Install Procedures 133
- Undo an Applied Software Update 134
- Software Update Log window 135
- View Log Contents 135
- Download Log, View, Print Contents 136
- Download the Log 136
- View the Contents of the Log 137
- Save, Print the Log File Contents 139
- Synchronization 140
- Setup window 141
- Using Only One Web Filter on the Network 141
- Using More than One Web Filter on the Network 142
- Set up a Web Filter to be a Source Server 142
- Sync All Target Servers with the Same Settings 145
- Set up a Web Filter to be a Target Server 145
- Status window 147
- View the Sync Status of Targets from the Source 148
- View Items in the Queue 148
- View Items Previously Synced to the Server 149
- Place Items in Queue for Syncing 150
- View the Sync Status of the Target Server 150
- Mode 152
- Operation Mode window 152
- Set the Operation Mode 153

Specify the Listening Device	153
Specify the Block Page Device	153
Invisible Option: Specify the Block Page Delivery	154
ICAP Option: Specify ICAP Server Settings	155
Mobile Options: Specify the Mobile Client Control	157
Apply Operation Mode Settings	157
Proxy Environment Settings window	158
Use a Local Proxy Server	158
Use Proxy Port 80	159
Enable HTTPS Filtering	159
Authentication	160
Backup/Restore	161
Backup/Restore window	161
Backup Procedures	162
Perform a Backup on Demand	163
Schedule a Backup	164
Configure FTP Server Settings	164
Create a Backup Schedule	165
Remove a Backup Schedule	168
Download a File	169
Perform a Restoration	170
Upload a File to the Server	170
Restore Configurations to the Server	171
Remove a Backup File	171
View Backup and Restoration Details	172
Reset	173
Reset window	173
Reset All Server Settings	173
Radius Authentication Settings	174
Radius Authentication Settings window	174
Enable Radius	175
Specify Radius Authentication Settings	175
Apply Settings	176
Disable Radius	176
SNMP	177
SNMP window	177
Enable SNMP	177
Specify Monitoring Settings	178
Set up Community Token for Public Access	178
Create, Build the Access Control List	178
Maintain the Access Control List	178

- Hardware Failure Detection 179
 - Hardware Failure Detection window 179
 - View the Status of the Hard Drives 179
- X Strikes Blocking 181
 - X Strikes Blocking window 181
 - Configuration..... 182
 - Set up Blocking Criteria 182
 - Reset All Workstations..... 183
 - Lock Page..... 183
 - Overblocking or Underblocking..... 184
 - Email Alert..... 185
 - Set up Email Alert Criteria 186
 - Set up Email Alert Recipients 187
 - Remove Email Alert Recipients 187
 - Logon Accounts 188
 - Set up Users Authorized to Unlock Workstations..... 188
 - Deactivate an Authorized Logon Account..... 189
 - Delete a Logon Account 189
 - Categories..... 190
 - Set up Categories to Receive Strikes or No Strikes ... 190
 - Go to X Strikes Unlock Workstation GUI 191
 - Re-login window 191
 - X Strikes Unlock Workstation 192
 - Unlock a Workstation..... 192
 - Set up an Email Address to Receive Alerts 194
 - Remove an Email Address from the Alert List 194
 - Close the Pop-up Window 194
- Warn Option Setting 195
 - Warn Option Setting window 195
 - Specify Interval for Re-displaying the Warn page 196
- Customization 197
 - Common Customization window 198
 - Enable, Disable Features 199
 - Lock Page Customization window 201
 - Edit Entries, Setting 202
 - Preview Sample Lock Page 203
 - Block Page Customization window 204
 - Add, Edit Entries 205
 - Preview Sample Block Page 206
 - Warn Page Customization window 208
 - Add, Edit Entries 209

Preview Sample Warning Page	210
Profile Control window	212
Edit Entries.....	213
Quota Block Page Customization window	214
Add, Edit Entries	214
Preview Sample Quota Block Page	215
Quota Notice Page Customization window	217
Add, Edit Entries	217
Preview Sample Quota Notice Page.....	218
CMC Management	220
Software Update Management window	220
View Software Update Information.....	220
Apply or Undo a Software Update	222
Status window	223
View Filtering Status Information	223
Quota Setting	225
Quota Setting window	225
Configure Quota Hit Settings	226
Reset Quotas	227
Reset Quotas Now.....	227
Set up a Schedule to Automatically Reset Quotas.....	227
Delete a Quota Reset Time from the Schedule	228
Quota Notice page	228
Quota Block page	230
SSL Certificate	231
SSL Certificate window	231
Generate an SSL Certificate for the Web Filter	232
Chapter 2: Policy screen	233
Global Group	235
Range to Detect window	235
Add a Segment to the Network	236
Range to Detect Setup Wizard	238
Range to Detect Advanced Settings.....	243
Modify a Segment of the Network	244
Remove a Segment from the Network	244
Rules window	245
View Criteria for a Rule	245
Add a Rule	246
Modify a Rule	248
Copy a Rule	248

Remove a Rule	249
Global Group Profile window	249
Category Profile	250
Create, Edit a List of Selected Categories.....	250
Port.....	252
Create, Edit a List of Service Ports.....	253
Default Redirect URL	253
Create, Edit the Redirect URL	254
Filter Options.....	254
Create, Edit the Filter Options	254
Override Account window	258
Add an Override Account	259
Category Profile.....	260
Redirect URL	263
Filter Options	264
Edit an Override Account	266
Change the Password	266
Modify an Override Account	267
Delete an Override Account.....	267
Approved Content Settings window	268
Approved Content feature and VuSafe	268
Approved Content setup and configuration.....	269
Approved Content portal setup	269
Approved Content Settings entries.....	270
Minimum Filtering Level window	271
Minimum Filtering Categories	272
Create, Edit Minimum Filtering Categories.....	273
Port	274
Create, Edit a List of Service Ports.....	274
Minimum Filtering Bypass Options.....	275
Specify Minimum Filtering Bypass Options	276
Refresh All	276
Refresh All Main Branches.....	276
IP	277
Add Group	277
Add a Master IP Group	277
Refresh	278
Refresh IP Groups	278
Chapter 3: Library screen	279
Updates	281

Configuration window	281
Set a Time for Updates to be Retrieved.....	281
Optional: Specify a Proxy Server	282
Select the Log Level.....	282
Manual Update window	283
Specify the Type of On Demand Update	283
Additional Language Support window	285
Select Additional Languages.....	285
Library Update Log window	286
View the Library Update Process.....	286
Download Log, View, Print Contents	287
Download the Log.....	287
View the Contents of the Log.....	287
Save, Print the Log File Contents	290
Emergency Update Log window	291
View the Emergency Software Update Process	291
Download the Software Update Log File	292
Library Lookup	293
Library Lookup window	293
URL Lookup, Removal.....	293
Perform a URL Check.....	293
Remove a URL	294
Submit an Email to the Administrator	295
Search Engine Keyword Lookup, Removal.....	295
Perform a Search Engine Keyword Check	295
Remove a Search Engine Keyword.....	295
Reload the Library	296
Customer Feedback Module	296
Customer Feedback Module window	296
Disable Customer Feedback Module	297
Enable Customer Feedback Module.....	297
Category Weight System	300
Category Weight System window	300
View the Current Selections	301
Method for Weighting Library Categories.....	301
Weighting Library Categories	302
NNTP Newsgroup	303
NNTP Newsgroup window	303
Add a Newsgroup to the Library.....	303
Remove a Newsgroup from the Library	304
Pattern Detection Whitelist	305

- Pattern Detection Whitelist window 305
 - Create, Maintain a Whitelist of IP Addresses 306
- Category Groups 307
 - Library Details window 308
 - View Library Details 308
- URLs window 309
 - View a List of URLs in the Library Category 310
 - Add or Remove URLs, Reload the Library 311
 - Add a URL to the Library Category..... 311
 - Add a Wildcard URL to the Library Category..... 312
 - Remove a URL from the Library Category 313
 - Reload the Library 313
- URL Keywords window 314
 - View a List of URL Keywords 315
 - Add or Remove URL Keywords 315
 - Add a URL Keyword to the Library Category..... 315
 - Remove a URL Keyword from the Library 315
 - Upload a List of URL Keywords to the Library 316
 - Upload a List of URL Keyword Additions..... 316
 - Upload a List of URL Keyword Deletions..... 317
 - Reload the Library..... 317
- Search Engine Keywords window 318
 - View a List of Search Engine Keywords 319
 - Add or Remove Search Engine Keywords..... 319
 - Add a Search Engine Keyword to the Library..... 319
 - Remove a Search Engine Keyword from the Library.. 320
 - Upload a List of Search Engine Keywords..... 320
 - Upload a List of Search Engine Keyword Additions ... 320
 - Upload a List of Search Engine Keyword Deletions ... 321
 - Reload the Library..... 321
- Chapter 4: Reporting screen 322**
 - Report Configuration 323
 - Report Configuration window 323
 - Specify the Reporting Device..... 323
 - M86 Security Reporter or Enterprise Reporter 324
 - Edit SR, ER Server Information 324
 - Execute Log Transfer Now 325
 - View Transfer Activity to the SR, ER 325
 - Other Device 325
 - Enter or Edit Server Information 326

View Transfer Activity to the Reporting Device.....	327
Real Time Probe	328
Real Time Probe window	328
Configuration.....	328
Enable Real Time Probes.....	328
Set up Real Time Probes.....	329
Exclude an IP Address from Real Time Probing	329
Remove IPs from the White List	329
Report Recipients	330
Specify Email File Criteria.....	330
Set up Email Addresses to Receive Reports.....	330
Remove Email Addresses	331
Logon Accounts	331
Set up Users Authorized to Create Probes.....	331
Deactivate an Authorized Logon Account.....	332
Delete a Logon Account	332
Go to Real Time Probe Reports GUI	333
Re-login window	333
Real Time Probe Reports	334
Create a Real Time Probe	335
View Real Time Probe Details	338
Shadow Log Format	342
Shadow Log Format window	342
Specify the Shadow Log Format	342
Auto-detect option.....	343
Post 2.0.10 log format option.....	343
Post 2.0 log format option.....	344
Post 1.9 log format option.....	344
Pre 1.9 log format option	344
Apply Setting	344
GROUP ADMINISTRATOR SECTION	345
Introduction	345
Chapter 1: Policy screen	346
IP	347
Refresh	347
Refresh the Master IP Group, Member	347
Master IP Group	348
Group Details window	348

- Change the Group Administrator Password..... 348
- Members window 349
 - Add the IP Address of the Member 350
 - Remove a Member from the Group 350
- Override Account window 351
 - Add an Override Account 352
 - Category Profile 353
 - Redirect URL 356
 - Filter Options 357
 - Edit an Override Account 359
 - Change the Password 359
 - Modify an Override Account 359
 - Delete an Override Account 360
- Group Profile window 360
 - Category Profile 360
 - Create, Edit a List of Selected Categories..... 361
 - Redirect URL 364
 - Create, Edit the Redirect URL 364
 - Filter Options 365
 - Create, Edit the Filter Options 365
- Exception URL window 368
 - Valid URL entries 369
 - Add URLs to Block URL or ByPass URL frame 370
 - Status column messages and icons 371
 - Remove URLs from Block URL or ByPass URL frame 373
 - Apply Settings 374
- Time Profile window 374
 - Add a Time Profile 375
 - Category Profile 380
 - Redirect URL 381
 - Filter Options 382
 - Exception URL..... 383
 - Approved Content..... 384
 - Modify a Time Profile 385
 - Delete a Time Profile..... 385
- Approved Content Settings window 386
 - Approved Content setup and configuration 386
 - Approved Content portal setup 387
 - Approved Content Settings entries 387
- Upload/Download IP Profile window 389
 - Upload IP Profiles 389

Download Profile	391
Add Sub Group	392
Add an IP Sub Group	392
Add Individual IP	393
Add an Individual IP Member	393
Delete Group	394
Delete a Master IP Group Profile	394
Paste Sub Group	394
Paste a Copied IP Sub Group	394
Sub Group	395
Sub Group (IP Group) window	395
View IP Sub-Group Details	395
Add IP Sub-Group Details	396
Members window	397
Modify Sub-Group Members	398
Sub Group Profile window	398
Exception URL window	399
Time Profile window	399
Approved Content Settings window	400
Delete Sub Group	401
Delete an IP Sub-Group	401
Copy Sub Group	401
Copy an IP Sub-Group	401
Individual IP	402
Member window	402
Enter the IP Address of the Member	403
Individual IP Profile window	403
Exception URL window	403
Time Profile window	403
Approved Content Settings window	404
Delete Individual IP	404
Delete an Individual IP Member	404
Chapter 2: Library screen	405
Library Lookup	406
Library Lookup window	406
Look up a URL	407
Look up a Search Engine Keyword	408
Custom Categories	408
Add Category	409
Add a Custom Library Category	409

- Refresh 410
 - Refresh the Library..... 410
- Custom library category 411
 - Library Details window 411
 - View, Edit Library Details 412
 - URLs window 413
 - View a List of URLs in the Library Category 414
 - Add or Remove URLs or Wildcard URLs 415
 - Add a URL to the Library Category..... 415
 - Add a Wildcard URL to the Library Category..... 416
 - Remove a URL from the Library Category 417
 - Upload a Master List to the Library 417
 - Upload a Master List of URLs..... 417
 - Upload a Master List of Wildcard URLs..... 419
 - Reload the Library..... 421
 - URL Keywords window 421
 - View a List of URL Keywords..... 422
 - Add or Remove URL Keywords 422
 - Add a URL Keyword to the Library Category..... 422
 - Remove a URL Keyword from the Library 422
 - Upload a List of URL Keywords to the Library 423
 - Reload the Library..... 423
 - Search Engine Keywords window 424
 - View a List of Search Engine Keywords 425
 - Add or Remove Search Engine Keywords..... 425
 - Add a Search Engine Keyword to the Library..... 425
 - Remove a Search Engine Keyword..... 425
 - Upload a Master List of Search Engine Keywords 426
 - Reload the Library..... 426
 - Delete Category 426
 - Delete a Custom Category..... 426

APPENDICES SECTION 427

Appendix A 427

- Filtering Profile Format and Rules 427
- Rule Criteria 428

Appendix B 431

- Create a Custom Block Page 431
- Part I: Modify the Web Filter 431

1. Enable block page redirection	431
Set up for each sub-group	431
2. Exclude filtering <server for block page> IP.....	432
Part II: Customize the Block Page	432
1. Set up a Web server	432
2. Create a customized block page.....	432
Show M86's information in the block page (optional) .	433
Implement the "further option" (optional)	433
Customized block page examples	434
Part III: Restart the Web Filter	434
Reference	435
HTML	435
CGI written in Perl	437
Embed data in query string.....	437
Use Java Script to post form data.....	438
CGI written in C	440
Appendix C	446
Override Pop-up Blockers	446
Yahoo! Toolbar Pop-up Blocker	447
If Pop-up Blocking is Enabled	447
Add Override Account to the White List	447
Google Toolbar Pop-up Blocker	449
If Pop-up Blocking is Enabled	449
Add Override Account to the White List	449
AdwareSafe Pop-up Blocker	450
If Pop-up Blocking is Enabled	450
Temporarily Disable Pop-up Blocking	450
Mozilla Firefox Pop-up Blocker	451
Add Override Account to the White List	451
Windows XP SP2 Pop-up Blocker	453
Set up Pop-up Blocking	453
Use the Internet Options dialog box.....	453
Use the IE Toolbar	454
Temporarily Disable Pop-up Blocking	454
Add Override Account to the White List	455
Use the IE Toolbar	455
Use the Information Bar	456
Set up the Information Bar.....	456
Access your Override Account	456

Appendix D	458
Mobile Client	458
Environment Requirements	459
Workstation Requirements.....	459
Network Requirement	460
Remote Filtering Components	460
Work Flow Overview	460
Mobile Client Installed on a Mobile PC	460
Network Operations Overview	461
Mobile Client on the Network	461
Mobile Client.....	461
Enterprise Reporter	461
Mobile Server Section	462
Initial Setup	462
Configure the Web Filter to use the Mobile Mode	463
Add MAC Addresses to the Master IP Group	464
Select MAC Addresses for a Sub Group.....	465
View Sub Group MAC Addresses	466
Add a MAC Address to an Individual Member	467
Upload MAC Address File for IP Group	468
Troubleshoot MAC Addresses	469
Mobile Client Section	470
Download and Install the Deployment Kit	471
Access the Mobile Client Deployment Tool window	474
Configure a New Package Set	475
Specify Package criteria	476
Configure Network Settings.....	477
Optional: Specify URL for Mobile Client Updates.....	480
Optional: Set up Application Options.....	481
Save configuration settings, download files.....	485
Edit a Package Configuration	489
Edit default configuration settings.....	490
View Package Configuration contents	491
MCU file preparations	492
Step 1: Install MCU on end user workstations.....	492
Step 2: Choose a deployment host for updates.....	493
Step 3: Post the latest files for MCU.....	495
MC Deployment to Windows Computers	497
Deployment to a group	497
Installation on a single computer	500
MC Deployment to Macintosh OS X Computers.....	500

Mobile Client Removal from Computers	501
Uninstallation from a Windows group	501
Uninstallation from an individual computer	501
Appendix E	504
Configure the Web Filter for Reporting	504
Entries in the Web Filter Administrator console	504
Entries in the SR, ER Administrator console	506
Appendix F	507
RAID and Hardware Maintenance	507
Part 1: Hardware Components	507
Part 2: Server Interface	507
LED indicators in SL and HL units	507
Front control panels on SL and HL units	509
Rear panels on HL units	511
Part 3: Troubleshooting	512
Hard drive failure.....	512
Step 1: Review the notification email.....	512
Step 2: Verify the failed drive in the Admin console ...	513
Step 3: Replace the failed hard drive.....	514
Step 4: Rebuild the hard drive	515
Step 5: Contact Technical Support.....	515
Power supply failure.....	515
Step 1: Identify the failed power supply	515
Step 2: Unplug the power cord	515
Step 3: Replace the failed power supply	516
Step 4: Contact Technical Support.....	516
Fan failure	517
Identify a fan failure	517
Appendix G	518
Glossary	518
INDEX	525

INTRODUCTORY SECTION

Web Filter

M86 Security's Web Filter tracks each user's online activity, and can be configured to block specific Web sites, service ports, and pattern and file types, and lock out an end user from Internet access, thereby protecting your organization against lost productivity, network bandwidth issues, and possible legal problems that can result from the misuse of Internet resources.

The Web Filter provides an extensive library filtering category database, user authentication, implementation of time and quota filtering profiles, and tools for tailoring a user's filtering profile to comply with your organization's Internet usage policy, based on the end user's Internet usage habits.

About this User Guide

The Web Filter User Guide primarily addresses the network administrator designated to configure and manage the Web Filter server on the network. This administrator is referred to as the "global administrator" throughout this user guide. In part, this user guide also addresses administrators who manage user groups on the network. These administrators are referred to as "group administrators" throughout this user guide. Additional information is provided for administrators of networks that use the Web Filter with M86's Security Reporter (SR) or M86's Enterprise Reporter (ER) to execute both filtering and reporting functions.

See the M86 Web Filter Authentication User Guide at <http://www.m86security.com/support/R3000/documentation.asp> for information on authentication.

This user guide is organized into the following sections:

- **Introductory Section** - This section is comprised of an overview on filtering, Web access logging, instant messaging and peer-to-peer blocking, and synchronizing multiple Web Filter units. This section also provides information on how to use this user guide to help you configure the Web Filter, and provides information on how to contact M86 Security technical support.
- **Global Administrator Section** - This section includes information for the global administrator—who has all rights and permissions on the Web Filter—to create group administrator accounts, and to configure the Web Filter for filtering the entire network.
- **Group Administrator Section** - This section includes information for administrators authorized by the global administrator to manage profiles of designated groups and their associated users on the Web Filter. Group administrators also have rights to access certain library category functions.
- **Appendices** - Appendix A includes formats and rules used in the filtering profile file. Appendix B includes information on creating a customized block page. Appendix C provides tips on how to override pop-up windows with pop-up blocker software installed. Appendix D explains how to install, configure, and use the Mobile Client. Appendix E includes information on configuring the Web Filter to work with M86's Security Reporter (SR) or M86's Enterprise Reporter (ER) application. Appendix F includes information about RAID and hardware maintenance and troubleshooting. Appendix G features a glossary of technical terminology used in this user guide.
- **Index** - This section includes an index of subjects and the first page numbers where they appear in this user guide.

How to Use this User Guide

Conventions

The following icons are used throughout this user guide:



NOTE: The “note” icon is followed by italicized text providing additional information about the current subject.



TIP: The “tip” icon is followed by italicized text giving you hints on how to execute a task more efficiently.



WARNING: The “warning” icon is followed by italicized text cautioning you about making entries in the application, executing certain processes or procedures, or the outcome of specified actions.

Terminology

The following terms are used throughout this user guide. Sample images (not to scale) are included for each item.

- **alert box** - a message box that opens in response to an entry you made in a dialog box, window, or screen. This box often contains a button (usually labeled “OK”) for you to click in order to confirm or execute a command.



- **button** - an object in a dialog box, window, or screen that can be clicked with your mouse to execute a command.

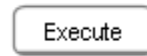

- **checkbox** - a small square in a dialog box, window, or screen used for indicating whether or not you wish to select an option. This object allows you to toggle between two choices. By clicking in this box, a check mark or an “X” is placed, indicating that you selected the option. When this box is not checked, the option is not selected.

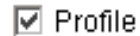

- **dialog box** - a box that opens in response to a command made in a window or screen, and requires your input. You must choose an option by clicking a button (such as “Yes” or “No”, or “Next” or “Cancel”) to execute your command. As dictated by this box, you also might need to make one or more entries or selections prior to clicking a button.

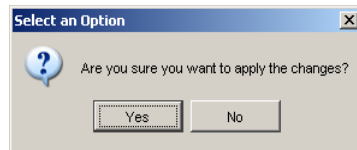

- **field** - an area in a dialog box, window, or screen that either accommodates your data entry, or displays pertinent information. A text box is a type of field.

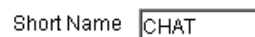

- frame** - a boxed-in area in a dialog box, window, or screen that includes a group of objects such as fields, text boxes, list boxes, buttons, radio buttons, check-boxes, and/or tables. Objects within a frame belong to a specific function or group. A frame often is labeled to indicate its function or purpose.

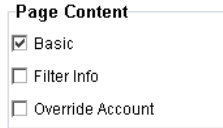

- grid** - an area in a frame that displays rows and columns of data, as a result of various processes. This data can be reorganized in the Administrator console, by changing the order of the columns.

Date	Filename	Content	Comment
Jul 22, 2003	lib1.tar.gz	LIBRARY_ONLY	backup old library
Jul 23, 2003	config3.tar.gz	CONFIG_ONLY	backup old configurations
Jul 22, 2003	config1.tar.gz	CONFIG_ONLY	testing
Jul 22, 2003	both.tar.gz	CONFIG_AND_LIBRARY	backup library and configs

- list box** - an area in a dialog box, window, or screen that accommodates and/or displays entries of items that can be added or removed.



- navigation panel** - the panel that displays at the left of a screen. This panel can contain links that can be clicked to open windows or dialog boxes at the right of the screen. One or more tree lists also can display in this panel. When an item in the tree list is clicked, the tree list opens to reveal items that can be selected.



- **pop-up box or pop-up window** - a box or window that opens after you click a button in a dialog box, window, or screen. This box or window may display information, or may require you to make one or more entries.

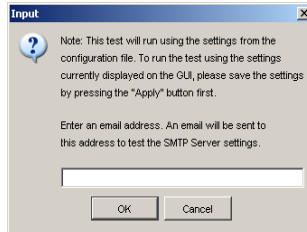

Unlike a dialog box, you do not need to choose between options.

- **pull-down menu** - a field in a dialog box, window, or screen that contains a down-arrow to the right.



When you click the arrow, a menu of items displays from which you make a selection.

- **radio button** - a small, circular object in a dialog box, window, or screen

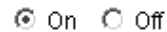

used for selecting an option. This object allows you to toggle between two choices. By clicking a radio button, a dot is placed in the circle, indicating that you selected the option. When the circle is empty, the option is not selected.

- **screen** - a main object of an application that displays across your monitor. A screen can contain panels, windows, frames, fields, tables, text boxes, list boxes, icons, buttons, and radio buttons.



- sub-topic** - a subset of a main topic that displays as a menu item for the topic. The menu of sub-topics opens when a pertinent topic link in the left panel—the navigation panel—of a screen is clicked. If a sub-topic is selected, the window for that sub-topic displays in the right panel of the screen, or a pop-up window or an alert box opens, as appropriate.

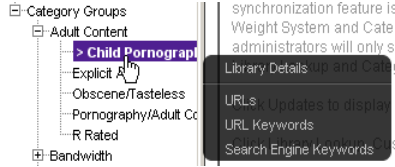

- text box** - an area in a dialog box, window, or screen that accommodates your data entry. A text box is a type of field. (See “field”.)

- topic** - a topic displays as a link in the left panel—the navigation panel—of a screen. By clicking the link for a topic, the window for that topic displays in the right panel of the screen, or a menu of sub-topics opens.



- tree** - a tree displays in the navigation panel of a screen, and is comprised of a hierarchical list of items. An entity associated with a branch of the tree is preceded by a plus (+) sign when the branch is collapsed. By double-clicking the item, a minus (-) sign replaces the plus sign, and any entity within that branch of the tree displays. An item in the tree is selected by clicking it.
- window** - a window displays on a screen, and can contain frames, fields, text boxes, list boxes, buttons, checkboxes, and radio buttons. A window for a topic or sub-topic displays in the right panel of the screen. Other types of windows include pop-up windows, login windows, or ones from the system such as the Save As or Choose file windows.

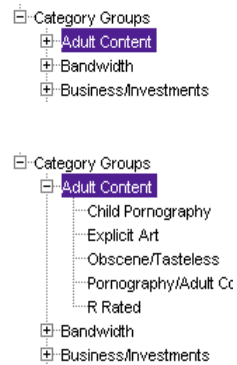

Overview

The Web Filter's Administrator console is used by the global administrator—and group administrator, as required—to configure the Web Filter server to perform the following basic functions:

- filter URLs (Web addresses) on the Internet
- log traffic on the Internet

and, if applicable for your organization:

- block instant messaging, peer-to-peer services, and patterns
- authenticate users via the existing authentication system on the network



NOTE: See the *M86 Web Filter Authentication User Guide* at <http://www.m86security.com/support/R3000/documentation.asp> for information on setting up and using authentication.

- synchronize multiple Web Filter units so that all servers will be updated with the same user profile and library configurations

To help you become familiar with the Web Filter and how it functions on the network, Chapter 1 of this section of the User Guide provides an overview on filtering. Chapter 2 gives insight into Web site access logging, and instant messaging and peer-to-peer setup procedures. Chapter 3 features information on synchronizing multiple Web Filter units. Chapter 4 includes details on getting started, with log in and log out procedures, and tips on navigating the Administrator console.

Environment Requirements

Workstation Requirements

Administrator

System requirements for the administrator include the following:

- Windows XP, Vista, or 7 operating system running:
 - Internet Explorer (IE) 8.0
 - Firefox 6.0
 - Google Chrome 13.0
 - Safari 5.1
- Macintosh OS X Version 10.6 or 10.7 running:
 - Safari 5.1
 - Firefox 6.0
- JavaScript enabled
- Java Virtual Machine
- Java Plug-in
- Pop-up blocking software, if installed, must be disabled
- Session cookies from the Web Filter must be allowed in order for the Administrator console to function properly



NOTE: *Web Filter administrators must be set up with software installation privileges in order to install Java used for accessing the user interface.*

End User

System requirements for the end user include the following:

- Windows XP, Vista, or 7 operating system running:
 - Internet Explorer (IE) 8.0
 - Firefox 6.0
 - Google Chrome 13.0
 - Safari 5.1
- Macintosh OS X Version 10.6 or 10.7 running:
 - Safari 5.1
 - Firefox 6.0
- JavaScript enabled
- Pop-up blocking software, if installed, must be disabled

Network Requirements

- High speed connection from the Web Filter server to the client workstations
- HTTPS connection to M86's software update server
- Internet connectivity for downloading Java virtual machine, if not already installed

Chapter 1: Filtering Operations

Operational Modes

Based on the setup of your network, the Web Filter can be configured to use one of these operational modes for filtering the network:

- invisible mode
- router mode
- firewall mode

Invisible Mode

If the Web Filter is set in the invisible mode, the unit will filter all connections on the Ethernet between client PCs and the Internet, without stopping each IP packet on the same Ethernet segment. The unit will only intercept a session if an inappropriate request was submitted by a client. In this scenario, the Web Filter returns a message to the client and server to deny the request, and a block page displays to deny the client access to the site or service.

Figure 1:1-1 depicts the invisible mode that removes the Web Filter from any inclusion in the network connection path.

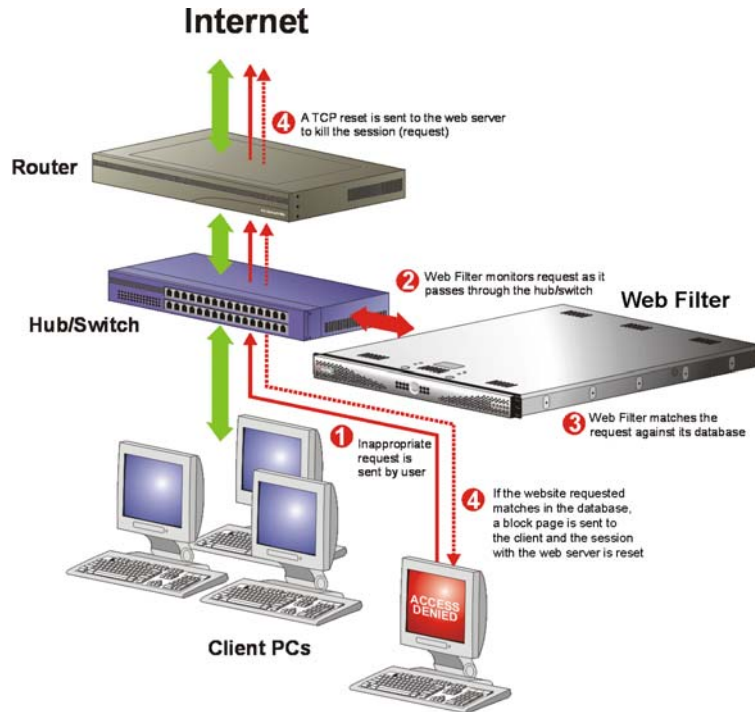

Fig. 1:1-1 Pass-by filtering diagram

When users (Client PCs) make Internet requests, the traffic flows (1) through the network path without interruption. The Web Filter captures the request as the user's request (2) leaves the network. The Web Filter then determines the action (3) to either block or pass the request. If the Web Filter determines to block the user's request, a block message (4) is sent to the user plus a terminate message (4) is sent to the Internet server.

A Web Filter set up in the invisible mode can also work in the router mode. Figure 1:1-2 illustrates an example of a monitor mode setup, with the Web Filter connected to the managed switching hub. In this setup, the Web Filter port is configured with the port monitoring function enabled, so that the Web Filter's port mirrors the port connected to the router.

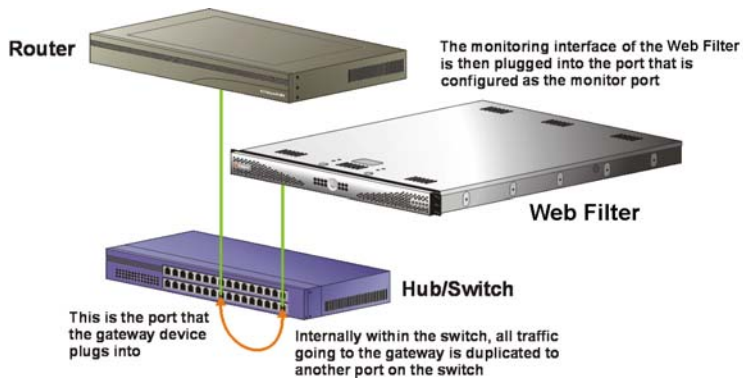

Fig. 1:1-2 Invisible mode diagram, with port monitoring

In the invisible mode, the Web Filter performs as a stand-alone server that can be connected to any network environment.

Router Mode

If the Web Filter is set up in the router mode, the unit will act as an Ethernet router, filtering IP packets as they pass from one card to another. While all original packets from client PCs are allowed to pass, if the Web Filter determines that a request is inappropriate, a block page is returned to the client to replace the actual requested Web page or service.

Since only outgoing packets need to be routed—and not return packets—the Web Filter only appears in the outgoing path of the network.

Figure 1:1-3 illustrates an example of the router mode setup, in which the Web Filter is set up to act as the Internet router.

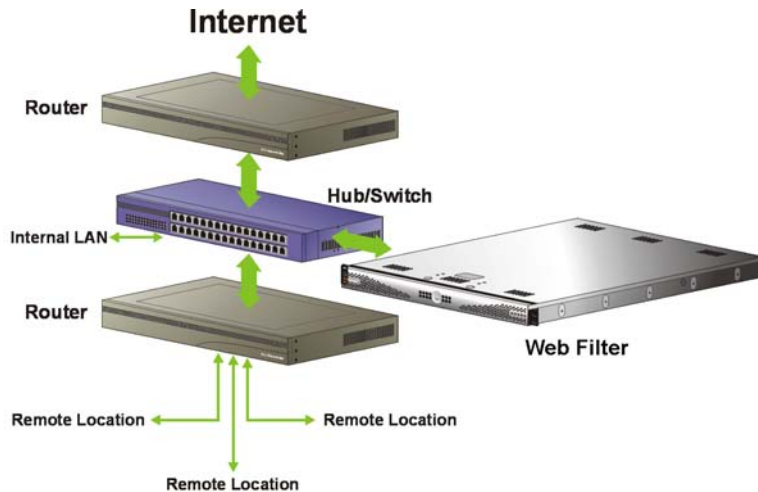

Fig. 1:1-3 Router mode diagram

As previously mentioned, a Web Filter set up in the router mode can also work in the invisible mode. The router mode setup also will work in the firewall mode.

WARNING: M86 recommends contacting one of our solutions engineers if you need assistance with router mode setup procedures.

Firewall Mode

The firewall mode is a modification of the router mode. With the Web Filter set up in this mode, the unit will filter all requests. If the request is appropriate, the original packet will pass unchanged. If the request is inappropriate, the original packet will be blocked from being routed through.

Using the firewall mode, while the outgoing request is delayed slightly—to allow filtering to take place before the packet leaves the gateway router of the network—return traffic remains unaffected.

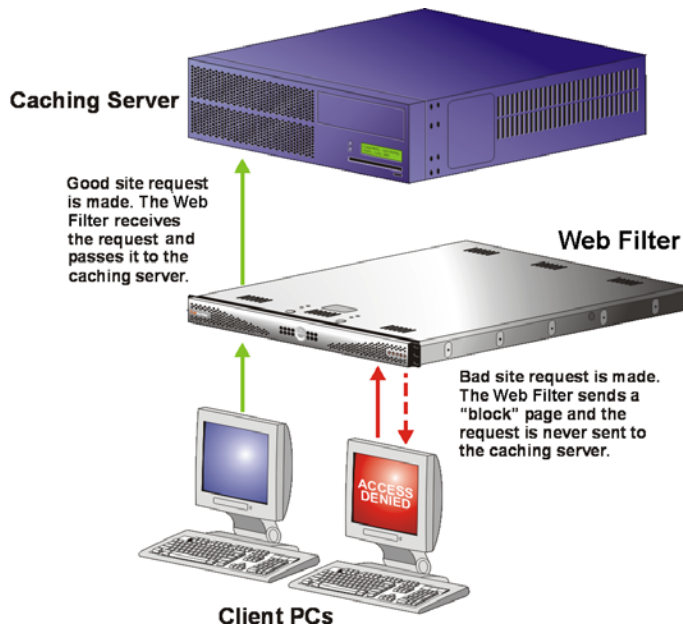



Fig. 1:1-4 Firewall mode diagram, with firewall and cache setup

The firewall mode cannot be used with any other mode (invisible or router).

Figure 1:1-4 illustrates an example of a firewall mode setup in which requests are never sent to the caching server. In this scenario the local caching proxy will not affect the Web Filter—even if the server contains unfiltered, “bad” cached pages—since no request can pass until it is filtered.

Figure 1:1-5 illustrates an example of a firewall mode setup in which requests are always sent to the caching server. In this scenario the Web Filter *will* be affected if the caching proxy server contains unfiltered, “bad” cached pages. M86 recommends that cached content is cleared or expired after installing the Web Filter.

 **WARNING:** Contact a solutions engineer at M86 Security for setup procedures if you wish to use the firewall mode.

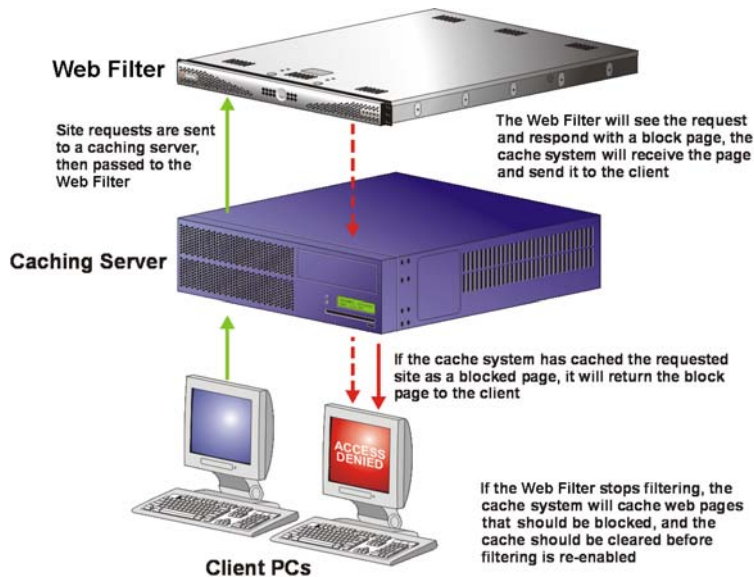

Fig. 1:1-5 Firewall mode diagram, with filtering and cache setup

Group Types

After the operational filtering mode is configured on the Web Filter, the group type(s) that will be used on the Web Filter must be set up so that filtering can take place.

In the Policy section of the Administrator console, group types are structured in a tree format in the navigation panel. The global administrator can access the Global Group and IP groups in the tree. The group administrator can only access the designated IP group to be maintained.



NOTES: *If authentication is enabled, the global administrator can also access the LDAP branch of the tree.*

If multiple Web Filter units are set up on the network and the synchronization feature is used, a Web Filter that is set up to receive profile changes will only display the Global Group type in the tree list. (See Chapter 3: Synchronizing Multiple Units for more information on synchronization.)



Global Group

The first group that must be set up is the global group,

represented in the tree structure by the global icon .

The filtering profile created for the global group represents the default profile to be used by all groups that do not have a filtering profile, and all users who do not belong to a group.

IP Groups

The IP group type is represented in the tree by the IP icon . A master IP group is comprised of sub-group members and/or individual IP members .

The global administrator adds master IP groups, adds and maintains override accounts at the global level, and establishes and maintains the minimum filtering level.

The group administrator of a master IP group adds sub-group and individual IP members, override account, time profiles and exception URLs, and maintains filtering profiles of all members in the master IP group.

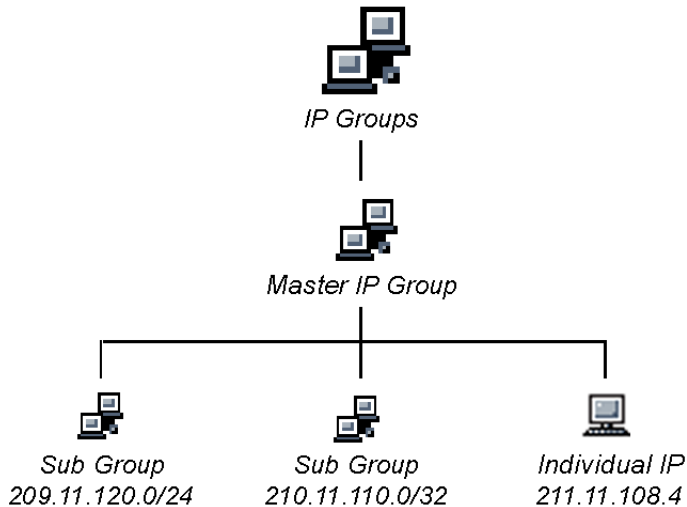

Fig. 1:1-6 IP diagram with a sample master IP group and its members

Filtering Profile Types

A filtering profile is used by all users who are set up to be filtered on the network. This profile consists of rules that dictate whether a user has access to a specified Web site or service on the Internet.

The following types of filtering profiles can be created, based on the setup in the tree menu of the Policy section of the console:

Global Group

- **global filtering profile** - the default filtering profile positioned at the base of the hierarchical tree structure, used by end users who do not belong to a group.

IP group (master group)

- **master group filtering profile** - used by end users who belong to the master group.
- **master time profile** - used by master group users at a specified time.

IP group member

- **sub-group filtering profile** - used by a sub-group member.
- **individual filtering profile** - used by an individual IP group member.
- **time profile** - used by a sub-group/individual IP group member at a specified time.

Other filtering profiles

- **authentication profile** - used by LDAP group members. This type of profile includes the workstation profile.



NOTE: For information about authentication filtering profiles, see the *M86 Web Filter Authentication User Guide*.

- **override account profile** - set up in either the Global Group section or the master IP group section of the console.
- **lock profile** - set up under X Strikes Blocking in the Filter Options section of the profile.
- **Radius profile** - used by end users on a Radius accounting server if the Radius server is connected to the Web Filter and the Radius authentication feature enabled.
- **TAR profile** - used if a Threat Analysis Reporter (TAR) server is connected to the Web Filter and an end user is locked out by TAR when attempting to access blocked content in a library category.

Static Filtering Profiles

Static filtering profiles are based on fixed IP addresses and include profiles for master IP groups and their members.

Master IP Group Filtering Profile

The master IP group filtering profile is created by the global administrator and is maintained by the group administrator. This filtering profile is used by members of the group—including sub-group and individual IP group members—and is customized to allow/deny users access to URLs, or warn users about accessing specified URLs, to redirect users to another URL instead of having a block page display, and to specify usage of appropriate filter options.

IP Sub-Group Filtering Profile

An IP sub-group filtering profile is created by the group administrator. This filtering profile applies to end users in an IP sub-group and is customized for sub-group members.

Individual IP Member Filtering Profile

An individual IP member filtering profile is created by the group administrator. This filtering profile applies to a specified end user in a master IP group.

Active Filtering Profiles

Active filtering profiles include the Global Group Profile, Override Account profile, Time Profile, and Lock profile.



NOTE: For information about authentication filtering profiles, see the *M86 Web Filter Authentication User Guide*.

Global Filtering Profile

The global filtering profile is created by the global administrator. This profile is used as the default filtering profile. The global filtering profile consists of a customized profile that contains a list of library categories to block, open, add to a white list, or assign a warn setting, and service ports that are configured to be blocked. A URL can be specified for use instead of the standard block page when users attempt to access material set up to be blocked. Various filter options can be enabled.

Override Account Profile

If any user needs access to a specified URL that is set up to be blocked, the global administrator or group administrator can create an override account for that user. This account grants the user access to areas set up to be blocked on the Internet.

Time Profile

A time profile is a customized filtering profile set up to be effective at a specified time period for designated users.

Lock Profile

This filtering profile blocks the end user from Internet access for a set period of time, if the end user's profile has the X Strikes Blocking filter option enabled and he/she has received the maximum number of strikes for inappropriate Internet usage.

Filtering Profile Components

Filtering profiles are comprised of the following components:

- **library categories** - used when creating a rule, minimum filtering level, or filtering profile for the global group or any entity
- **service ports** - used when setting up filter segments on the network, creating the global group (default) filtering profile, or establishing the minimum filtering level
- **rules** - specify which library categories should be blocked, left open (a set number of minutes in which that category remains open can be defined), assigned a warn setting, or white listed
- **filter options** - specify which features will be enabled: X Strikes Blocking, Google/Bing/Yahoo!/Youtube/Ask/AOL Safe Search Enforcement, Search Engine Keyword Filter Control, URL Keyword Filter Control
- **minimum filtering level** - takes precedence over filtering profiles of entities who are using a filtering profile other than the global (default) filtering profile
- **filter settings** - used by service ports, filtering profiles, rules, and the minimum filtering level to indicate whether users should be granted or denied access to specified Internet content

Library Categories

A library category contains a list of Web site addresses and keywords for search engines and URLs that have been set up to be blocked or white listed. Library categories are used when creating a rule, the minimum filtering level, or a filtering profile.

M86 Supplied Categories

M86 furnishes a collection of library categories, grouped under the heading “Category Groups” (excluding the “Custom Categories” group). Updates to these categories are provided by M86 on an ongoing basis, and administrators also can add or delete individual URLs within a specified library category.

Custom Categories

Custom library categories can be added by either global or group administrators. As with M86 supplied categories, additions and deletions can be made within a custom category. However, unlike M86 supplied categories, a custom category can be deleted.



NOTE: *M86 cannot provide updates to custom categories. Maintaining the list of URLs and keywords is the responsibility of the global or group administrator.*

Service Ports

Service ports are used when setting up filter segments on the network (the range of IP addresses/netmasks to be detected by the Web Filter), the global (default) filtering profile, and the minimum filtering level.

When setting up the range of IP addresses/netmasks to be detected, service ports can be set up to be open (ignored). When creating the global filtering profile and the minimum filtering level, service ports can be set up to be blocked or filtered.

Examples of service ports that can be set up include File Transfer Protocol (FTP), Hyper Text Transfer Protocol (HTTP), Network News Transfer Protocol (NNTP), Secured HTTP Transmission (HTTPS), and Secure Shell (SSH).

Rules

A rule is comprised of library categories to block, leave open, assign a warn setting, or include in a white list. Access to an open library category can be restricted to a set number of minutes. Each rule that is created by the global administrator is assigned a number. A rule is selected when creating a filtering profile for an entity.

Minimum Filtering Level

The minimum filtering level consists of library categories set up at the global level to be blocked or opened, and service ports set up to be blocked or filtered. If the minimum filtering level is created, it applies to all users in IP groups, and takes precedence over filtering settings made for group and user filtering profiles.

The minimum filtering level does not apply to any user who does not belong to a group, and to groups that do not have a filtering profile established.



NOTE: If the minimum filtering level is not set up, global (default) filtering settings will apply instead.

If an override account is established at the IP group level for a member of a master IP group, filtering settings made for that end user will override the minimum filtering level if the global administrator sets the option to allow the minimum filtering level to be bypassed. An override account established at the global group level will automatically bypass the minimum filtering level.

Filter Settings

Categories and service ports use the following settings to specify how filtering will be executed:

- **block** - if a category or a service port is given a block setting, users will be denied access to the URL set up as “blocked”
- **open** - if a category or the filter segment detected on the network is given an open (pass) setting, users will be allowed access to the URL set up as “opened”



NOTE: Using the quota feature, access to an open category can be restricted to a defined number of minutes.

- **always allowed** - if a category is given an always allowed setting, the category is included in the user’s white list and takes precedence over blocked categories



NOTE: A category that is allowed will override any blocked settings except if the minimum filtering level is set to block that category.

- **warn** - If a category is given a warn setting, a warning page displays for the end user to warn him/her that accessing the intended URL may be against established policies and to proceed at his/her own risk

- **filter** - if a service port is given a filter setting, that port will use filter settings created for library categories (block or open settings) to determine whether users should be denied or allowed access to that port
- **ignore** - if the filter segment detected on the network has a service port set up to be ignored, that service port will be bypassed

Filtering Rules

Filtering Levels Applied

1. The global (default) filtering profile applies to any user who does not belong to a master IP group.
2. If the minimum filtering level is defined, it applies to all master IP groups and members assigned filtering profiles. The minimum filtering level combines with the user's profile to guarantee that categories blocked in the minimum filtering level are blocked in the user's profile.
3. For master IP group members:
 - a. A master IP group filtering profile takes precedence over the global profile.
 - b. A master IP group time profile takes precedence over the master IP group profile.
4. For IP sub-group members:
 - a. An IP sub-group filtering profile takes precedence over the master IP group's time profile.
 - b. An IP sub-group time profile takes precedence over the IP sub-group profile.
5. For individual IP members:
 - a. An individual IP member filtering profile takes precedence over the IP sub-group's time profile.

- b. An individual IP member time profile takes precedence over the individual IP member profile.
6. An authentication (LDAP) profile—this includes a workstation profile—takes precedence over an individual IP member's time profile.



NOTE: A Radius profile is another type of authentication profile and is weighted the same as LDAP authentication profiles in the precedence hierarchy.

7. A Threat Analysis Reporter (TAR) profile is a type of lockout profile. If using the M86 Threat Analysis Reporter with a Web Filter server, the TAR low level lockout profile takes precedence over an authentication profile or a time profile profile, locking out the end user from library categories specified in the lockout profile in the TAR application.
8. An override account profile takes precedence over a TAR lockout profile. This account may override the minimum filtering level—if the override account was set up in the master IP group tree, and the global administrator allows override accounts to bypass the minimum filtering level, or if the override account was set up in the Global Group tree.



NOTE: An override account set up in the master group section of the console takes precedence over an override account set up in the Global Group section of the console.

9. An X Strikes lockout profile takes precedence over all filtering profiles. This profile is set up under Filter Options, by enabling the X Strikes Blocking feature.

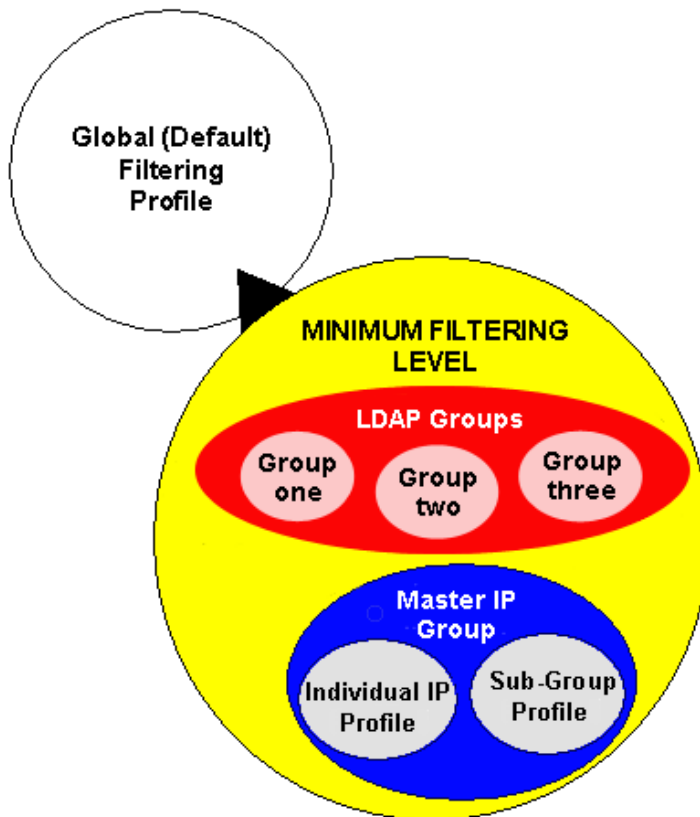

Fig. 1:1-7 Sample filtering hierarchy diagram

Chapter 2: Logging and Blocking

Web Access Logging

One of the primary functions of the Web Filter is to log the activity of users on the Internet. Information captured in the log can be transferred to a reporting appliance, to be viewed on a PC monitor or output to a printer.

M86 recommends using the M86 Security Reporter (SR) or M86 Enterprise Reporter (ER) for generating reports. When the SR or ER server application is connected to the Web Filter server, log files from the Web Filter are transferred to that reporting server application where they are “normalized” and then inserted into a MySQL database. The reporting server’s client application accesses that database to generate queries and reports.



NOTE: See Appendix E: *Configuring the Web Filter for Reporting* for information on configuring the Web Filter and M86 reporting device.

Instant Messaging, Peer-to-Peer Blocking

The Web Filter has options for blocking and/or logging the use of Instant Messaging and Peer-to-Peer services, and makes use of Intelligent Footprint Technology (IFT) for greatly increasing management and control of these popular—yet potentially harmful—applications. This section explains how to set up and use IM and P2P.

How IM and P2P Blocking Works

IM Blocking

Instant Messaging (IM) involves direct connections between workstations either locally or across the Internet. Using this

feature of the Web Filter, groups and/or individual client machines can be set up to block the use of IM services specified in the library category.

When the IM module is loaded on the server, the Web Filter compares packets on the network with IM libraries stored on the Web Filter. If a match is found, the Web Filter checks the user's profile to see whether the user's connection to the IM service should be blocked, and then performs the appropriate action.



WARNING: *The following items are known issues pertaining to the IM module:*

- *IM can only block by destination IP address if network traffic is being tunneled, sent through a Virtual Private Network (VPN), or encrypted.*
- *IM will not be blocked if a client-side VPN is set up to proxy traffic through a remote IP address outside the connection protected by the Web Filter.*
- *Some versions of the AOL client create a network interface that send a network connection through a UDP proxy server, which prevents blocking IM.*

P2P Blocking

Peer-to-Peer (P2P) involves communication between computing devices—desktops, servers, and other smart devices—that are linked directly to each other. Using this feature of the Web Filter, groups and/or individual client machines can be set up to block the use of P2P services specified in the library category.

When the P2P module is loaded on the server, the Web Filter compares packets on the network with the P2P library stored on the Web Filter. If a match is found, the Web Filter checks the user's profile to see whether the user's connection to the P2P service should be blocked, and then performs the appropriate action.

Setting up IM and P2P

IM and P2P are set up in the System and Library sections of the Administrator console.

1. In the System section, activate Pattern Blocking in the Filter window.
2. In the Library section, note the services set up to be blocked, as defined at: http://www.m86security.com/software/8e6/hlp/r3000/files/1system_im_block.html.



NOTE: Please contact an M86 technical support representative or a solutions engineer if access is needed to one or more P2P services blocked by M86's supplied library category for P2P.

3. In the Manual Update to M86 Supplied Categories window (accessible via Library > Updates > Manual Update), IM pattern files can be updated on demand.

Using IM and P2P

To solely log IM and/or P2P user activity, the Pattern Blocking setting needs to be enabled in the Filter window.

To additionally block specified groups and/or users from using components and features of IM and/or P2P, settings need to be made in the Policy section of the Administrator console.

If applying M86's supplied IM and/or P2P library category to an entity's profile, all IM and/or P2P services included in that category will be blocked.



NOTE: If IM and/or P2P was set up to be blocked while a user's IM and/or P2P session was in progress, the user will not be blocked from using that service until he/she logs off the server and back on again.

Block IM, P2P for All Users

Block IM for All Users

To block IM for all users on the network:

- the Pattern Blocking option in the Filter window must be activated
- the global filtering profile must have **both** CHAT and specified individual Instant Messaging library categories (such as IMGEN, IMGCHAT, IMGTalk, ICQAIM, IMMSN, IMMYS, and/or IMYAHOO) set up to be blocked
- the minimum filtering level profile must have **both** CHAT and specified individual Instant Messaging library categories set up to be blocked.

Block P2P for All Users

To block P2P for all users on the network:

- the Pattern Blocking option in the Filter window must be activated
- the global filtering profile must have the PR2PR library category set up to be blocked
- the minimum filtering level profile must have the PR2PR library category set up to be blocked.

Block Specified Entities from Using IM, P2P

Block IM for a Specific Entity

To block IM for a specified group or user:

- the Pattern Blocking option in the Filter window must be activated
- the CHAT and specified individual Instant Messaging library categories must **both** be set up to be blocked for that entity
- the global filtering profile should **not** have IM blocked, unless blocking all IM traffic with the Range to Detect feature is desired
- the minimum filtering level profile should **not** have IM blocked, unless blocking all IM traffic with the Range to Detect feature is desired.

Block P2P for a Specific Entity

To block P2P for a specified group or user:

- the Pattern Blocking option in the Filter window must be activated
- the PR2PR library category must be set up to be blocked for that entity
- the global filtering profile should **not** have P2P blocked, unless blocking all P2P traffic with the Range to Detect feature is desired
- the minimum filtering level profile should **not** have P2P blocked, unless blocking all P2P traffic with the Range to Detect feature is desired.

Chapter 3: Synchronizing Multiple Units

Web Filter Synchronization

The Web Filter can function in one of three modes—“Stand Alone” mode, “Source” mode, or “Target” mode—based on the setup within your organization. In a multi-Web Filter environment, all Web Filters should be set up with the same user profile data, so that no matter which Web Filter a user’s PC accesses on the network, that user’s Internet usage is appropriately filtered and blocked. The act of configuring multiple Web Filters to share the same user profile information is known as synchronization.

The synchronization feature allows an administrator to control multiple Web Filters without the need to configure each one independently. Web Filter synchronization uses a source/target configuration, in which one Web Filter is designated as the source server on which all configuration entries are made. All other Web Filters on the network are configured as target servers to the source Web Filter unit, receiving updates from the source server.

FUNCTIONAL MODES

Stand Alone Mode

In the Stand Alone mode, the Web Filter functions as the only Internet filter on the network. This mode is used if there is only one Web Filter on the network. Synchronization does not occur in this mode.

Source Mode

The Source mode is used in synchronization. In this mode the Web Filter is configured to not only function as a content filter, but also to act as a Centralized Management Console for all other Web Filters on the network. Whenever a filtering configuration change is made on the source Web Filter, that change is sent to all target Web Filters that have been identified by the source unit via the Synchronization Setup window of the Web Filter console. This means that all filtering configuration should be made on the source Web Filter. This also means that any user-level filter authentication should be performed on the source Web Filter so that these filtering changes can be disseminated to all Web Filter target units.



NOTE: *If the failover detection synchronization feature is enabled, if a target server fails, the source server can be set up to detect the failed server and perform filtering for that server.*

Target Mode

As in the Source mode, the Target mode is used in synchronization. In this mode, filtering information from the source server will be uploaded to the target server. The only synchronization setup that needs to be made on the target server is to ensure that network interfaces are configured for network communication.

Synchronization Setup

To set up synchronization on a Web Filter, a selection must be made in Setup window from the System section of the Web Filter console to specify whether the Web Filter will function as a source server or as a target server. This selection affects the contents that display in the Setup window.



NOTE: *This version of synchronization only supports the use of unique IP addresses throughout a network.*

Setting up a Source Server

When setting up an Web Filter to function as a source server, an IP address must be entered for each target Web Filter unit. This entry identifies the location of each target unit on the network.



NOTE: *If synchronizing from a standalone Web Filter to an M86 WFR server, please consult the chart at http://www.m86security.com/software/8e6/hlp/r3000/files/1system_sync_versions.html for software version compatibility between the two products.*



WARNING: *If an Web Filter is set up in the Source mode with a Network Address Translation (NAT) device between the source and target server(s), be sure that ports 26262, 26268, and 88 are open on the source server. This setup is required so that the source server can communicate with the target server(s).*

Setting up a Target Server

When setting up a Web Filter to function as a target server, the IP address of the source server must be entered to identify the source server on the network. This IP address is used for security purposes, as the target server will only acknowledge and apply changes it receives from the designated source server. Additionally, this IP address is used by the target server to identify the source server from which it

should receive its running filter configuration in the event of a reboot.



WARNING: *If a Web Filter server is set up in the Target mode with a NAT device between the target and source server, be sure that ports 26262 and 26268 are open on the target server. This setup is required so that the target server can communicate with the source server.*

Types of Synchronization Processes

Synchronization involves two types of processes: filtering profile synchronization, and library synchronization.

Filtering Profile Synchronization Process

In the filtering profile synchronization process, if a filtering change is made on the source server—whether the update is a global, IP, LDAP, minimum filtering bypass activation, or user profile update—the change is applied locally. Once locally applied on the source server, this update is sent to all target Web Filters. Each target server will then immediately apply this filtering change. The result is that profile updates occur on all Web Filter units in near real time.

In the event that a target server is unable to communicate with the source server, the target server will continue to run the last known configuration it received from the source server. The only exception to this scenario is that active profiles—such as LDAP or override accounts—will not run on the target server, since active profiles are timed out after a specified period of time. However, all IP based filters—such as the minimum filtering level, and the global rule that was last received from the source server—will be applied. When the target server resumes communication with the source server, it will actively download and apply the latest running configuration from the source server.

If the target server is rebooted for any reason (loss of power etc.) upon bootup, the target server will actively download and apply the current running configuration from the source server. It will then also receive future changes made on the source server.

Library Synchronization Process

In the library synchronization process, if a library change is made on the source server, the change is applied locally. Once locally applied on the source server, this update will be placed in a queue for submission to target Web Filter servers. The source server will then send the information in the queue to all target servers. Each target server will receive this information and apply the update.

On the source server, a separate queue exists for each identified target server. A queue is used as a repository in the event of a communication failure between the source server and target server. Information remains in this queue and is submitted to the target server once communications are re-established. The use of queues ensures that if a target server is taken offline for a period of time, when it is brought back online, it will be updated with the latest changes from the source server.

Delays in Synchronization

When a filtering profile is applied to the source server, there is a slight delay in the time it takes to apply the profile to the target server. This delay is caused by the amount of time it takes the source server to process the change, prepare the update for submission, send the update, and finally to activate the update on the target server. In practice, this should only be matter of seconds. In essence, filtering profiles are shared in near real time with this factor being the only delay.

The delay in activating a library change can take a little longer than in activating a filtering profile change. This is due to the fact that the library on the Web Filter is loaded into the physical memory. When a change is made to the library, a new library must be loaded into memory with the changes. So the delay between the library change taking place is the net of the amount of time it takes the source server to prepare the update for submission, and then the amount of time it takes for the update to be sent, received, and processed by the target server. Once processed, the new library is loaded into memory and activated, while the old version of the library is removed from memory. The total time of this process will vary depending upon custom library entries, but the entire procedure should take approximately one minute.

Synchronized, Non-Synchronized Items

It is important to note that while some items are synchronized to the target Web Filters, they do not become permanent configurations on the target Web Filter. These items are in essence functionally synchronized, since they are configurations that the target Web Filters will read from the source Web Filter upon load. These items will then be updated on an as needed basis from the source Web Filter. For purpose of differentiation, these items will be referred to as functionally synchronized for purposes of this user guide. These functionally synchronized items will be available for use on the target Web Filter.

The following options are available for synchronization: Synchronize all items (both profile and library changes), and synchronize only library items.

As you will see by the lists on the following pages, static configuration options—such as library changes—will be synchronized. All active options—such as profile changes—will be functionally synchronized. One time configuration options on the Web Filter—such as reporting configurations, or IP addresses—will not be synchronized.

Synchronize All Items

The following lists show which items will be synchronized when the option to synchronize all items is selected.

Synchronized Items (All)

- M86 Library additions/deletions
- Custom library creations
- Custom library additions/deletions
- Search Engine keyword additions/deletions
- Keywords in URL additions/deletions
- Approved Content settings in the Global Group profile

Functionally Synchronized Items

- Common Customization, Block Page Authentication settings, Authentication Form Customization, Lock Page Customization, Warn Page Customization, Profile Control settings, Quota Block Page Customization, Quota Notice Page Customization
- Minimum Filtering Level
- Rules
- Global Group Profile
- Override Account: addition/deletion, activation/deactivation
- Lock Profiles
- IP User/Group and sub-group: additions/deletions, changes, filter changes
- LDAP User/Group: additions/deletions, changes, filter changes, profile activation/deactivation
- Category Weight System additions/deletions

- Quota Setting

Non-synchronized Items

- Filter control settings
- Virtual IP and Authentication IP addresses
- IP addresses
- Default routes
- Software Update application
- Synchronization settings
- Filter Mode
- Backup/Restore
- SNMP configuration
- Warn Option Setting
- Reporter configuration
- CMC Management
- SSL Certificate

Synchronize Only Library Items

The following lists show which items will be synchronized when the option to synchronize only library items is selected.

Synchronized Items (Library Only)

- M86 Library additions/deletions
- Custom library creations
- Custom library additions/deletions
- Search Engine keyword additions/deletions
- Keywords in URL additions/deletions

Functionally Synchronized Items

- Category Weight System additions/deletions

Non-synchronized Items

- Common Customization, Block Page Authentication settings, Authentication Form Customization, Lock Page Customization, Warn Page Customization, Profile Control settings, Quota Block Page Customization, Quota Notice Page Customization
- Minimum Filtering Level
- Rules
- Global Group Profile
- Override Account: addition/deletion, activation/deactivation
- Lock Profiles
- IP User/Group and sub-group: additions/deletions, changes, filter changes

- LDAP User/Group: additions/deletions, changes, filter changes, profile activation/deactivation
- Filter control settings
- Virtual IP and Authentication IP addresses
- IP addresses
- Default routes
- Software Update application
- Synchronization settings
- Filter Mode
- Backup/Restore
- Radius Authentication Settings
- SNMP configuration
- X Strikes Blocking settings
- Warn Option Setting
- Reporter configuration
- CMC Management
- SSL Certificate

Server Maintenance Procedures

Source Server Failure Scenarios

In the event that the source Web Filter unit should fail, the target servers will continue to run using the last known configuration loaded from the source server. However, all dynamic authentication-based profiles will eventually time-out, since the source Web Filter server can no longer verify user credentials. When this occurs, the information on the server can no longer be trusted. In most cases, the failure of the source server can be quickly repaired, though it is possible the source server will be down for an extended period of time due to detailed troubleshooting that needs to be performed, or that the source server will need to be replaced due to hardware failure.

In cases in which the source Web Filter server is out of commission for an extended period of time, this server should be replaced as soon as possible so that individual user authentication can be executed, and the ability to control the filtering cluster is continually enabled. In cases in which the Web Filter will not be immediately replaced, one of the target Web Filter servers should be designated as the new source server.

Establish Backup Procedures

To prevent down time during a source server failure, M86 recommends establishing backup and restore procedures. It is important that regular backups of the source Web Filter server are saved using the Backup/Restore window in the System section of the Web Filter console. Once a backup is created, it can be downloaded to another machine for safe-keeping. ***A backup should be created and downloaded whenever a change is made to filtering settings on the source Web Filter.***

Use a Backup File to Set up a Source Server

In the event of a source server failure, the global administrator should designate a target server as the new source server.

Set up a Target Server as a Source Server

1. Log in to the console of the target server designated as the new source server.
2. In the System section of the console, go to the Backup/Restore window and create a backup of the current running configuration on that server.
3. Download the server's configuration to a safe storage place until it is needed.
4. In the LAN Settings window (accessible via System > Network), set up IP addresses to be the same as on the source server that is being replaced.
5. Go to the Reboot window (accessible via System > Control) and reboot the server.
6. Once the Web Filter is rebooted, reconnect to the console and access the Backup/Restore window.
7. Upload the last good configuration from the failed source server to the new source server. When the configuration file is uploaded and available in the Web Filter console, that file should be used for restoring configuration settings.
8. After the restoration of configuration settings is applied and a quick reload takes place, this Web Filter will now function as the source server in the Web Filter cluster.

Set up a Replacement Target Server

Once the original source server is replaced or repaired, it can then be configured to replace the empty spot created by the movement of the target server to the position of source server. Configure this Web Filter so that the IP addresses are that of the target server which became the source server. Upload the running target configuration, which was downloaded prior to converting the target server to a source server. Use this configuration to create a duplicate of the target server that was moved. Once this step is complete, the cluster is whole again and should operate normally.

Set up a New Source Server from Scratch

In the event that you do not have a reliable backup file that can be used for establishing a new source server, you must recreate the settings on the new source server.

Set up a Target Server as a Source Server

1. Log in to the console of the target server designated as the new source server.
2. In the System section of the console, access the Reset window and click Reset to remove all settings on the server.
3. Enter all settings from the failed source server on this “new” server. In the Setup window (accessible via System > Synchronization), specify that this is a source server.
4. Apply all software updates that were applied on the failed source server.
5. In the Policy section of the console, enter all groups and filtering profiles.
6. Make all necessary settings in all sections and windows of the console.

Chapter 4: Getting Started

Initial Setup

To begin setting up your Web Filter server, follow the instructions in the M86 Web Filter Installation Guide, the booklet packaged with your Web Filter unit. This guide explains how to perform the initial configuration of the server so that it can be accessed via an IP address or host name on your network, and the SSL certificate for the Web Filter generated to ensure a secure network connection.



NOTE: *If you do not have the M86 Web Filter Installation Guide, contact M86 Security immediately to have a copy sent to you.*

Access the Administrator Console

Log On

1. Launch an Internet browser window supported by the Web Filter.
2. In the address line of the browser window, type in “https://” and the Web Filter server’s IP address or host name, and use port number “:1443” for a secure network connection, plus “/login.jsp”.

For example, if your IP address is 210.10.131.34, type in **https://210.10.131.34:1443/login.jsp**. Using a host name example, if the host name is logo.com, type in **https://logo.com:1443/login.jsp**.

With a secure connection, the first time you attempt to access the Web Filter’s user interface in your browser you will be prompted to accept the security certificate. In order to accept the security certificate, follow the instructions at: **<http://www.m86security.com/software/8e6/docs/ig/misc/sec-cert-wf4.2.pdf>**

- After accepting the security certificate, click **Go** to open the Web Filter login window:

 A screenshot of the Web Filter login window. The window has a title bar with "Web Filter" and the "M86 SECURITY" logo. Below the title bar, there are two input fields: "Username:" with the text "admin" entered, and "Password:" with four dots representing a masked password. A "LOGIN" button is positioned below the password field.

Fig. 1:4-1 Login window

- Enter your **Username** and **Password**.



TIP: The default Username is **admin** and the Password is **user3**. To change this username and password, go to the Administrator window (see the Administrator window of the System screen in the Global Administrator Section) and create a global administrator account.



NOTE: See Chapter 1: System screen in the Global Administrator Section for information on logging into the Web Filter user interface if your password has expired.

- Click **LOGIN** to access the welcome screen of the Administrator console:



Fig. 1:4-2 Welcome screen

On this screen, the Web Filter Version Number displays in the Product frame, and dates for the Last Software Update and Last Library Update display in the Web Filter Status frame.

The following information displays at the bottom of the Administrator console: Host Name, LAN IP address used for sending block pages, and software Version number.

Last Library Update message

If it has been more than seven days since the Web Filter last received updates to library categories, upon logging into the Administrator console a pop-up dialog box opens and displays the following message: "Libraries were last updated more than 7 days ago. Do you want to update your libraries now?" Click either Yes or No to perform the following actions:

- **Yes** - clicking this button closes the dialog box and opens an alert box indicating that it will take a few minutes to perform the library update. Click **OK** to close the alert box and to execute the command to update the libraries. After the libraries are updated, today's date will appear as the Last Library Update on the welcome screen.



NOTE: Refer to the Library screen's Manual Update to M86 Supplied Categories window—in the Global Group Section—for information about updating library categories on demand.

- **No** - clicking this button closes the dialog box and displays the welcome screen with the Last Library Update and the following message below in purple colored text: "Libraries were last updated 7 days ago. Please use the Weekly Update option":

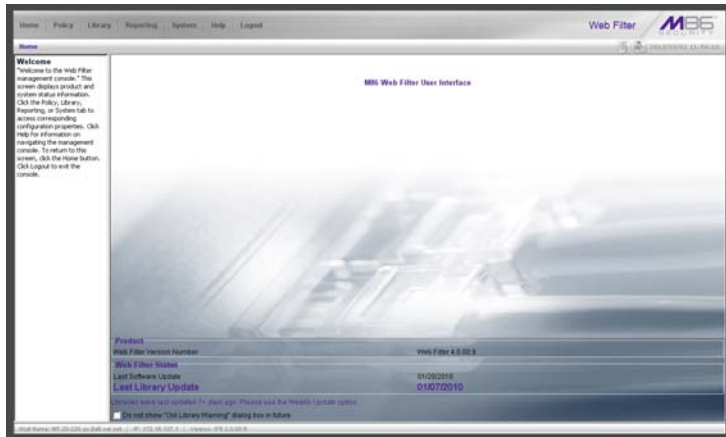

Fig. 1:4-3 Welcome screen, Last Library Update text

Click the checkbox “Do not show “Old Library Warning” dialog box in future” to disable the Last Library Update message pop-up box. After the libraries are updated, the welcome screen will appear as in Fig. 1:4:2 with today’s date as the Last Library Update in black text.

Navigation Tips

Access Main Sections

The Administrator console is organized into six sections, each accessible by clicking the corresponding link in the navigation toolbar at the top of the screen:

- **Home** - clicking this link displays the Welcome screen of the Administrator console.
- **Policy** - clicking this link displays the main screen for the Policy section. Windows in the Policy section are used for creating and managing master IP groups, sub-groups, and individual IP filtering profiles, or for setting up LDAP domains, groups, and individual users, and their filtering profiles.
- **Library** - clicking this link displays the main screen for the Library section. Library section windows are used for adding and maintaining library categories. Library categories are used when creating or modifying a filtering profile.
- **Reporting** - clicking this link displays the main screen for the Reporting section. The Reporting section contains windows used for configuring reports on users' Internet activities.
- **System** - clicking this link displays the main screen for the System section. This section is comprised of windows used by the global administrator for configuring and maintaining the server to authenticate users, and to filter or block specified Internet content for each user based on the applied filtering profile.

- **Help** - clicking this link displays the Help screen that includes navigation tips. Links in the left panel provide access to software and appliance information, and a page for downloading the latest documentation (in the .pdf format):

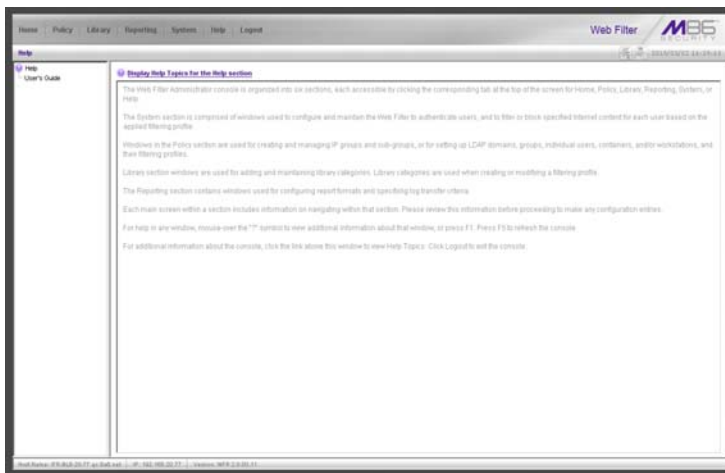

Fig. 1:4-4 Help screen

- **Logout** - click this link to log out of this application. When your session has been terminated, the login window re-displays.

Note that on each screen, in the right side of the banner, the following displays:



X Strikes Blocking icon - If the X Strikes Blocking feature is enabled, this icon can be clicked by authorized users to access the X Strikes Unlock Workstation window where workstations are unlocked.



Real Time Probe icon - If the Real Time Probe feature is enabled, this icon can be clicked by authorized users to access the Real Time Probe reporting tool.

- system time - The system time displays using the YYYY/MM/DD HH:MM:SS date and time format

Help Features

Help features provide information about how to use windows in the Administrator console. Such features include help topics and tooltips.

Access Help Topics

Each of the main section screens contains a link beneath the banner. When that link is clicked, a separate browser window opens with Help Topics for that section:

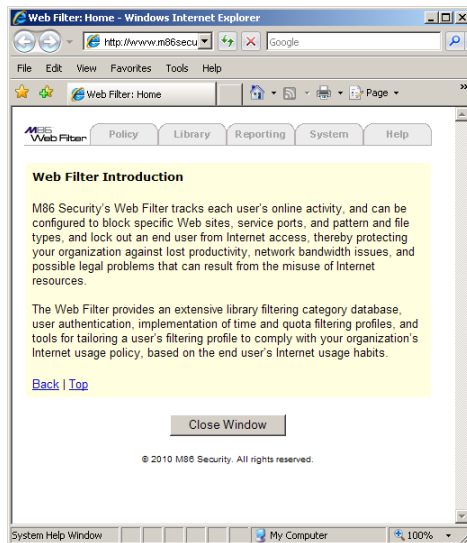



Fig. 1:4-5 Help Topics window

1. Click a link to go to a specified topic.
2. To view Help Topics for another section, click the tab for that section: Policy, Library, Reporting, System, or Help.
3. Click **Close Window** to close the Help Topics window.

Tooltips

In any window that features the  icon in the navigation path bar beneath the banner, additional information about that window can be obtained by hovering over that icon with your mouse, or by pressing the **F1** key on your keyboard.

- **Hover Display**

The yellow tooltip box displays when you hover over the icon with your mouse:



Fig. 1:4-6 Tooltip mouseover effect

To close the tooltip box, move the mouse away from the icon.

- **Help pop-up box**

The Help pop-up box opens when you press the **F1** key on your keyboard:

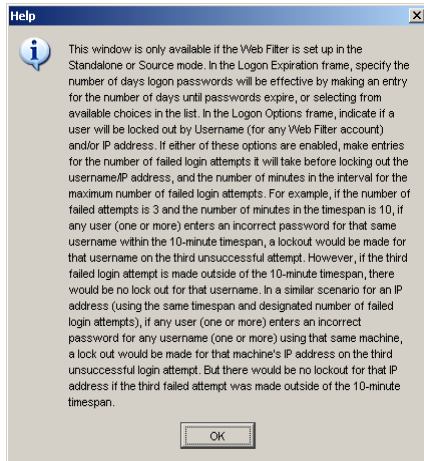

Fig. 1:4-7 Help pop-up box

Click **OK** to close the pop-up box.

Screen and Window Navigation

All screens are divided into two panels: a navigation panel to the left, and a window in the panel to the right. Windows display in response to a selection made in the navigation panel.

In the Administrator console, screens and windows use different navigation formats, based on the contents of a given screen or window. Screens can contain topic links and sub-topic menus, and/or tree lists with topics and sub-topic menus. Windows can contain tabs that function as sub-windows.

Topic Links

In Library, Reporting, and System screens, the navigation panel contains topic links. By clicking a topic link, the window for that topic displays in the right panel:

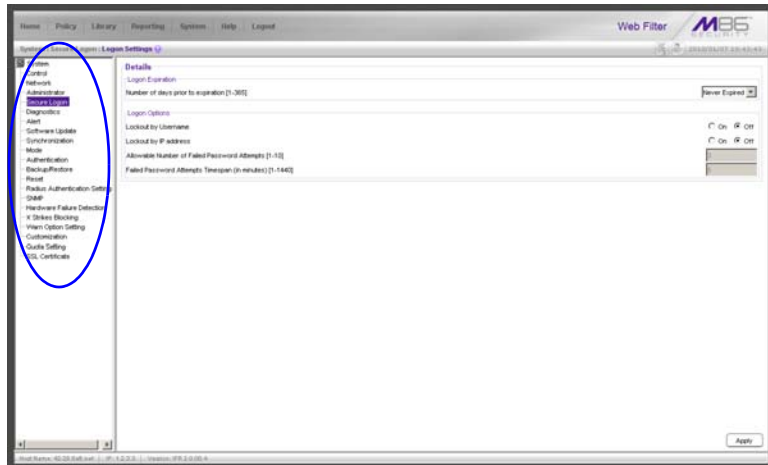

Fig. 1:4-8 Selected topic and its corresponding window

Select Sub-topics

Some topics in Library and System screens consist of more than one window. For these topics, clicking a topic link opens a menu of sub-topics:

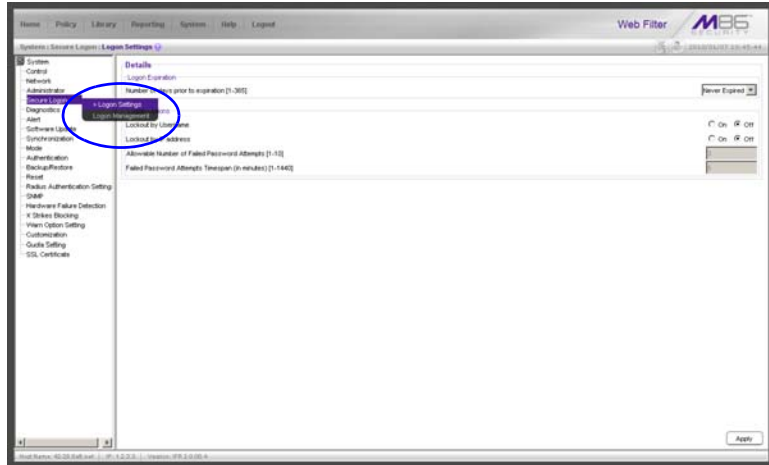

Fig. 1:4-9 Sub-topics menu

When a sub-topic from this menu is selected, the window for that sub-topic displays in the right panel of the screen.

Navigate a Tree List

Tree lists are included in the navigation panel of Policy and Library screens.

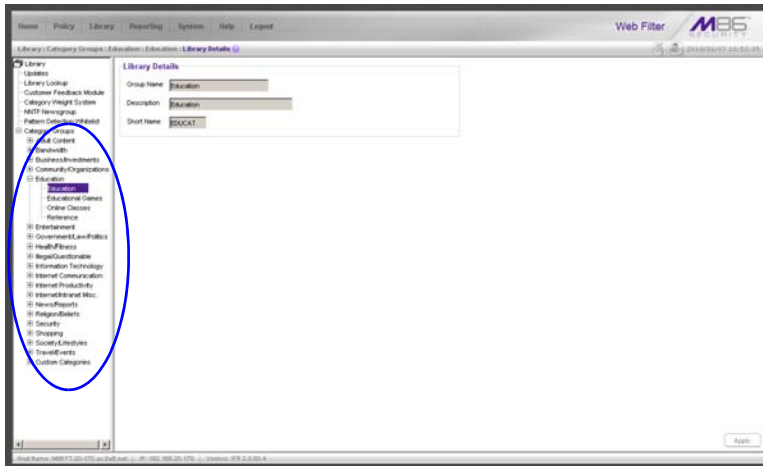

Fig. 1:4-10 Tree menu

A tree is comprised of a hierarchical list of items. An entity associated with a branch of the tree is preceded by a plus (+) sign, when that branch of the tree is collapsed.

By double-clicking the entity, a minus (-) sign replaces the plus sign, and all branches within that branch of the tree display.

An item in the tree is selected by clicking it.

Tree List Topics and Sub-topics

Policy and Library tree lists possess a menu of topics and sub-topics.

Topics in the tree list display by default when the tree is opened. Examples of tree list topics are circled in Fig. 1:4-11.

When a tree list topic is selected and clicked, a menu of sub-topics opens:

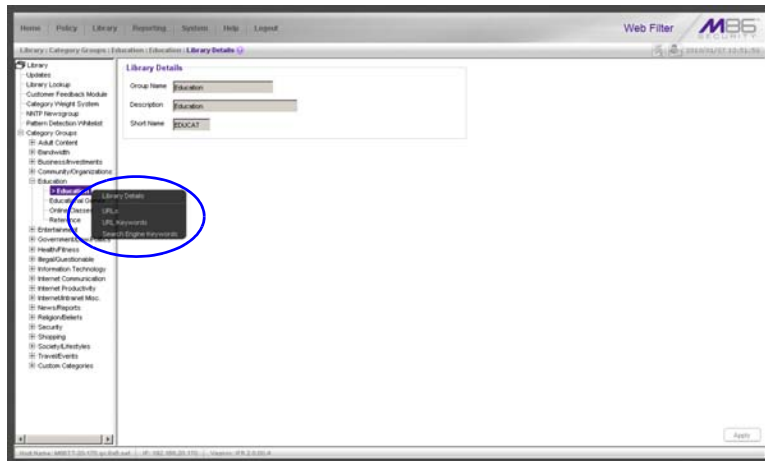

Fig. 1:4-11 Tree list topics and sub-topics

Clicking a sub-topic displays the corresponding window in the right panel, or opens a pop-up window or alert box, as appropriate.

Navigate a Window with Tabs

In each section of the console, there are windows with tabs.

When selecting a window with tabs from the navigation panel, the main tab for that window displays. Entries made in a tab must be saved on that tab, if the tab includes the Apply button.



NOTE: In the Time Profile and Override Account pop-up windows, entries are saved at the bottom of the window.

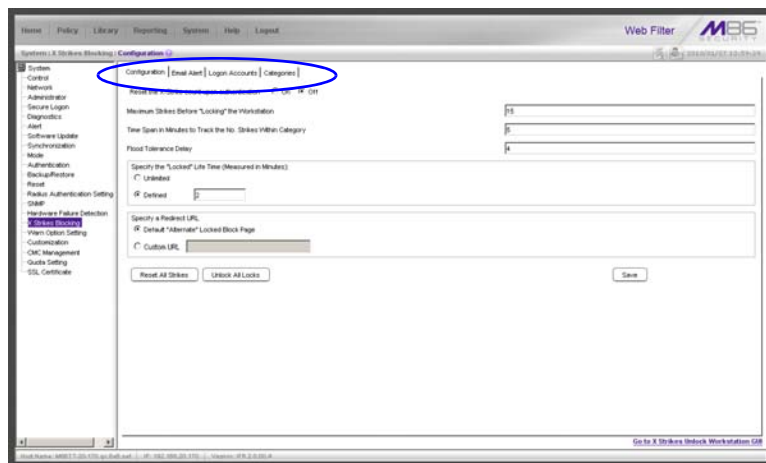

Fig. 1:4-12 Window with tabs

Console Tips and Shortcuts

The following list of tips and shortcuts is provided to help you use windows in the Administrator console with greater efficiency.

Navigation Path

The navigation path displays at the top of each window:

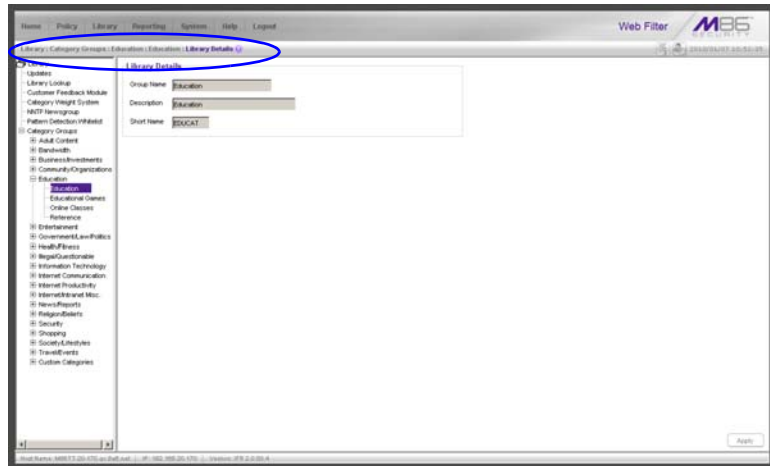

Fig. 1:4-13 Navigation path

This path reminds you of your location in the console. The entire path shows the screen name, followed by the topic name, and sub-topic name if applicable.

Refresh the Console

Press **F5** on your keyboard to refresh the Administrator console. This feature is useful in the event that more than one browser window is open simultaneously for the same Web Filter.

Select Multiple Items

When moving several items from one list box to another, or when deleting several items, the Ctrl and Shift keys can be used to expedite this task.

- **Ctrl Key**

To select multiple items from a list box, click each item while pressing the Ctrl key on your keyboard.

- **Shift Key**

To select a block of items from a list box, click the first item, and then press the Shift key on your keyboard while clicking the last item.

Once the group of items is selected, click the appropriate button to perform the action on the items.

Copy and Paste Text

To save time when making duplicate data entries, text previously keyed into the GUI can be copied and pasted into other fields without needing to key in the same text again.

- **Copy command**

Copy text by using the cursor to highlight text, and then pressing the **Ctrl** and **C** keys on the keyboard.

- **Paste command**

Text that was just copied from a field can be pasted into another field that is either blank or populated with text.

- To paste text into an empty field, place the cursor in the field and then press the **Ctrl** and **V** keys.
- To copy over existing text, highlight text currently in the field and then press the **Ctrl** and **V** keys.

Calculate IP Ranges without Overlaps

The Calculator button displays on windows in which IP ranges are entered. These windows include: Range to Detect and Members windows from the Policy section, and Block Page Route Table window from the System section.

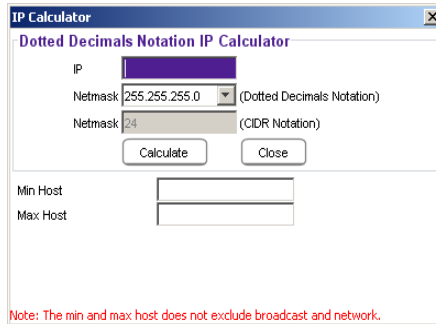



Fig. 1:4-14 IP Calculator pop-up window

This window is used to view and/or calculate the minimum and maximum range for an IP address.

1. Click **Calculator** to open the IP Calculator pop-up window.
 - If the IP address field in the window on the console is already populated, note the IP Calculator pop-up window displays the IP address, default Netmask in both the Dotted Decimals Notation (e.g. “255.255.255.248”) and CIDR Notation (e.g. “29”) format, Min Host, and Max Host IP addresses.
 - If the IP address field in the window on the console is empty, in this pop-up window enter the **IP** address, specify the Dotted Decimals Notation **Netmask**, and then click **Calculate** to display the Min Host and Max Host IP addresses.

 **TIP:** If necessary, make a different IP address entry and Netmask selection, and then click **Calculate** to display different Min Host and Max Host results.

2. After making a note of the information in this pop-up window, click **Close** to close the IP Calculator.

Re-size the User Interface

For greater ease in viewing content in any screen, re-size the browser window by placing your cursor at any edge or corner of the user interface, left clicking, and then dragging the cursor to the left or right, or inward or outward.

Log Off

To log off the Administrator console:

1. Click the **Logout** button in the navigation toolbar at the top of the screen. This action opens the Quit dialog box:

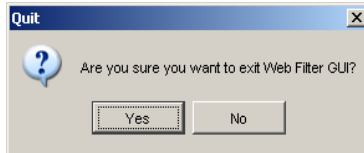

Fig. 1:4-15 Quit dialog box

2. Click **Yes** to return to the Login window.
3. Click the “X” in the upper right corner of the screen for the Login window to close it



WARNING: If you need to turn off the server, see the *ShutDown* window of the *System* screen in the *Global Administrator* Section.

Technical Support / Product Warranties

For technical assistance or warranty repair, please visit <http://www.m86security.com/support/> .

GLOBAL ADMINISTRATOR SECTION

Introduction

The Global Administrator Section of this user guide is comprised of four chapters, based on the layout of the Administrator console. This section is used by the authorized global administrator of the Web Filter for configuring and maintaining the Web Filter server.

The global administrator is responsible for integrating the server into the existing network, and providing the server a high-speed connection to remote client workstations and to a reporting application, if pertinent. To attain this objective, the global administrator performs the following tasks:

- provides a suitable environment for the server, including:
 - Hypertext Transfer Protocol over Secure Socket Layer (HTTPS) link to the current logging device
 - power connection protected by an Uninterruptible Power Supply (UPS)
 - high speed access to the server by authorized client workstations
- adds group administrators
- sets up administrators for receiving automatic alerts
- updates the server with software supplied by M86
- analyzes server statistics
- utilizes diagnostics for monitoring the server status to ensure optimum functioning of the server
- configures the server for authenticating users
- adds and maintains filtering categories
- adds and maintains filtering profiles of entities

Chapter 1: System screen

The System screen is comprised of windows used for configuring and maintaining the server to authenticate users, and to filter, log, or block specified Internet content for each user based on an applied filtering profile.

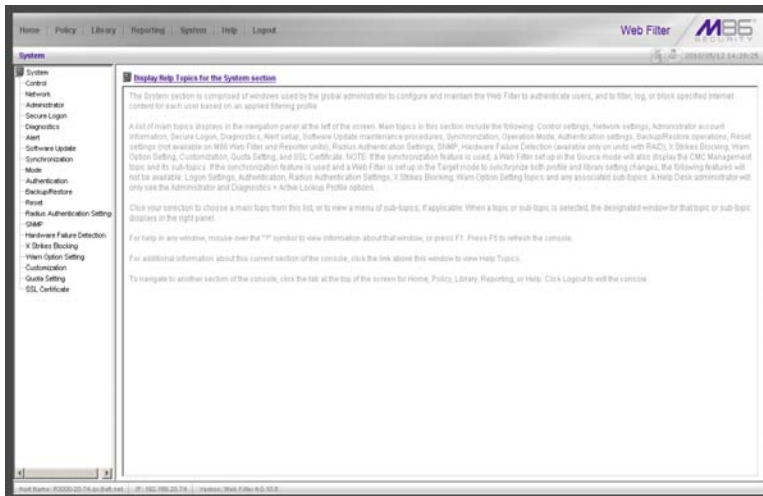

Fig. 2:1-1 System screen

A list of main topics displays in the navigation panel at the left of the screen. Main topics in this section include the following: Control settings, Network settings, Administrator account information, Secure Logon, Diagnostics, Alert contacts, Software Update, Synchronization, operation Mode, Authentication settings (see the M86 Web Filter Authentication User Guide for information about this topic), Backup/Restore operations, Reset settings, Radius Authentication Settings, SNMP, Hardware Failure Detection, X Strikes Blocking, Warn Option Setting, Customization, Quota Setting, and SSL Certificate.



NOTES: *If the synchronization feature is used and a Web Filter is set up in the Source mode, the CMC Management topic and associated sub-topics are also available.*

If the synchronization feature is used and a Web Filter is set up in the Target mode to synchronize both profile and library setting changes, settings in the Filter window and Customization windows cannot be edited, and the following topics and any associated sub-topics are not available: Block Page Authentication, Authentication, Radius Authentication Settings, X Strikes Blocking, and Warn Option Setting. If a Web Filter is set up in the Target mode to synchronize only library setting changes, all topics and sub-topics are available.

A help desk administrator will only see the Administrator and Diagnostics topics.

Click your selection to choose a main topic from this list, or to view a menu of sub-topics, if applicable. When a topic or sub-topic is selected, the designated window for that topic or sub-topic displays in the right panel.

Control

Control includes options for controlling basic Web Filter server functions. Click the Control link to view a menu of sub-topics: Filter, Block Page Authentication, ShutDown, and Reboot.

Filter window

The Filter window displays when Filter is selected from the Control menu. This window is used for specifying network filtering preferences on this server.

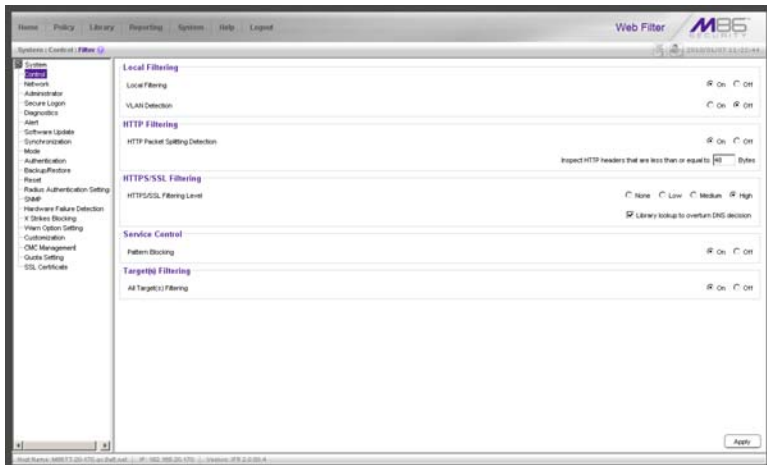

Fig. 2:1-2 Filter window

Local Filtering is used for specifying whether this server being configured will filter traffic on the network. If enabling the HTTP Filtering feature that automatically detects a split packet, HTTP headers less than or equal to the number of bytes specified will be inspected. HTTPS Filtering lets you set the level of filtering for HTTPS sites on Web Filters set up in the Stand Alone or Source mode. In the Service Control frame, enabling Pattern Blocking will log IM and P2P end user activity, and block end users from using

clients such as Google Web Accelerator and proxy patterns that bypass filtering (see http://www.m86security.com/software/8e6/hlp/r3000/files/1system_proxy_block.html for a list of proxy pattern types set up to be blocked. When using this feature, the Pattern Detection Whitelist window can be used for setting up IP addresses to bypass pattern filtering (see Pattern Detection Whitelist window in Chapter 3: Library screen). Target(s) Filtering will only display if this server being configured is set up for synchronization in the Source mode. This frame is used for specifying whether filtering will take place on all Web Filter servers on the network set up in the Target mode.



NOTE: *This window displays greyed-out if the synchronization feature is used, and this server being configured is set up in the Target mode to synchronize both profile and library setting changes.*



TIP: *See the Introductory Section for overviews on the following topics:*

- *IM and P2P (Chapter 2: Logging and Blocking)*
- *Synchronization (Chapter 3: Synchronizing Multiple Units)*

Local Filtering

In the Local Filtering frame, indicate the function of this server being configured, in regards to filtering the network. The default setting has **Local Filtering** “On” and **VLAN Detection** “Off”.

Disable Local Filtering Options

If you have multiple Web Filters on the network, you may wish to disable local filtering on the source server and use the server primarily for authenticating users who log on the network. This frees up resources on the server.

To disable **Local Filtering** and/or **VLAN Detection**, click the “Off” radio button(s).

Enable Local Filtering Options

To enable **Local Filtering**, click “On”. The server will filter the specified Range to Detect on the network.

To enable the detection of VLAN traffic on the network, at **VLAN Detection**, click “On”.



NOTE: After making all entries in this window, click **Apply**.

HTTP Filtering

In the HTTP Filtering frame, enable or disable the feature that automatically detects a split HTTP packet.

Enable HTTP Packet Splitting Detection

By default, the feature that automatically detects a split HTTP packet is disabled.

1. Click “On” to enable **HTTP Packet Splitting Detection**; this action displays a field below the radio buttons.
2. In the **Inspect HTTP headers that are less than or equal to ___ Bytes** field, by default 48 displays for the number of bytes. This entry can be modified to specify a different number of bytes for HTTP header inspection.

Disable HTTP Packet Splitting Detection

To disable automatic detection of a split HTTP packet, click “Off.” This action removes the field below the radio buttons.



NOTE: After making all entries in this window, click **Apply**.

HTTPS Filtering

Specify your preference for filtering HTTPS sites in the HTTPS Filtering frame. Select from the following settings for the **HTTPS Filtering Level**:

- “None” - if you do not want the Web Filter to filter HTTPS sites
- “Low” - if you want the Web Filter to filter HTTPS sites without having the Web Filter communicate with IP addresses or hostnames of HTTPS servers
- “Medium” - if you want the Web Filter to communicate with HTTPS servers in order to get the URL from the certificate for URL validation only (this is the default setting)

If "Medium" is selected, by default the option is enabled for forwarding the DNS lookup in order to validate the hostname in the certificate

- “High” - if you want the Web Filter to communicate with HTTPS servers to obtain the certificate with a very strict validation of the return URL

If "High" is selected, by default the option is enabled for a library lookup to overrule the DNS validation of the host-name in the certificate.



WARNING: *If using the “High” setting, end users may be blocked from accessing acceptable Web sites if the host names of these sites do not match their generated certificates. To allow users access to acceptable HTTPS sites, the IP addresses and corresponding URLs of these sites should be included in a custom library category that is allowed to pass. (See the Custom library category sub-section in Chapter 2: Library screen from the Group Administrator Section for information on setting up a custom library category. See Global Group Profile window and Minimum Filtering Level window in Chapter 2: Policy screen from the Global Administrator Section for information on allowing a library category to pass.)*



NOTE: After making all entries in this window, click **Apply**.

Service Control

In the Service Control frame, indicate whether or not Pattern Blocking will be enabled or disabled.

Enable Pattern Blocking

By default, **Pattern Blocking** is disabled. Click “On” to block the usage of clients such as Google Web Accelerator and various proxy pattern types on end user workstations that bypass filtering, and to log IM and P2P activity of end users once IM and P2P pattern files are downloaded on demand via the Manual Update to M86 Supplied Categories window.



NOTE: See http://www.m86security.com/software/8e6/hlp/r3000/files/1system_proxy_block.html for a list of proxy pattern types that are set up to be blocked.



TIPS: To block specified users from accessing proxy patterns, the M86 supplied “PROXY” library category (Web-based Proxies/Anonymizers) must be applied to the group or user’s filtering profile. Or, to block all users from accessing these proxy patterns, the global filtering profile and minimum filtering level must have the “PROXY” library category set up to be blocked.

To block specified users from accessing IM services, “CHAT” and specified Instant Messaging M86 supplied library categories (such as “IMGEN”, “IMGCHAT”, “IMGTALK”, “ICQAIM”, “IMMSN”, “IMMYSP”, and/or “IMYAHOO”) must be applied to the group or user’s filtering profile. Or, to block all users from accessing IM services, the global filtering profile and minimum filtering level must have “CHAT” and appropriate Instant Messaging library categories set up to be blocked.

Additionally, to block specified users from accessing P2P services, the M86 supplied “PR2PR” library category must be applied to the group or user’s filtering profile. Or, to block all users from accessing P2P services, the global filtering profile and minimum filtering level must have the “PR2PR” library category set up to be blocked.

To create a whitelist of pattern IP addresses, see the *Pattern Detection Whitelist* window in Chapter 3: Library screen.

Disable Pattern Blocking

Click “Off” to disable **Pattern Blocking**.



NOTE: After making all entries in this window, click **Apply**.

Target(s) Filtering

The Target(s) Filtering frame only displays if the Web Filter currently being configured is set up in the Source mode for synchronization. The default setting has **All Target(s) Filtering** “On”.

Disable Filtering on Target Servers

To disable **All Target(s) Filtering**, click the “Off” radio button. Each target server on the network will not filter the Range to Detect specified on that server.

Enable Filtering on Target Servers

To enable **All Target(s) Filtering**, click the “On” radio button. Each target server on the network will filter the Range to Detect specified on that server.



NOTE: After making all entries in this window, click **Apply**.

Block Page Authentication window

The Block Page Authentication window displays when Block Page Authentication is selected from the Control menu. This feature is used for entering criteria the Web Filter will use when validating a user’s account. Information entered/ selected in this window is used by the block page that displays when an end user attempts to access a site or service that is set up to be blocked.

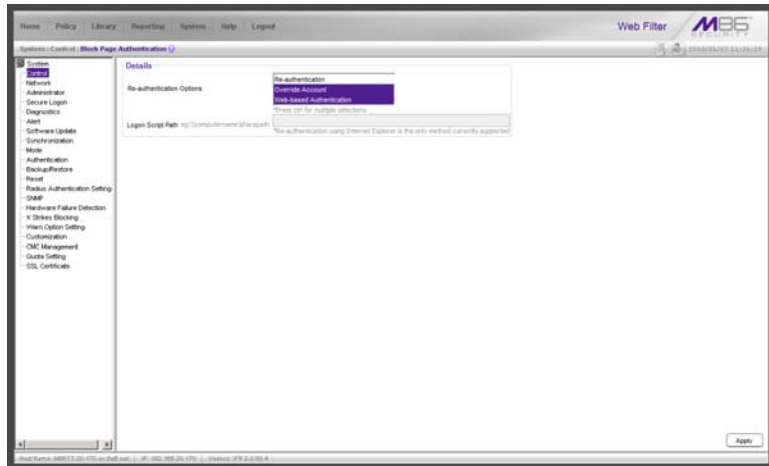

Fig. 2:1-3 Block Page Authentication window



NOTE: This feature is not available if the synchronization feature is used, and this server being configured is set up in the Target mode to synchronize both profile and library setting changes.

See the Block Page Customization window and Common Customization window in this chapter for information on customizing the M86 block page. See Appendix B: Create a Custom Block Page for information on creating a customized block page using your own design.

Enter, Edit Block Page Options



NOTE: *If you are not using authentication, and/or if your users do not have override accounts set up, you do not need to select any option at the Re-authentication Options field.*



TIP: *Multiple options can be selected by clicking each option while pressing the Ctrl key on your keyboard.*

1. In the **Re-authentication Options** field of the Details frame, choose from the following options by clicking your selection:

- **Web-based Authentication** - select this option if using Web authentication with time-based profiles or persistent login connections for LDAP authentication methods.
- **Override Account** - select this option if any user has an Override Account, allowing him/her to access URLs set up to be blocked at the global or IP group level.
- **Re-authentication** - select this option for the re-authentication option. The user can restore his/her profile and NET USE connection by clicking an icon in a window to run a NET USE script.



NOTES:

- *Details about the Web-based Authentication option can be found in the M86 Web Filter Authentication User Guide.*
- *For more information about the Override Account option, see information on the following windows in this user guide:*
 - *Global Administrator Section: Override Account window and Bypass Option window for the global group*
 - *Group Administrator Section: Override Account window for IP groups, and Exception URL window for IP groups.*
- *The Re-authentication option only supports Internet Explorer browsers. End users who are using other browser types (Firefox, Safari, Chrome, etc.) will not be able to re-authenticate themselves.*

2. If the Re-authentication option was selected, in the **Logon Script Path** field, \\PDCSHARE\scripts displays by default. In this field, enter the path of the logon script that the Web Filter will use when re-authenticating users on the network, in the event that a user's machine loses its connection with the server, or if the server is rebooted. This format requires the entry of two backslashes, the authentication server's computer name (or computer IP address) in capital letters, a backslash, and name of the share path.
3. Click **Apply** to apply your settings.

Block page

When a user attempts to access Internet content set up to be blocked, the block page displays on the user's screen:

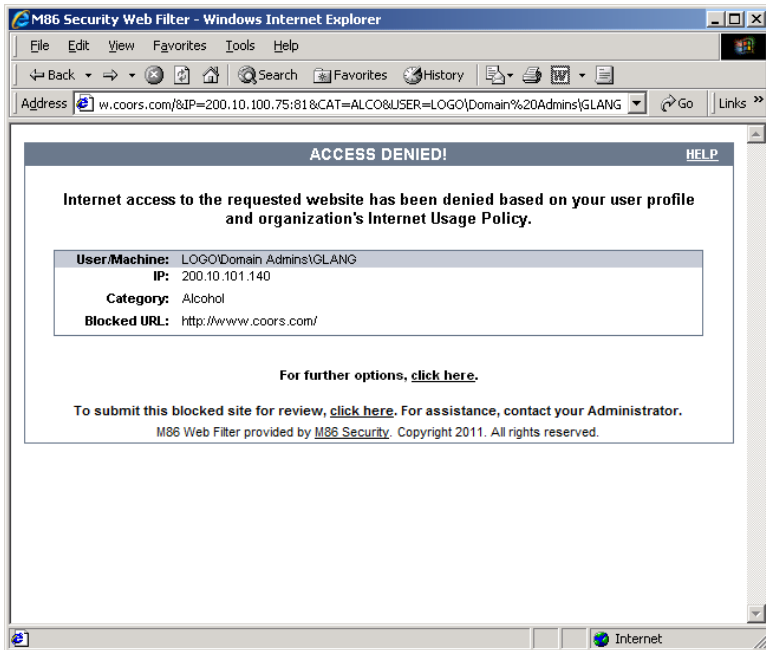

Fig. 2:1-4 Sample Block Page

By default, the following data displays in the User/Machine frame of the block page:

- **User/Machine** field - The username displays for the LDAP user. This field is blank for the IP group user.
- **IP** field - The user's IP address displays.
- **Category** field - The name of the library category that blocked the user's access to the URL displays. If the content the user attempted to access is blocked by an Exception URL, "Exception" displays instead of the library category name.
- **Blocked URL** field - The URL the user attempted to access displays.

By default, the following standard links are included in the block page:

- **HELP** - Clicking this link takes the user to M86's Technical Support page that explains why access to the site or service may have been denied.
- **M86 Security** - Clicking this link takes the user to M86's Web site.

By default, these links are included in the block page under the following conditions:

- **For further options, [click here](#).** - This phrase and link is included if any option was selected at the Re-authentication Options field. Clicking this link takes the user to the Options window, described in the Options page subsection that follows.
- **To submit this blocked site for review, [click here](#).** - This phrase and link is included if an email address was entered in the Submission Email Address field in the Common Customization window. Clicking this link launches the user's default email client. In the composition window, the email address from the Submission

Email Address field populates the “To” field. The user’s message is submitted to the global administrator.

Options page

The Options page displays when the user clicks the following link in the block page: **For further options, [click here](#).**

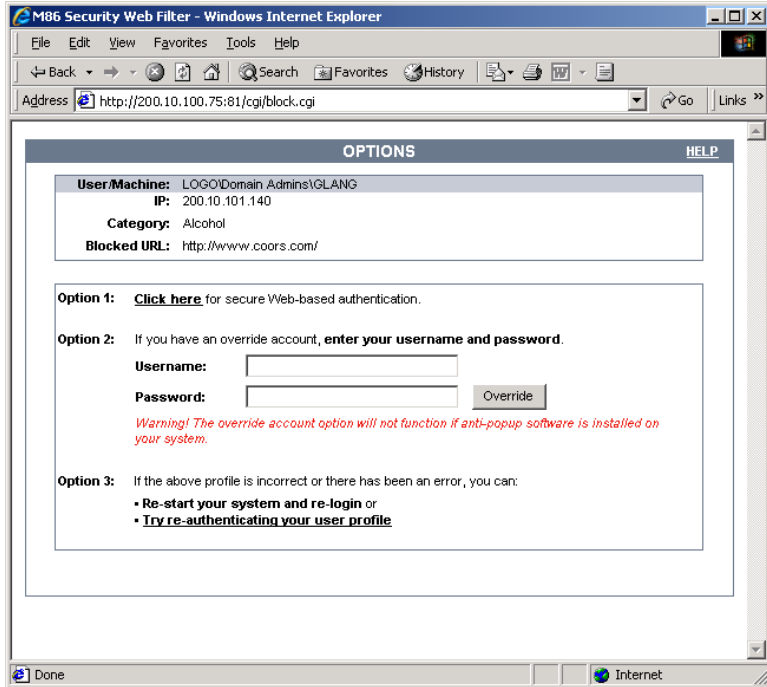

Fig. 2:1-5 Options page

The following items previously described for the Block page display in the upper half of the Options page:

- **HELP** link
- User/Machine frame contents

The frame beneath the User/Machine frame includes information for options (1, 2, and/or 3) based on settings made in this window and the Common Customization window.



NOTE: Information about Option 1 is included in the M86 Web Filter Authentication User Guide.

Option 2

Option 2 is included in the Options page, if “Override Account” was selected at the Re-authentication Options field.

This option is used by any user who has an override account set up for him/her by the global group administrator or the group administrator. An override account allows the user to access Internet content blocked at the global or IP group level.

The user should enter his/her **Username** and **Password**, and then click **Override** to open the Profile Control pop-up window:

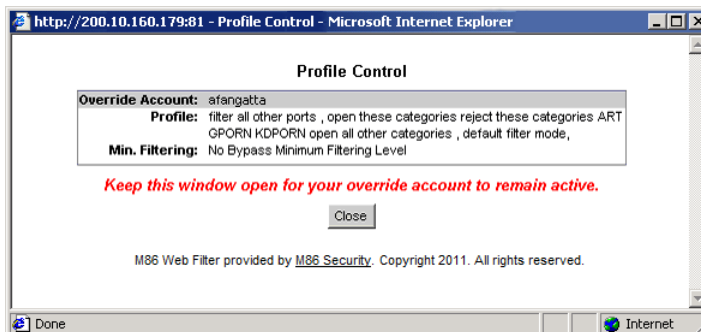

Fig. 2:1-6 Profile Control pop-up window

This pop-up window must be left open throughout the user’s session in order for the user to be able to access blocked Internet content.



NOTES: See Profile Control window for information on customizing the content in the Profile Control pop-up window. See Appendix C: Override Pop-up Blockers for information on how a user with an override account can authenticate if a pop-up blocker is installed on his/her workstation.

Option 3

The following phrase/link displays, based on options selected at the Re-authentication Options field:

- **Re-start your system and re-login** - This phrase displays for Option 3, whether or not either of the other Re-authentication Options (Re-authentication, or Web-based Authentication) was selected. If the user believes he/she was incorrectly blocked from a specified site or service, he/she should re-start his/her machine and log back in.
- **Try re-authenticating your user profile** - This link displays if “Re-authentication” was selected at the Re-authentication Options field, and an entry was made in the Logon Script Path field. When the user clicks this link, a window opens:

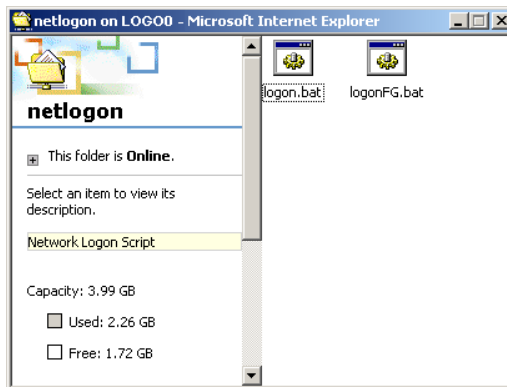

Fig. 2:1-7 Re-authentication option

The user should click the **logon.bat** icon to run a script that will re-authenticate his/her profile on the network.



NOTE: If the end user is using a non-IE browser type (i.e. Firefox, Safari, or Chrome) he/she will see a message specifying that IE is the only browser type supported for re-authentication.

ShutDown window

The ShutDown window displays when ShutDown is selected from the Control menu. This window is used for powering off the server.

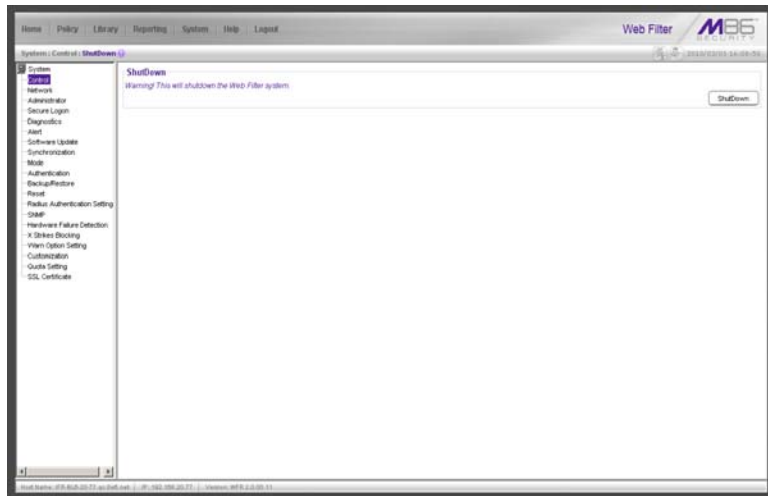

Fig. 2:1-8 ShutDown window

Shut Down the Server

In the ShutDown frame, click **ShutDown** to power off the server. To restart the server, the Web Filter console needs to be re-accessed.

Reboot window

The Reboot window displays when Reboot is selected from the Control menu. This window is used for reconnecting the server on the network.

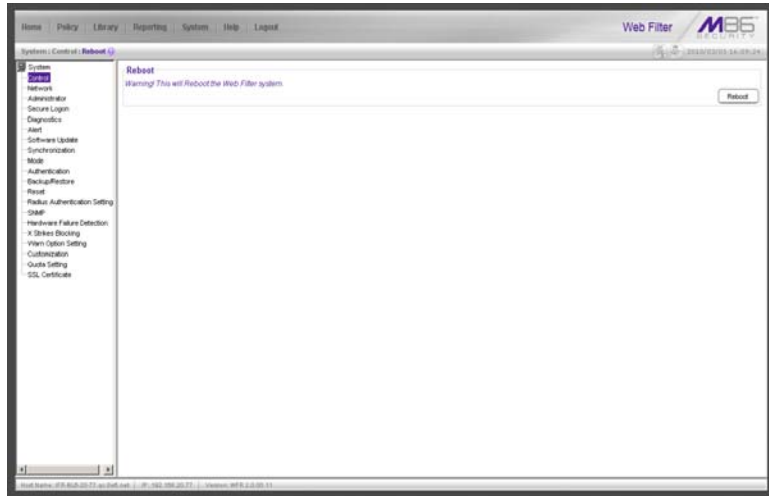

Fig. 2:1-9 Reboot window

Reboot the Server

1. In the Reboot frame, click **Reboot** to open the Reboot Web Filter dialog box.
2. Click **Yes** to close the dialog box and to launch the Server Status message box, informing you that the server is now disconnected.

When the Server Status box closes, the Web Filter status message box opens and informs you that the server is rebooting itself, and how much time has elapsed since this process began.

After the server is rebooted, the Web Filter status message box closes, and the Web Filter ready alert box opens.

The Server connected alert box also opens, informing you that the server is connected, and that you must restart the server.

3. Click **OK** to close the Web Filter ready alert box.
4. Click **OK** to close the Server connected alert box.
5. You must now re-access the Web Filter Administrator console.



NOTE: See Chapter 4: *Getting Started from the Introductory Section for information about accessing the Web Filter user interface and logging back into the server.*

Network

Network includes options for configuring the Web Filter on the network. Click the Network link to view a menu of sub-topics: LAN Settings, NTP Servers, Regional Setting, and Block Page Route Table.

LAN Settings window

The LAN Settings window displays when LAN Settings is selected from the Network menu. This window is used for configuring network connection settings for the Web Filter.

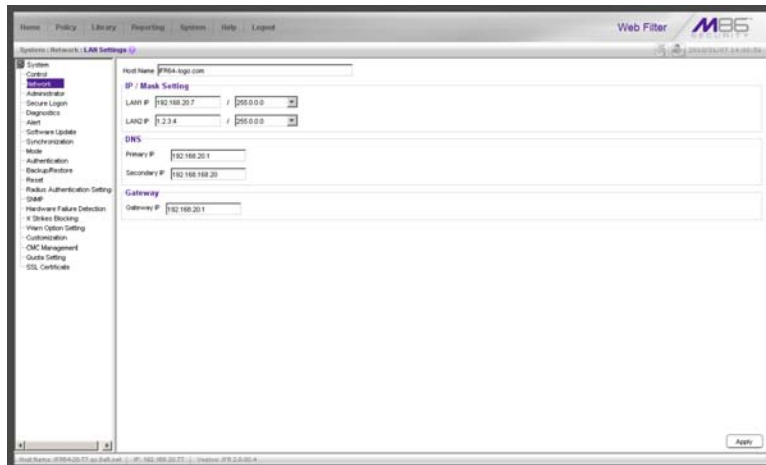

Fig. 2:1-10 LAN Settings window

Specify LAN Settings

1. In the **Host Name** field, enter up to 50 alphanumeric characters for the name of the host for this server, such as **wf.logo.com**.
2. Specify the following information, as necessary:
 - In the **LAN1 IP** field of the IP/Mask Setting frame, the default LAN 1 IP address is 1.2.3.3. Enter the IP address and select the corresponding subnet mask of the LAN1 network interface card to be used on the network.
 - In the **LAN2 IP** field, the default LAN 2 IP address is 1.2.3.4. Enter the IP address and select the corresponding subnet mask of the LAN2 network interface card to be used on the network.



TIP: Be sure to place the LAN1 and LAN2 IP addresses in different subnets.

- In the **Primary IP** field of the DNS frame, the default IP address is 4.2.2.1. Enter the IP address of the first DNS server to be used for resolving the IP address of the authentication server with the machine name of that server.
 - In the **Secondary IP** field of the DNS frame, the default IP address is 4.2.2.2. Enter the IP address of the second DNS server to be used for resolving the IP address of the authentication server with the machine name of that server.
 - In the **Gateway IP** field of the Gateway frame, the default IP address is 1.2.3.1. Enter the IP address of the default router to be used for the entire network segment.
3. Click **Apply** to apply your settings.



NOTE: Whenever modifications are made in this window, the server must be restarted in order for the changes to take effect.

NTP Servers window

The NTP Servers window displays when NTP Servers is selected from the Network menu. This window is used for specifying IP addresses of servers running Network Time Protocol (NTP) software. NTP is a time synchronization system for computer clocks throughout the Internet. The Web Filter will use the actual time from a clock at a specified IP address.



NOTE: The System Time displays beneath the Details frame, using the YYYY/MM/DD HH:MM:SS Coordinated Universal Time (UTC) format for the current time zone.

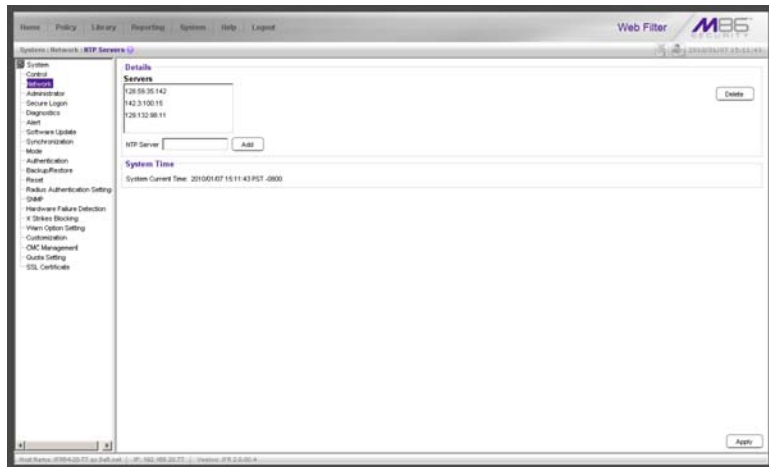

Fig. 2:1-11 NTP Servers window

Specify Network Time Protocol Servers

In the Details frame, three NTP server IP addresses display by default in the Servers list box. These IP addresses are: 128.59.35.142, 142.3.100.15, and 129.132.98.11.



NOTE: Any IP address following the first entry in the Servers list box is only used in the event that the Web Filter cannot access the primary time NTP server specified. IP addresses are used in the order in which they display in the list box.

Add an NTP Server

To add an NTP server:

1. Enter the IP address in the **NTP Server** field.
2. Click **Add** to include this IP address in the Servers list box.
3. Click **Apply** to apply your settings.

Remove an NTP Server

To remove an NTP server:

1. Select the IP address from the Servers list box.
2. Click **Delete**.
3. Click **Apply** to apply your settings.



WARNING: If using the Web Filter with the M86 Security Reporter or M86 Enterprise Reporter unit, be sure that device is connected to the same NTP servers as the Web Filter.

Regional Setting window

The Regional Setting window displays when Regional Setting is selected from the Network menu. This window is used for specifying the time zone to be used by the Web Filter and the language set type, if necessary.

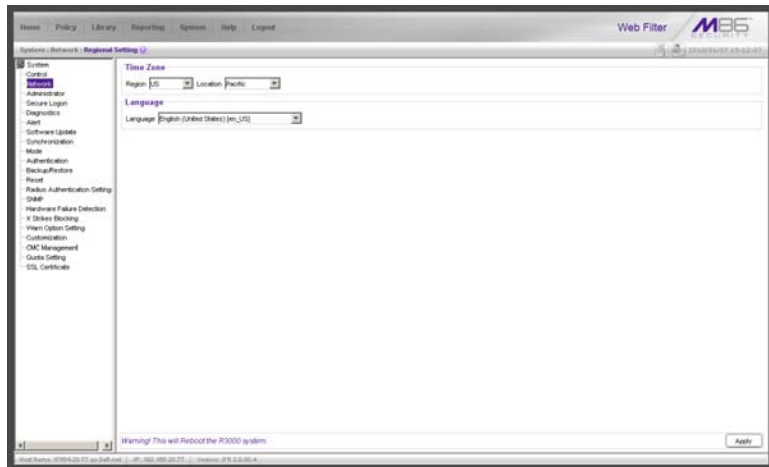

Fig. 2:1-12 Regional Setting window

Specify the Time Zone, Language Set

In the Details frame, the Region “US” and the Location “Pacific” display by default. To change these settings:

1. At the **Region** pull-down menu, select your country from the available choices.
2. At the **Location** pull-down menu, select the time zone for the specified region.

If necessary, select a language set from the **Language** pull-down menu to specify that you wish to display that text in the console.

3. Click **Apply** to apply your settings, and to reboot the Web Filter.



WARNING: If using the Web Filter with an M86 Security Reporter or M86 Enterprise Reporter unit, be sure each Web Filter used by the SR or ER is set up in the same time zone as the SR or ER. These “like” settings ensure consistency when tracking the logging times of all users on the network.

Block Page Route Table window

The Block Page Route Table window displays when Block Page Route Table is selected from the Network menu. This window is used for building and maintaining a list of destination based routers the server will use for communicating with other segments of the network. You need to set up a route table only if your local network is interconnected with another network, and if users' client machines are not being served block pages when appropriate.

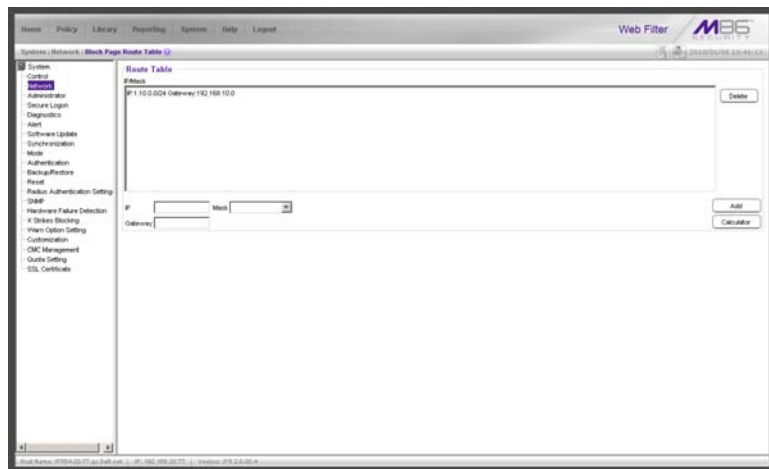

Fig. 2:1-13 Block Page Route Table window



NOTE: See the Block Page Authentication window for information on setting up block pages.

Add a Router

In the Route Table frame:

1. Enter the **IP** address.
2. Select the network subnet **Mask** from the pull-down menu.
3. In the **Gateway** field, enter the IP address of the portal to which packets will be transferred to and from the Internet.



TIP: Click **Calculator** to open the IP Calculator pop-up window. Use this calculator to calculate IP ranges without any overlaps.

4. Click **Add** to include your entries in the IP/Mask list box.



NOTE: Follow steps 1-4 for each router you wish to include in the routing table.

Remove a Router

To remove one or more routers from the IP/Mask list box:

1. Select the router(s) from the list box.
2. Click **Delete**.

Administrator

Administrator window

The Administrator window displays when Administrator is selected from the navigation panel. This window is used for adding and maintaining global administrator (Admin), group administrator (Sub Admin), and help desk administrator (Help Desk) accounts. A Sub Admin manages LDAP entities and their filtering profiles. A Help Desk administrator can verify a user's current filtering profile status and can perform URL and search engine keyword lookups in library categories.



NOTE: See the Group Details window in Chapter 1: Policy screen of the Group Administrator Section for information on setting up and maintaining accounts for IP group administrators. See the M86 Web Filter Authentication User Guide for more information on setting up and maintaining LDAP Sub Admin group administrator accounts. A help desk administrator will only see his/her account information and can only modify his/her password.

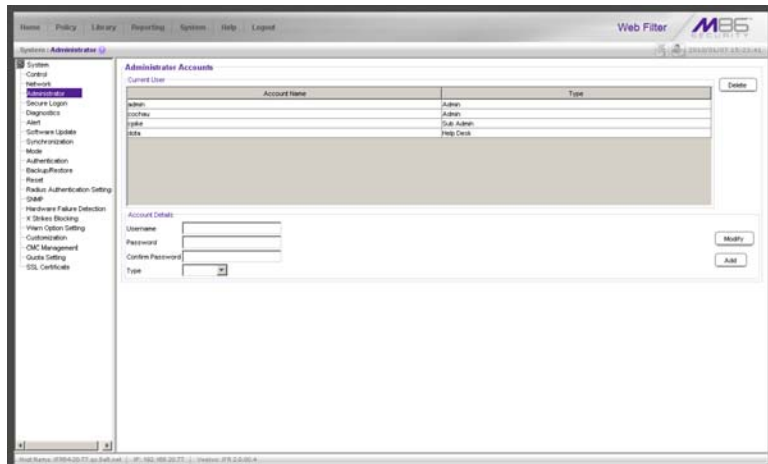

Fig. 2:1-14 Administrator window



TIP: The default Username is **admin** and the Password is **user3**. M86 recommends that you retain this default account and password in the event that the Web Filter cannot be accessed. An authorized M86 Security technical representative may need to use this username and password when troubleshooting the unit.



WARNING: Always be sure that at least one account is listed in this window at all times.

View Administrator Accounts

The Current User list box includes the Account Name and corresponding account Type (“Admin”, “Sub Admin”, or “Help Desk”) for each active global administrator, LDAP group administrator, or help desk administrator previously set up in this window.

Add an Administrator Account

To add an administrator account:

1. In the Account Details frame, enter the username in the **Username** field.
2. In the **Password** field, enter eight to 20 characters—including at least one alpha character, one numeric character, and one special character. The password is case sensitive.
3. Make the same entry again in the **Confirm Password** field.
4. Select “Admin”, “Sub Admin”, or “Help Desk” from the **Type** pull-down menu.
5. Click **Add** to include the username and account type in the Current User list box.

Edit an Administrator Account

To change an administrator's password and/or account type:

1. Select the username from the Current User list box; this action populates the Account Details frame with data.
2. In the **Password** field, enter eight to 20 characters for a new password—including at least one alpha character, one numeric character, and one special character. The password is case sensitive.
3. Enter the same new password again in the **Confirm Password** field.

If the administrator's account type needs to be changed, select the appropriate account type from the **Type** pull-down menu ("Admin" for global administrator, "Sub Admin" for LDAP group administrator, or "Help Desk" for help desk administrator).

4. Click **Modify** to apply your settings.



NOTE: A username cannot be modified, but can be deleted and added again.

Delete an Administrator Account

To delete an administrator account:

1. Select the username from the Current User list box.
2. Click **Delete** to remove the account.

Secure Logon

Secure Logon includes options for setting user passwords to expire after a designated number of days, and/or locking out users from the Web Filter after unsuccessfully attempting to log in for the specified number of attempts within the defined timespan. Click the Secure Logon link to view a menu of sub-topics: Logon Settings, and Logon Management.

Logon Settings window

The Logon Settings window displays when Logon Settings is selected from the Secure Logon menu. This window is used for enabling the password expiration feature in which you define the number of days a password will be valid before a new password must be used. You can also enable the feature for locking out a user from the interface by user-name and/or IP address if an incorrect password is entered for a specified number of times within a defined timespan.



NOTE: This window displays only on servers set up in the Stand-alone or Source mode.

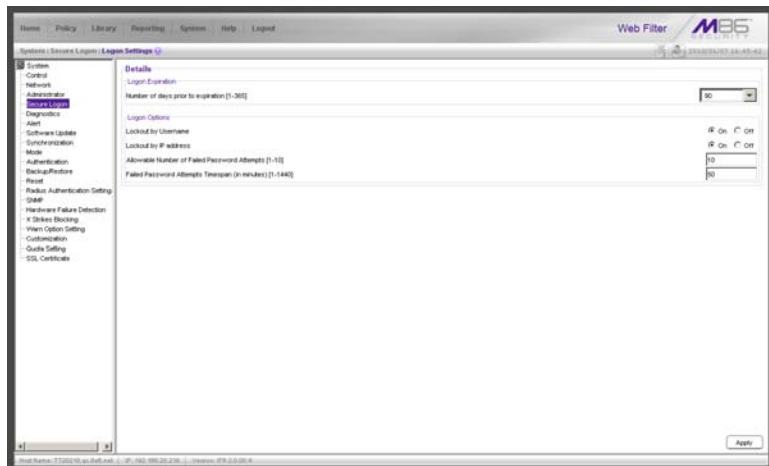

Fig. 2:1-15 Logon Settings window

Enable, Disable Password Expiration

In the Logon Expiration frame, at the **Number of days prior to expiration [1-365]** field, specify the number of days logon passwords will be effective by doing one of the following:

- select from available choices (1, 30, 90, 365, Never Expired)
- make an entry for the number of days until passwords expire.



NOTE: *If a user's password has expired, when he/she enters his/her username and password in the Login window and clicks LOGIN, a login dialog box opens:*

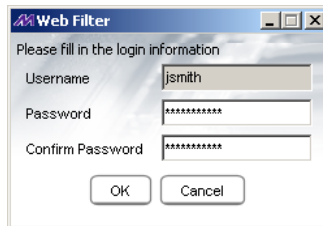

Fig. 2:1-16 New password entry

This dialog box displays his/her Username and prompts him/her to enter a new password in the Password and Confirm Password fields. Upon clicking OK, the Web Filter user interface opens.

Enable, Disable Account Lockout

1. In the Logon Options frame, enable any of the following options:
 - At the **Lockout by Username** field, click the radio button corresponding to either of the following options:
 - **On** - Choose this option to lock out the user by username if the incorrect password is entered—for the number of times specified in the Allowable Number of Failed Password Attempts [1-10] field—within the interval defined in the Failed Password Attempts Timespan (in minutes) [1-1440] field.
 - **Off** - Choose this option if the user will not be locked out by username after entering the incorrect password.
 - At the **Lockout by IP address** field, click the radio button corresponding to either of the following options:
 - **On** - Choose this option to lock out the user by IP address if the incorrect password is entered—for the number of times specified in the Allowable Number of Failed Password Attempts [1-10] field—within the interval defined in the Failed Password Attempts Timespan (in minutes) [1-1440] field.
 - **Off** - Choose this option if the user will not be locked out by IP address after entering the incorrect password.
 - At the **Allowable Number of Failed Password Attempts [1-10]** field—with the Lockout by Username and/or Lockout by IP address option(s) enabled—enter the number of times a user can enter an incorrect password during the interval defined in the Failed Password Attempts Timespan (in minutes) [1-1440] field before being locked out of the Web Filter.

- At the **Failed Password Attempts Timespan (in minutes) [1-1440]** field—with the Lockout by Username and/or Lockout by IP address option(s) enabled—enter the number of minutes that defines the interval in which a user can enter an incorrect password—as specified in the Allowable Number of Failed Password Attempts [1-10] field—before being locked out of the Web Filter.



NOTE: *If the number of failed attempts is 3 and the number of minutes in the timespan is 10, if any user (one or more) enters an incorrect password for that same username within the 10-minute timespan, a lockout would be made for that username on the third unsuccessful attempt. However, if the third failed login attempt is made outside of the 10-minute timespan, there would be no lockout for that username. In a similar scenario for an IP address (using the same timespan and designated number of failed login attempts), if any user (one or more) enters an incorrect password for any username (one or more) using that same machine, a lockout would be made for that machine's IP address on the third unsuccessful login attempt. But there would be no lockout for that IP address if the third failed attempt was made outside of the 10-minute timespan.*

2. Click **Apply** to apply your settings.

Logon Management

The Logon Management window displays when Logon Management is selected from the Secure Logon menu. This window is used for viewing the status of user accounts—including the date passwords will expire, and which usernames/IP addresses are currently locked out of the Web Filter user interface—and for unlocking usernames and IPs currently locked out of the Web Filter. If the user account is a global (Admin), LDAP group administrator (Sub Admin), or help desk administrator (Help Desk) account, the areas of user interface accessible to that administrator can be viewed.

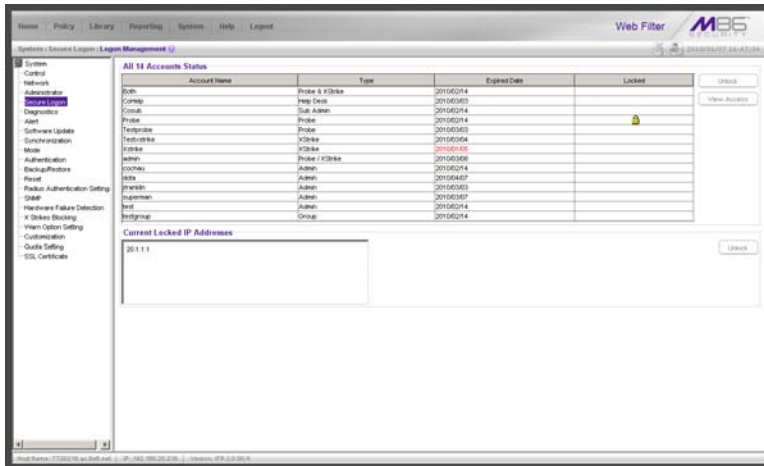



Fig. 2:1-17 Logon Management window

 **NOTE:** An account/IP address becomes locked if the Lockout by Username/IP address feature is enabled in the Logon Settings window, and a user is unable to log into the Administrator console due to a password expiration, or having met the specified number of failed password attempts within the designated timespan.

View User Account Status, Unlock Username

View Account Status

The All Accounts Status frame displays password statuses of current login accounts set up in this Web Filter being configured, including:

- Account Name - username
- Type of account:
 - Admin - global administrator account set up in the Administrator window
 - Sub Admin - LDAP group administrator account set up in the Administrator window
 - Help Desk - help desk administrator account set up in the Administrator window
 - Group - IP group administrator account set up in the IP branch of the Policy tree
 - Probe - Real Time Probe account set up in the Real Time Probes Logon Accounts window
 - XStrike - X Strikes Blocking account set up in the X Strikes Blocking Logon Accounts window
- Expired Date (either Never Expired or a date using the YYYY-MM-DD format, based on the configuration in the Logon Settings window at the time the password was saved in that window)
- lock symbol if the account is currently locked.



TIP: This list can be resorted by clicking a specified column header.

Unlock a Username

To unlock a username:

1. Select the Account Name from the All Accounts Status frame by clicking on it to highlight it.
2. Click **Unlock** to open the dialog box asking if you wish to proceed with this action.



TIP: Click No to close the dialog box.

3. Click **Yes** to display the alert box indicating the account was unlocked.
4. Click **OK** to close the alert box, and to remove the locked symbol from the Locked column for the row corresponding to the username.

View Locked IP Address, Unlock IP Address

View Locked IPs

The Current Locked IP Addresses frame displays any IP address currently locked.

Unlock an IP Address

To unlock the IP address of a machine:

1. In the Current Locked IP Addresses frame, click the IP address to highlight it.
2. Click **Unlock** to open the dialog box, asking if you wish to unlock the IP address.



TIP: Click No to close the dialog box.

3. Click **Yes** to display the alert box indicating the IP address was unlocked.
4. Click **OK** to close the alert box, and to remove the IP address from the list.

View Admin, Sub Admin User Interface Access

To view the areas of the user interface accessible by a global administrator, LDAP group administrator, or help desk administrator:

1. Select the Admin, Sub Admin, or Help Desk username from the list.
2. Click **View Access** to open the Assign Access View pop-up window:



Fig. 2:1-18 Assign Access View

3. The View/Preview assign access frame displays the username in the greyed-out “Assign to user” field.
Click any of the available tabs (System, Policy, Library, Report, Help) to view menu topics, sub-topics, and branches of trees available to that administrator.
4. Click the “X” in the upper right corner of the window to close it.

Diagnostics

Diagnostics includes options for setting up or running processes for maintaining the server. Click the Diagnostics link to view a menu of sub-topics: System Command, View Log File, Troubleshooting Mode, Active Profile Lookup, and Admin Audit Trail.

System Command window

The System Command window displays when System Command is selected from the Diagnostics menu. This window is used for viewing server statistics and for performing diagnostic tests on the server.

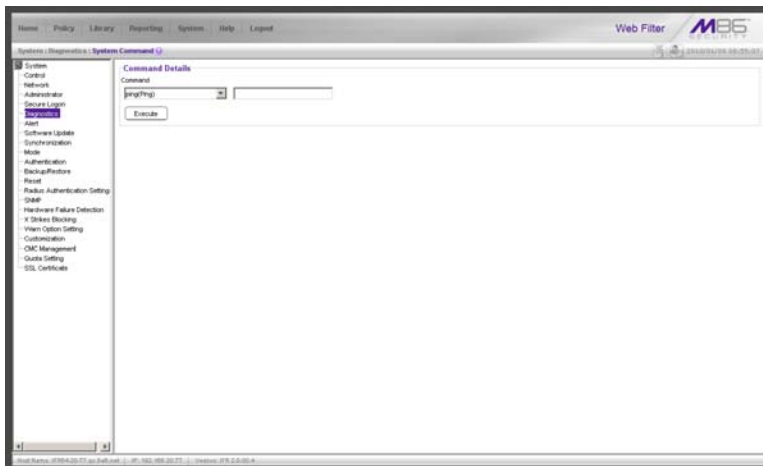

Fig. 2:1-19 System Command window



WARNING: Diagnostics tools utilize system resources, impacting the Web Filter's performance.

Perform a Diagnostic Test, View Data

1. Select a diagnostic tool from the **Command** pull-down menu: ping(Ping), traceroute(Trace Route), ps(Process list), top(TOP CPU processes), ifconfig(NIC configuration), netstat(active connections), netstat(routing table), free(current memory usage), iostat(CPU usage), sar(system performance), recent logins, uptime(system uptime), df(disk usage), and dmesg(print kernel ring buffer).



NOTE: See *Command Selections* for a list of commands and their functions.

If “Ping” or “Trace Route” was selected from the pull-down menu, a blank field displays to the right and must be populated.

2. Click **Execute** to open a pop-up window containing the query results:

```

M86 Web Filter
Web Filter M86 SECURITY

Result

Ping 192.168.20.170 (192.168.20.170) 56(84) bytes of data:
64 bytes from 192.168.20.170: icmp_seq=1 ttl=64 time=1.00 ms
64 bytes from 192.168.20.170: icmp_seq=2 ttl=64 time=0.581 ms
64 bytes from 192.168.20.170: icmp_seq=3 ttl=64 time=1.38 ms
64 bytes from 192.168.20.170: icmp_seq=4 ttl=64 time=1.41 ms
64 bytes from 192.168.20.170: icmp_seq=5 ttl=64 time=0.984 ms

--- 192.168.20.170 ping statistics ---
5 packets transmitted, 5 received, 0% packet loss, time 4003ms
rtt min/avg/max/mdev = 0.981/21.086/100.672/59.793 ms
  
```

Fig. 2:1-20 System Command, Results window

3. Click the “X” in the upper right corner of the pop-up window to close it.

Command Selections

Ping

The Ping diagnostic tool is used for verifying whether the Web Filter can communicate with a machine at a given IP address within the network, and the speed of the network connection. Enter the IP address or host name of the specific Internet address to be contacted (pinged), and then click **Execute** to display results in the pop-up window.

Trace Route

The Trace Route diagnostic tool should be used if the ping utility was not able to help you diagnose the problem with your network configuration. This diagnostic tool records each hop the data packet made, identifying the IP addresses of gateway computers where the packet stopped en route to its final destination, and the length of time of each hop. Enter the IP address or host name of the specific Internet address to be validated, and then click **Execute** to display results in the pop-up window.

Process list

The Process list diagnostic tool is used for viewing a list of processes that have run on the server, and their statuses. When **Execute** is clicked, rows of processes display in the pop-up window, including the following information for each process: Process Identification Number, full device number of the controlling terminal, status code, amount of time it took to run the process, and command line.

TOP CPU processes

The TOP CPU processes diagnostic tool is used for analyzing how much memory and CPU power is being consumed by which processes. When **Execute** is clicked, the pop-up window displays the following information: the load average, number of processes that can run, current utilization by CPUs on the system, and memory and swap file space currently being used and currently available. A row of statistics displays for each process utilizing the most resources on the system.

NIC configuration

NIC Configuration is used for verifying the server's network interface configuration at bootup. When **Execute** is clicked, information about the NIC mode and RX packets and TX packets displays in the pop-up window.

Active connections

When Active Connections is selected and **Execute** is clicked, information about opened connections displays in the pop-up window. The first half of the results includes packet traffic data on configured network interfaces. The second half of the results includes a list of active UNIX domain sockets for each protocol.

Routing table

When Routing Table is selected and **Execute** is clicked, information about available routes and their statuses displays in the pop-up window. Each route consists of a destination host or network and a gateway to use in forwarding packets.

Current memory usage

When Current Memory Usage is selected and **Execute** is clicked, the pop-up window shows the amount of memory being used, and the amount of memory available for three intervals of one second each.

CPU usage

The CPU Usage diagnostic tool shows information on disk usage. When **Execute** is clicked, the pop-up window shows the average CPU usage, as well as the usage by device and file system/partition.

System performance

The System Performance diagnostic tool shows information on resources being used. When **Execute** is clicked, the pop-up window shows averages on various statistics. These results can be stored in a compact binary format and then viewed at later date, so that if you discover a system or application problem occurred, you can analyze system activity during that time period. With this data, you can specify start and end times for reporting on that data, and calculate average usage for periods of time when performance is most critical or during normal user hours.

Recent logins

The Recent Logins diagnostic tool is used for showing information on administrator login activity. When **Execute** is clicked, the pop-up window displays a row of data for each time an administrator logged on the Web Filter.

System uptime

The System uptime diagnostic tool is used for showing the amount of time the Web Filter has been "up" and running. When **Execute** is clicked, the pop-up window displays a row of data showing the current time, the amount of time the Web Filter has been up, the number of users, and the load averages for the past 1, 5 and 15 minute intervals.

df(disk usage)

The Disk Usage diagnostic tool is used for viewing disk usage information by file system. When **Execute** is clicked, rows of disk information display in the Result pop-up window, including the following information for each disk: Filesystem name, 1K-blocks on the disk, number of Used blocks, number of Available blocks, Use%, locations where the disk is Mounted on.

dmesg(print kernel ring buffer)

The Print Kernel Ring Buffer diagnostic tool is used for viewing the kernel ring buffer in which kernel messages are stored. When **Execute** is clicked, messages from the kernel ring buffer display in the Result pop-up window. These messages from system boot-up provide information about hardware and module initialization, useful for diagnosing system problems.

View Log File window

The View Log File window displays when View Log File is selected from the Diagnostics menu. This window is used for viewing the most recent log file results of various activities and for troubleshooting.

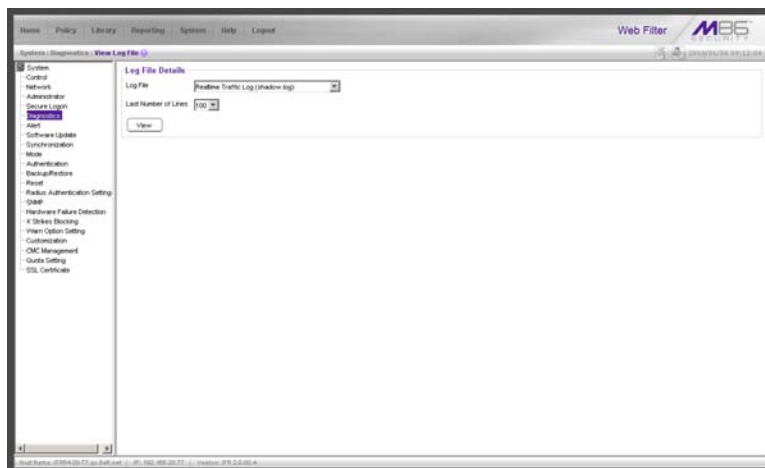

Fig. 2:1-21 View Log File window

View Log Results

In the Log File Details frame:

1. Select the type of **Log File** to view:
 - “Realtime Traffic Log (shadow.log)” - used for viewing the Internet activity of all users on the network.
 - “User Name Log (usage.log)” - used for viewing the time and date a user logged on and off the network, along with the user's profile information.
 - “Software Update Log (patch.log)” - used for viewing the results of a software update application, such as which files were copied to the server, and whether the software update was successfully applied.

- “Error Log (error.log)” - used only if an Alternate IP Address is being used in the Block Page Route frame of the Operation Mode window. This log only displays information if the IP address used for sending block pages is not being reconciled with the MAC address of the NIC card.
- “Admin GUI Server Log (AdminGUIserver.log)” - used for viewing information on entries made by the administrator in the Web Filter console.



NOTE: For information about the “Authentication Log (AuthenticationServer.log)”, “eDirectory Agent Debug Log (edirAgent.log)”, “eDirectory Agent Event Log (edirEvent.log)” and “Authentication Module Log (authmodule.log)” options, see the View log results section in the M86 Web Filter Authentication User Guide.

2. Choose the **Last Number of Lines** to view (100-500) from that file.
3. Click **View** to to open a pop-up window containing the log results:

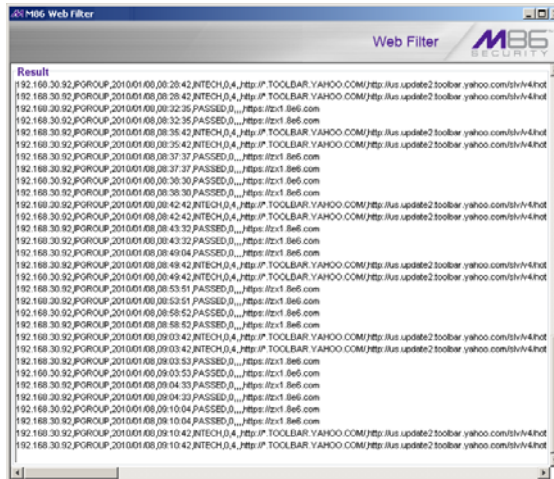

Fig. 2:1-22 View Log File, Results window

4. Click the “X” in the upper right corner of the pop-up window to close it.

Troubleshooting Mode window

The Troubleshooting Mode window displays when Troubleshooting is selected from the Diagnostics menu. This window is used if the server is not sending or receiving packets as normal.

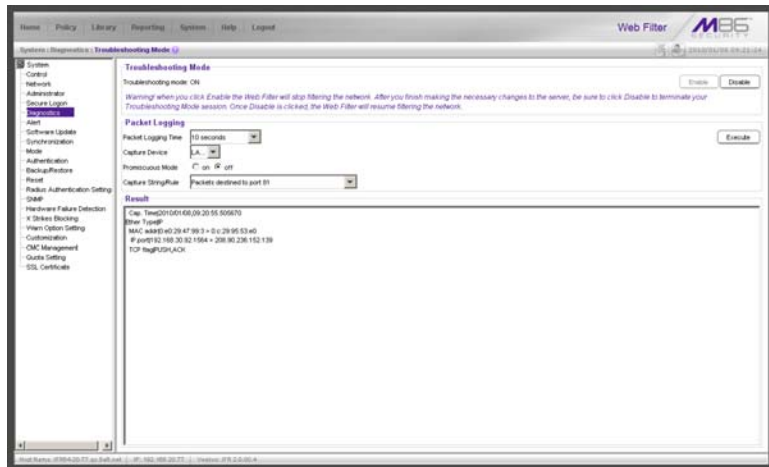



Fig. 2:1-23 Troubleshooting Mode window

 **WARNING:** This tool utilizes system resources, impacting the Web Filter's performance. When you click Enable, the Web Filter will stop filtering the network. After you finish making the necessary changes to the server, be sure to click Disable to terminate your Troubleshooting Mode session. Once Disable is clicked, the Web Filter will resume filtering the network.

 **NOTE:** See the Operation Mode window for information about invisible, router, and firewall modes, and listening devices.

Use the Troubleshooting Mode

1. Click **Enable** to begin working in the troubleshooting mode.
2. In the Packet Logging frame, select the **Packet Logging Time** from the available selections (10 seconds, 30 seconds, 60 seconds). This time is the interval during which the server captures packets in real time, ranging from the moment the command is executed until the designated point of time in the future.
3. At the **Capture Device** field, the default listening device for the operation mode displays. If necessary, make a selection from the pull-down menu that corresponds to the operation mode used on the network—"LAN2" or "LAN1".
4. At the **Promiscuous Mode** field, the default choice ("on" or "off") displays, based on the operation mode that was selected. The promiscuous mode is a mode of operation in which each data packet that is sent will be received and read by the Network Interface Card (NIC).
5. If necessary, click the appropriate radio button to indicate whether to turn the promiscuous mode on or off. If "on" is selected, the Web Filter will watch all network traffic as in the invisible mode. If "off" is selected, the Web Filter will only capture packets sent to or from the Web Filter.
6. At the **Capture String/Rule** field, select the type of packets to be captured: Transmission Control Protocol (TCP); packets destined to a specified port (80, 443, 81); packets destined to the Web Filter; packets sent to or from port 20 or 21; packets sent to the Virtual IP address's port 137 or 139, or Address Resolution Protocol (ARP).
7. Click **Execute** to display results in the Result list box.

- After performing the fixes on the Web Filter, return to this window and click **Disable** to resume filtering the network.

Active Profile Lookup window

The Active Profile Lookup window displays when Active Profile Lookup is selected from the Diagnostics menu. This window is used for verifying whether an entity has an active filtering profile. This window also is used for troubleshooting synchronization on "target" Web Filters, to verify whether settings for user profiles match the ones synced over from the "source" Web Filter.



Fig. 2:1-24 Active Profile Lookup window



NOTE: In order to use this diagnostic tool, IP groups and/or members must be set up in the Policy section of the Web Filter, and each IP group and/or member must have a filtering profile. MAC addresses are used in the mobile mode only.

Verify Whether a Profile is Active

1. In the **User IP/MAC Address** field, enter the IP address or MAC address of the end user.
2. Click **Lookup** to verify whether or not a profile is active for that IP/MAC address.

If the filtering profile is active, a pop-up box opens containing the Result frame that displays profile settings applied to the profile:

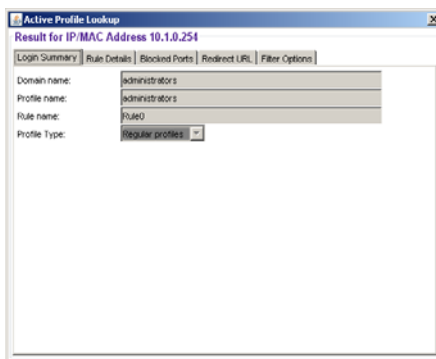

Fig. 2:1-25 Active Profile Lookup results

The default Login Summary tab displays the following information:

- **Domain name** - IP group domain name
- **Profile name** - name of the profile
- additional profile information:
 - **Time profile name** - for time profiles, the name of the time profile displays
 - **Rule name** - if this profile uses a non-custom rule, the rule number displays
- **Profile Type** - type of profile, greyed-out:
 - Regular profiles - IP group, sub-group, individual, or MAC profile

- Global profile - Global Group Profile
- Override profiles - Override Account profile
- Lock profiles - X Strikes Blocking lock out profile
- Time profiles - Time Profile
- TAR profile - Threat Analysis Reporter lock out profile
- Radius profile - Radius accounting server profile



NOTE: See the *M86 Web Filter Authentication User Guide* for information that displays in these fields if the domain is an LDAP domain.

3. Click the following tabs to view information in that tab: Rule Details, Blocked Ports, Redirect URL, Filter Options.

- **Rule Details** - In the Rule Details frame, the Category Groups tree displays group and library categories with filter settings that determine whether or not the end user can access URLs set up for that category group/library category.



TIP: In the Category Groups tree, double-click the group envelope to open that segment of the tree and to view library categories belonging to that group.

A check mark inside a green circle displays in the Pass, Allow, Warn, Block column for the filter setting assigned to the category group/library category for the end user. These filter settings indicate the following:

- Pass - URLs in this category will pass to the end user.
- Allow - URLs in this category will be added to the end user's white list.
- Warn - URLs in this category will warn the end user that the URL he/she requested can be accessed, but may be against the organization's policies. The end user can view the URL after seeing a warning

message and agreeing to its terms.

- **Block** - URLs in this category will be blocked.
- **Quota** - If a number displays in this column, the corresponding category group/library category was set up as passed but with a time limit, as defined by the number of minutes in that column. After spending 75 percent of the allotted time visiting URLs in that group/category, the user receives a quota warning message; after spending 100 percent of the allotted time visiting URLs in that group/category, he/she receives a quota block page.



NOTE: *If a category group does not display any filter setting (i.e. the check mark does not display in any column for the category group), one or more library categories within that group has a filter setting in a column other than the filter setting designated for all collective library categories within that group. For example, if in the Adult Content category group some of the library categories have a block setting and other library categories have a warn setting, there would be no category group filter setting, since all library categories do not have the same filter setting.*

At the bottom of the Rule Details frame, Uncategorized Sites are set to “Pass”, “Warn”, or “Block”, indicating that the selected setting applies to any non-classified URL. If the Overall Quota field is enabled, the user is restricted to the number of minutes shown here for visiting URLs in all groups/categories collectively in which a quota is specified.

- **Blocked Ports** (optional) - ports that have been set up to be blocked, if established.
- **Redirect URL** (optional) - the URL that will be used for redirecting the user away from a page that is blocked, if established.

- **Filter Options** (optional) - filter options to be used in the user’s profile: “X Strikes Blocking”, “Google/Bing/Yahoo!/Youtube/Ask/AOL Safe Search Enforcement”, “Search Engine Keyword Filter Control”, and/or “URL Keyword Filter Control” with/without the “Extend URL Keyword Filter Control” option selected.
4. Click the “X” in the upper right corner of the pop-up box to close it.

Admin Audit Trail window

The Admin Audit Trail window displays when Admin Audit Trail is selected from the Diagnostics menu. This window is used for specifying FTP criteria so that a log of server changes made by an administrator will be sent to the FTP server. The log of changes made on the server can be viewed in this window.

Admin Audit Trail

The Admin Audit Trail tab displays by default:

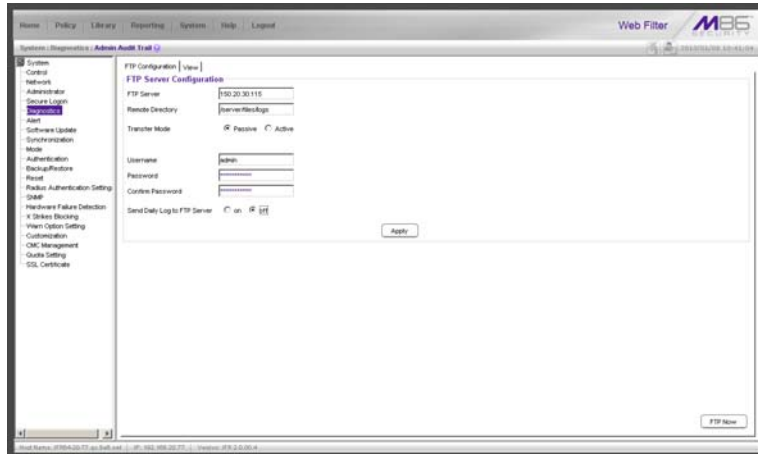

Fig. 2:1-26 Admin Audit Trail window

Specify FTP Criteria

1. Enter the IP address of the **FTP Server**.
2. The log will be sent to the current default directory, unless a **Remote Directory** is specified.
3. At the **Transfer Mode** field, "Passive" is selected by default, indicating that transfers will be made via unrestricted outgoing network connections. Click "Active" if transfers will be initiated by the server.
4. Type in the **Username** to be used.
5. Type in the **Password** to be used, and type it again in the **Confirm Password** field.
6. Specify whether or not to **Send Daily Log to FTP Server** by clicking either the "on" or "off" radio button.
7. Click **Apply** to apply your settings.

FTP the Log on Demand

Click **FTP Now** to transfer the log on demand.

View

View the Log of Administrator Changes

To view the log, click the View tab:

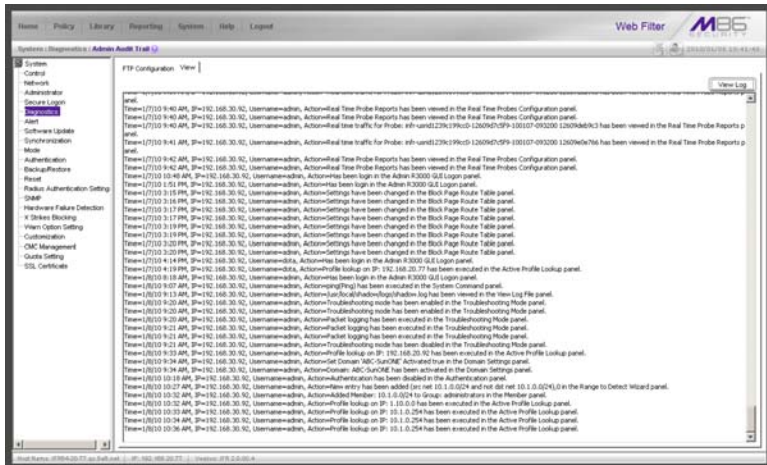

Fig. 2:1-27 Admin Audit Trail window, View tab

Click **View Log** to display data on recent activity. For each change made to the server, the log will contain the date and time the change was made (Time), IP address of the machine used by the administrator, administrator's User-name, and a brief description of the Action performed on the server.

Alert

Alert includes options for setting up alert emails that notify designated individuals of problems on the network. Click the Alert link to view a menu of sub-topics: Alert Settings, and SMTP Server Settings.

Alert Settings window

The Alert Settings window displays when Alert Settings is selected from the Alert menu. This window is used for setting up and maintaining email addresses of contacts who will receive automated notifications if problems on the network are detected during the Web Filter's self-monitoring process.

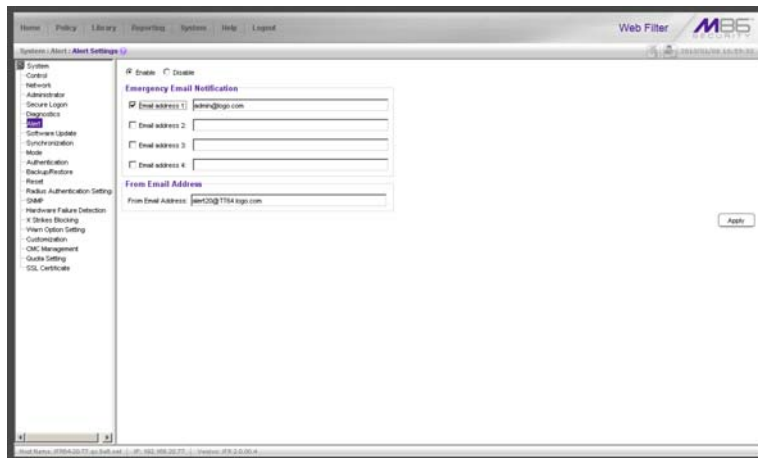

Fig. 2:1-28 Alert Settings window

The following processes are monitored by the Web Filter:

- **CPU Processes** - If any CPU process fails to run, the Web Filter alerts the administrator about the failed process, and that an attempt will be made to reload the necessary process. The last few lines of any pertinent logs are included in the message to assist the adminis-

trator in troubleshooting the problem. In most cases, the reload procedure will fix the error, and no further intervention will be required. However, if the error is not fixed—such as if a misconfiguration was made that causes a process to be unable to load on the system—the Web Filter repeats this procedure until an administrator fixes the error.

- **Hard Drive Utilization** - If the Web Filter detects that hard drive utilization exceeds 80 percent, an alert is sent to the administrator. This problem usually occurs if the Web Filter is unable to transfer log files to the reporting application—an M86 Enterprise Reporter (ER) server, or a designated third party FTP server. Action should be taken to prevent the hard drive from reaching 100 percent utilization.
- **Log File Transmission** - If the Web Filter is unable to send log files as scheduled to an ER server or a third party FTP server, the log files are placed in a queue so they can be sent when a connection is established with the server. If these logs cannot be successfully transmitted after a period of time, an alert is sent to the administrator. The last few lines of the error log are included in the message to assist the administrator in troubleshooting the problem.
- **Synchronization Errors** - If the synchronization feature is used, an alert is sent to the administrator if a Web Filter set up in the Source mode cannot communicate with the target server(s) after numerous attempts, or if a Web Filter set up in the Target mode cannot communicate with the source server. The last few lines of the error log are included in the message to assist the administrator in troubleshooting the problem.

Enable the Alert Feature

By default, the “Disable” radio button is selected. To enable the feature for sending automated email notifications:

1. Click the “Enable” radio button to activate all elements in the Emergency Email Notification frame.
2. Enter up to four email addresses of contacts.
3. Click in the checkbox of each email address that should receive notifications regarding network problems.
4. If using an SMTP server for sending alert email messages to designated administrators, enter the email address of the Web Filter in the **From Email Address** field.
5. Click **Apply** to apply your settings.

Modify Alert Settings

1. Make any of the following edits in the Emergency Email Notification frame:
 - change an email address by typing the new one over the existing one
 - deactivate a contact by removing the check mark from the checkbox corresponding to that contact’s email address
 - delete a contact by using your mouse to copy over the entire email address, and then pressing the Delete key on your keyboard
2. After all edits have been made, click **Apply** to apply your settings.

Disable the Alert Feature

1. Click the “Disable” radio button.
2. Click **Apply** to apply your settings.

SMTP Server Settings window

The SMTP Server Settings window displays when SMTP Server Settings is selected from the Alert menu. This window is used for entering settings for the Simple Mail Transfer Protocol that will be used for sending email alert messages to specified administrators.

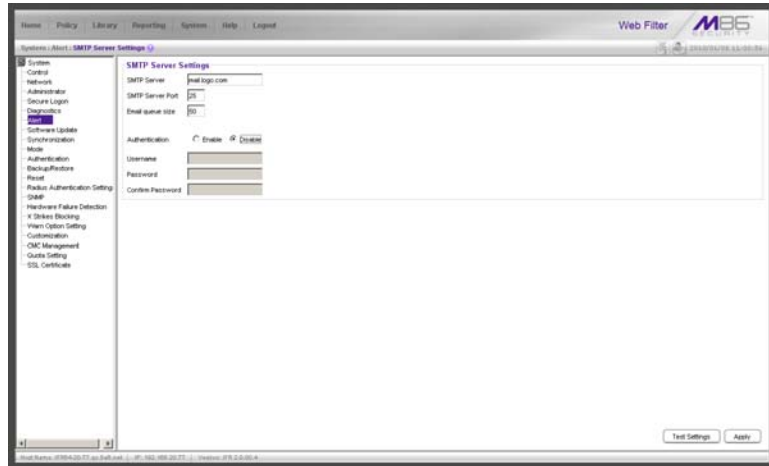

Fig. 2:1-29 SMTP Server Settings window

Enter, Edit SMTP Server Settings

1. Enter the **SMTP Server** name, for example: **mail.logo.com**.
2. By default, the **SMTP Server Port** number used for sending email is 25. This should be changed if the sending mail connection fails.
3. By default, the **Email queue size** is 50. This can be changed to specify the maximum number of requests that can be placed into the queue awaiting an available outbound connection.

- By default, **Authentication** is disabled. Click “Enable” if a username and password are required for logging into the SMTP server. This action activates the fields below.

Make the following entries:

- Enter the **Username**.
 - Enter the **Password** and make the same entry in the **Confirm Password** field.
- Click **Apply** to apply your settings.

Verify SMTP Settings

To verify that email messages can be sent to a specified address:

- Click **Test Settings** to open the pop-up box:

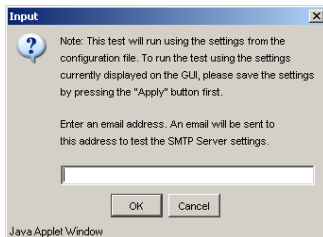

Fig. 2:1-30 SMTP Test Settings box

- Enter the email address in the pop-up box.
- Click **OK** to close the pop-up box and to process your request. If all SMTP Server Settings are accepted, the test email should be received at the specified address.

Software Update

Software Update includes options for uploading software updates. Click the Software Update link to view a menu of sub-topics: Local Software Update, and Software Update Log.

Local Software Update window

The Local Software Update window displays when Local Software Update is selected from the Software Update menu. This window is used for viewing information about software updates previously applied to this server or currently available to apply. This screen is also used for accepting LA/Beta software downloads, if choosing to download Limited Availability (LA) and/or Beta updates for previewing software features to be included in the General Availability (GA) release to be distributed to all Web Filters.

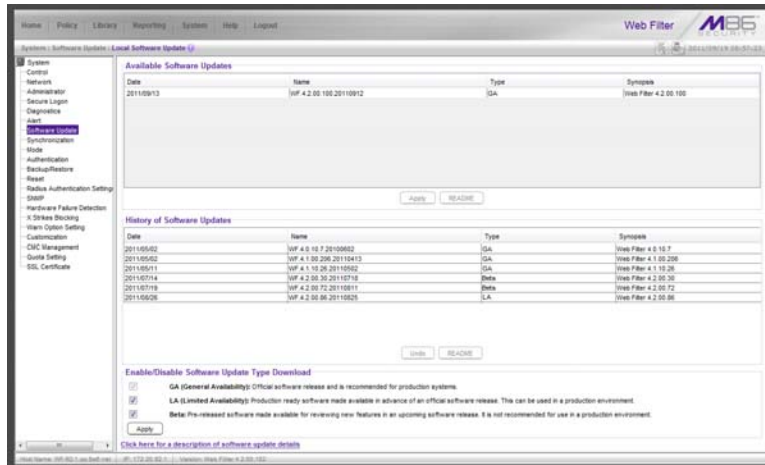

Fig. 2:1-31 Local Software Update window



NOTE: Available software updates for the Web Filter come from downloads made to the server via Traveler, M86’s executable program that can run on demand, or be set to run at a scheduled time.



TIP: Click the link (“here”) at the bottom of the window to go to the Web page at M86 Security’s public site (<http://www.m86security.com/support/r3000/documentation.asp>) where release notes about software updates can be obtained.

Read Information about a Software Update

In either the Available Software Updates frame or the History of Software Updates frame, the Date, Name, Type of update (GA, LA, or Beta), and Synopsis are included for each software update.

To read information about a software update:

1. Select a software update from the list.
2. Click the **README** button to open the README pop-up box that contains information about the software update:

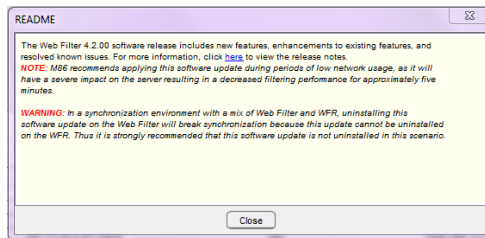

Fig. 2:1-32 Software update readme

3. Click **Close** to close the pop-up box.

Select and Apply a Software Update



NOTES: Software updates must be applied to the server in sequential order. Be sure port 8082 is open on your network.

General Software Installation Procedures

These instructions pertain to the installation of GA software updates, or LA/Beta software updates—if the download and installation of LA/Beta software updates has been enabled in the Enable/Disable Software Update Type Download frame (see the Enable/Disable Software Update Type Downloads sub-section).

To apply a software update:

1. Go to the Available Software Updates frame and select the software update to be applied.
2. Click **Apply** to open the software update installation dialog box:

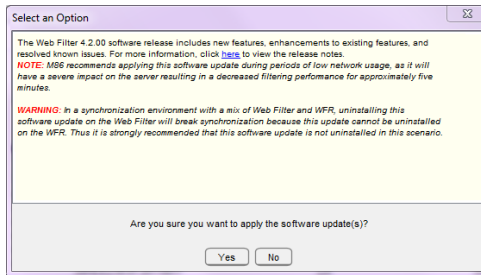

Fig. 2:1-33 Software update installation dialog box

3. Click **Yes** to open the EULA dialog box:



Fig. 2:1-34 EULA dialog box

- After reading the contents of the End User License Agreement, click **Yes** if you agree to its terms. This action closes the EULA dialog box and opens the alert box verifying the software update application process:

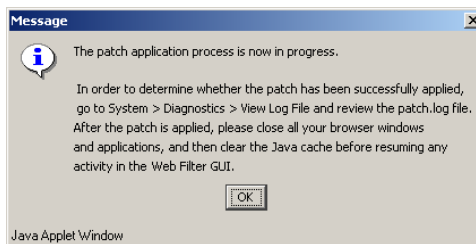

Fig. 2:1-35 Software update verification message box



NOTE: To verify whether or not a software update has been successfully applied, go to *System > Diagnostics > View Log File window* and select “*Software Update Log (patch.log)*”. See *View Log File window* for more information.

- Click **OK** to close the alert box and to proceed. This action opens the connection failure alert box, indicating that the connection to the Web Filter server has been lost due to the software update application:

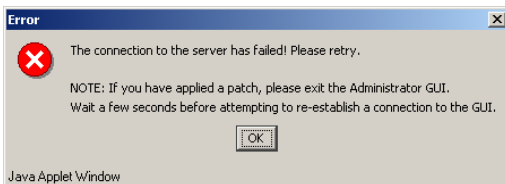

Fig. 2:1-36 Connection failure alert box

6. Click **OK** to close the alert box.
7. In the navigation toolbar, click **Quit** to exit the Web Filter console.
8. Wait a few minutes, and then log back into the Web Filter console again.



NOTE: M86 recommends performing a backup of configuration files after applying a software update. (See the Backup/Restore window in this chapter for information on performing a backup.)

Enable/Disable Software Update Type Downloads

The Enable/Disable Software Update Type Download frame is used for enabling or disabling the download of Limited Availability (LA) and Beta software updates.

By default, all active Web Filters will receive General Availability (GA) software downloads. Clicking the checkbox preceding LA or Beta enables/disables the request to download that software update type.

LA and Beta software updates offer a preview of software to be released GA. LA software updates can be used in a production environment, but Beta software updates should not be used in a production environment.

To enable/disable LA or Beta software updates, after checking/unchecking the corresponding checkbox, click **Apply**. When available, the requested software update type(s) display in the Available Software Updates frame.



NOTE: Selecting/de-selecting “LA” also selects/de-selects “Beta”.

First Time LA/Beta Software Install Procedures

The steps in this sub-section pertain to the first acceptance and installation of Limited Availability or Beta software updates.

1. In the Available Software Updates frame (see Fig. 2:1-37), two buttons are available for the LA/Beta software update: README and Apply Now.

Click **Apply Now** to open the Software Update Installation Key pop-up box:

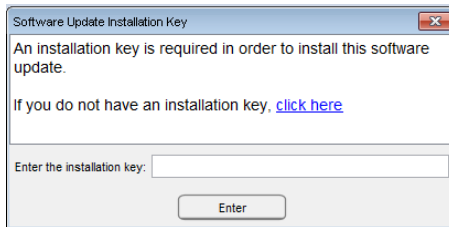



Fig. 2:1-37 Software Update Installation Key box

2. If you have an installation key for receiving LA or Beta software updates, go to the **Enter the installation key** field and type in that key.

 **NOTE:** If you do not have an installation key, click the link “[click here](#)” to go to the M86 Security Web site where you will need to log in and request an installation key.

3. Click **Enter** to launch the applicable dialog box for accepting the software update type (see Fig. 2:1-38 for LA and Fig. 2:1-39 for Beta):

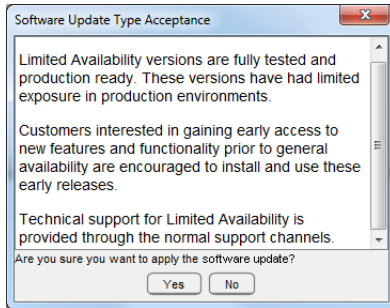

Fig. 2:1-38 LA software acceptance box

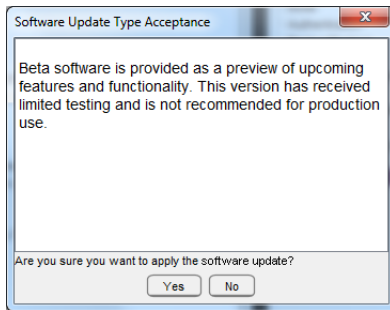



Fig. 2:1-39 Beta software acceptance box

4. Read the description for the software type to be installed (LA or Beta), and then click **Yes** to close the software acceptance dialog box and to open the End User License Agreement dialog (see Fig. 2:1-34).
5. Follow steps 4 and 8 in the preceding General Software Installation Procedures sub-section to accept the EULA and apply the software update.

Undo an Applied Software Update

 **NOTE:** Only the most recently applied software update can be uninstalled.

 **WARNING:** If a software update is uninstalled, configuration settings will revert to the previous settings, before the software update was applied.

To unapply a software update:

1. Go to the History of Software Updates frame and select the software update to be unapplied.
2. Click **Undo**.

Software Update Log window

The Software Update Log window displays when Software Update Log is selected from the Software Update menu. This window is used for viewing the software update log that provides the status on the Web Filter's software update activity, including checks for new software updates, and downloaded and applied software updates.

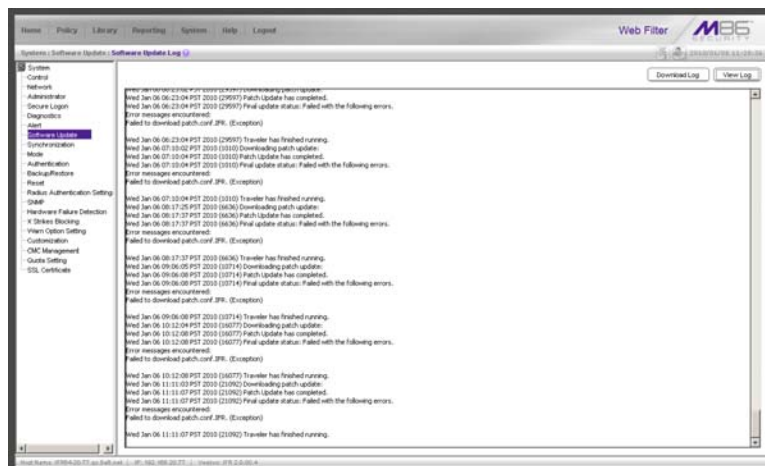

Fig. 2:1-40 Software Update Log window

View Log Contents

Click **View Log** to display contents of the log in the frame below with the status of the software update.

Download Log, View, Print Contents

Download the Log

1. Click **Download Log** to open the alert box containing a message on how to download the log file to your workstation, if using Windows XP.
2. Click **OK** to close the alert box. Two pop-up boxes open:
 - A second alert box asks you to confirm that the file was successfully saved to your machine. Click **OK** in this box after the download is completed.
 - In the file download dialog box, select the “save” option; this action opens the window on your workstation where you specify the filename for the file and where to save the file.
3. Select the folder in which to save the file, and then enter the **File name**, retaining the “.zip” file extension. Click **Save** to begin downloading the zip file to your workstation.



NOTE: Proceed to View the Contents of the Log for information on viewing or printing the contents of the log file.

4. After the file has successfully downloaded to your workstation, click **OK** to close the alert box asking you to verify that the software update log file was successfully saved.

View the Contents of the Log

Once the software update log file has been downloaded to your workstation, you can view its contents.

1. Find the log file in the folder, and right-click on it to open the pop-up menu:

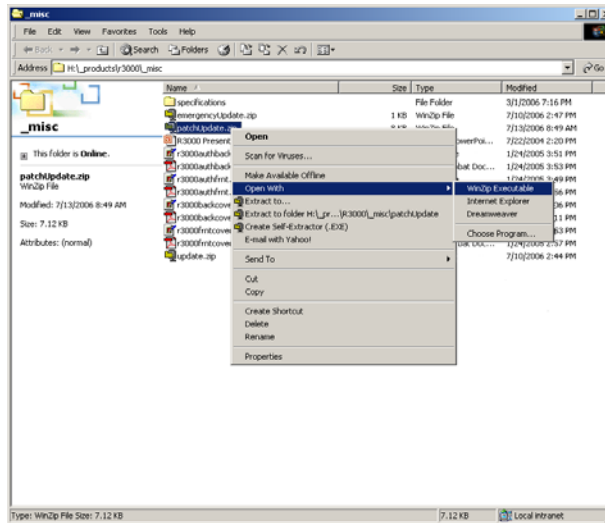

Fig. 2:1-41 Folder containing downloaded file

2. Choose “Open With” and then select a zip file executable program such as “WinZip Executable” to launch that application:

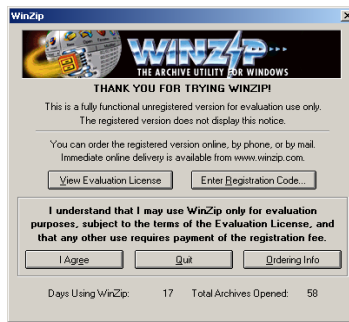

Fig. 2:1-42 WinZip Executable program

- If using WinZip, click **I Agree** to open the window containing the zip file:

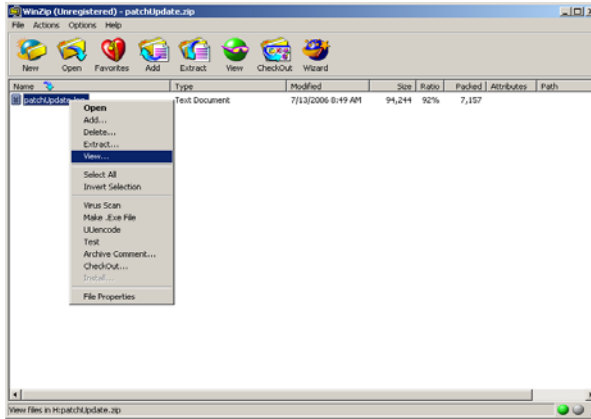

Fig. 2:1-43 WinZip window

- Right-click the zip file to open the pop-up menu, and choose "View" to open the View dialog box:

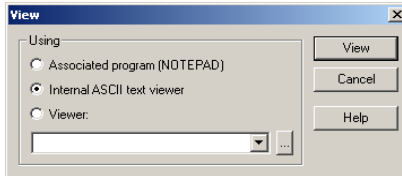

Fig. 2:1-44 View dialog box

- Select "Internal ASCII text viewer", and then click **View** to open the View window containing the log file contents:

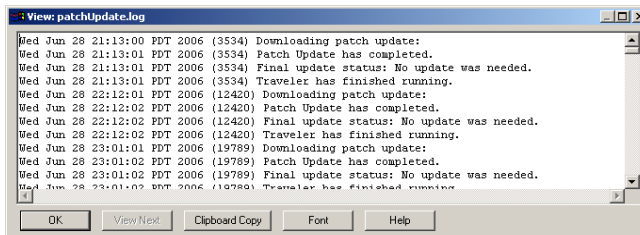

Fig. 2:1-45 View window

Save, Print the Log File Contents

With the log file displaying correctly formatted in WinZip's View window, if you wish to save or print the contents of this file:

1. Click **Clipboard Copy**, wait for the dialog box to open and confirm that the text has been copied to the clipboard, and then click **OK** to close the dialog box.
2. Open Notepad—in Windows XP: Start > All Programs > Accessories > Notepad
3. Paste the contents from the clipboard into the Notepad file.

The correctly formatted Notepad file can now be saved and/or printed.

Synchronization

By default, the Synchronization pop-up menu includes the Setup option that lets you specify the Web Filter server's function on the network: whether it will be a stand alone box, or whether it will send profile/library setting changes to—or receive such setting changes from—another Web Filter. If the Web Filter is set up to either send or receive profile/library setting changes in the aforementioned manner, the menu option for Status also becomes available in the pop-up menu. If the Web Filter is set up to send profile/library setting changes, that Web Filter will function as a Centralized Management Console, and thus the CMC Management topic becomes available in the navigation panel.



NOTES: For an overview on synchronization, see Chapter 3: *Synchronizing Multiple Units*, from the *Introductory Section*.

If synchronizing a Web Filter with a WFR, see http://www.m86security.com/software/8e6/hlp/r3000/files/1system_sync_versions.html for software version compatibility.



WARNING: This version of synchronization only supports the use of unique IP addresses throughout a network.

Setup window

The Setup window displays when Setup is selected from the Synchronization menu. This window is used for establishing the function of the Web Filter, especially if there is more than one Web Filter on the network. When there are multiple Web Filters, it is important to set up one as a "source" server and others as "targets," so that user profiles and/or library settings can be copied to other servers. This process ensures that all servers run in parallel on the network, thereby eliminating the need to manually configure profile and library settings on each server.

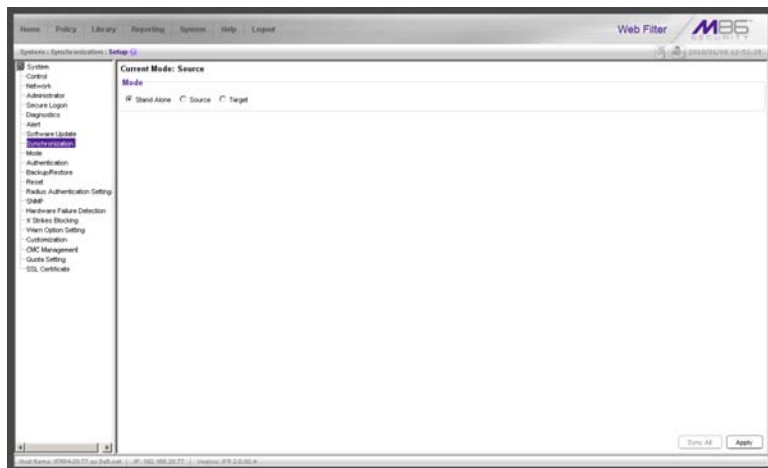

Fig. 2:1-46 Setup window, Stand Alone mode

Using Only One Web Filter on the Network

By default, the “Stand Alone” mode is selected in the Mode frame. This indicates that all settings on the Web Filter that is currently being configured apply only to that Web Filter.

For the Stand Alone mode setting:

1. In the Mode frame, click “Stand Alone”.
2. Click **Apply**.

Using More than One Web Filter on the Network

Using the synchronization process, all target servers are updated with profile/library setting changes, so that no matter which Web Filter the user’s client PC accesses, the user’s Internet session will be appropriately filtered and blocked.

Set up a Web Filter to be a Source Server

A Web Filter configured to be a “source” server will send profile/library setting changes to other Web Filter (“target”) servers.

WARNING: *If a Web Filter is set up in the Source mode with a Network Address Translation (NAT) device between the source and target server(s), be sure that ports 26262, 26268, and 88 are open on the source server. This setup is required so that the source server can communicate with the target server(s).*

For the Source mode setting:

1. In the Mode frame, click “Source” to display the Source mode view:

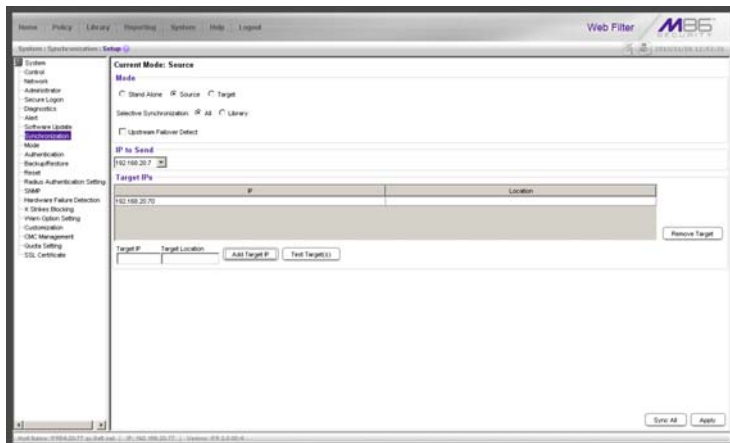

Fig. 2:1-47 Setup window, Source mode

2. At the **Selective Synchronization** field, by default “All” is selected. This choice includes both profile and library setting changes. Choose “Library” if only library category additions/deletions (including search engine keywords and URL keywords additions/deletions)—and not profiles—should be synced to target servers.
3. By default, the “Upstream Failover Detect” checkbox is unpopulated. Click this checkbox if this source server will be set up to detect any failed Web Filter “node” and filter that target server. Using this option, the source server will function as the “upstream” Web Filter and all target servers will function as “downstream” Web Filters.



NOTES: *In order to use the failover detection feature, for each target Web Filter, Appliance Watchdog software release 3.0.00 must first be installed on a separate workstation and set up to watch that Web Filter. Go to <http://www.m86security.com/support/Watchdog/documentation.asp> to download this release.*

If using the failover detection feature:

- *Local Filtering on this source server must be enabled*
- *Troubleshooting on this source server must be disabled*
- *The Operation Mode on this source server and all target servers must be set to use the same mode*
- *The mobile mode cannot be used*
- *If “Library” Selective Synchronization is enabled, end users for the failed Web Filter “node” might be given the Global Group Profile instead of their active filtering profiles*
- *If a target server fails, the Range to Detect Settings window displays a Node tab with IP range information for the failed “downstream” server.*

4. In the IP to Send frame, select either the LAN 1 or LAN 2 IP address from the **IP to Send** pull-down menu. This IP address will be used for sending profile/library setting changes to the target server(s).

 **NOTE:** LAN 1 and LAN 2 IP addresses that display in this menu were previously entered in the LAN Settings window on this server.

5. In the Target IPs frame, enter the **Target IP** address of the Web Filter that will receive profile/library setting changes from this server being configured.

 **NOTE:** If a target server is set up with a NAT device, the NAT IP address must be used instead of the target server's own IP address.

6. An entry in the **Target Location** field is optional. This alphanumeric entry serves as a label for readily identifying the server being configured.
7. Click **Add Target IP** to include this IP address—and corresponding Location information, if applicable—in the list box.

The following optional steps can be performed:

- Follow steps 5 to 7 for each server that should receive profile/library setting changes from this server being configured.
- Click **Test Target(s)** to open an alert box that provides the server mode status for each IP address you entered. Click **OK** to close the alert box, and make any adjustments, if necessary.
- To remove an IP address from the list box, select it and click **Remove Target**.

 **NOTE:** This test only verifies whether this server can contact the target server(s). In order for synchronization to be operable on the network, the target server(s) must also be able to contact this source server being configured.

8. Click **Apply** after all settings have been made. Note that the CMC Management topic becomes available in the navigation panel for this source server when settings in this window are saved.

Sync All Target Servers with the Same Settings

If all target servers have been configured and now need to be set with the same settings, click **Sync All** from the source server. *This action should only be performed if all target servers need to have the same user filtering profile/library settings as the source server.*

Two scenarios in which this feature might be used involve restoring backup data to the Web Filter:

- In the first scenario, library configurations from a previous date in time are restored to the source server, and each target server needs to have these same library configurations as well. Sync All should be clicked after entries are made in the Backup/Restore window.
- In the second scenario, the source server has failed and needs to be replaced with another server. One of the target servers is promoted to function as the new source server. The newly designated source server should be updated with the most recent configurations, via the latest valid backup from the failed source server. Once this data is restored to the new source server, each target server should be sent these same library configurations using the Sync All button.



NOTE: See the Backup/Restore window for information on restoring data to a server.

Set up a Web Filter to be a Target Server

A Web Filter configured to be a target server will receive profile/library setting changes from the source server only.



WARNING: If a Web Filter server is set up in the Target mode with a NAT device between the target and source server, be sure that ports 26262 and 26268 are open on the target server. This setup is required so that the target server can communicate with the source server.

For the Target mode setting:

1. In the Mode frame, click “Target” to display the Target mode view:

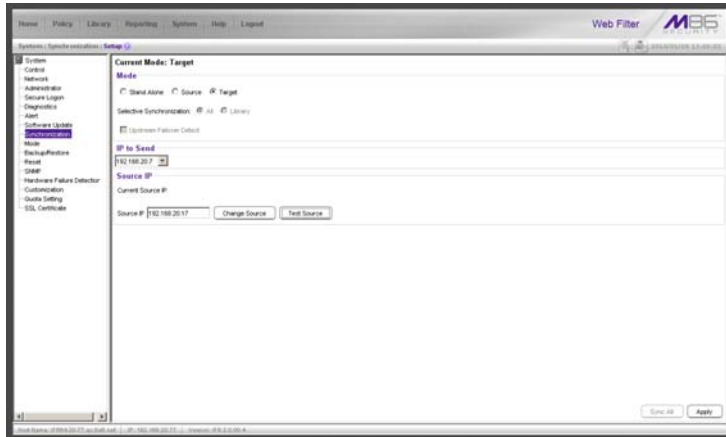

Fig. 2:1-48 Setup window, Target mode

In the IP to Send frame, the LAN1 and LAN2 IP addresses set up in the LAN Settings window on this server display in the **IP to Send** pull-down menu.

2. In the Source IP frame, enter the **Source IP** address to use for sending profile/library setting changes to this server being configured.



NOTE: If a source server is set up with a NAT device, the NAT IP address must be used instead of the source server’s own IP address.

3. Click **Test Source** to open an alert box that provides the server mode status for the IP address you entered.
4. Click **OK** to close the alert box, and make any adjustments, if necessary.
5. After validating the source IP address, click **Change Source** to display this IP address in the **Current Source IP** display field.

6. Click **Apply** after all settings have been made.



NOTE: This test only verifies whether this server can contact the source server. In order for synchronization to be operable on the network, the source server must also be able to contact this target server being configured.

Status window

The Status window displays when Status is selected from the Synchronization menu. This menu selection is available only if this server currently being configured is either set up in the Source mode or Target mode.

If set up in the Source mode, this window is used for verifying that profile updates are being sent to the target server(s), as in the example below:

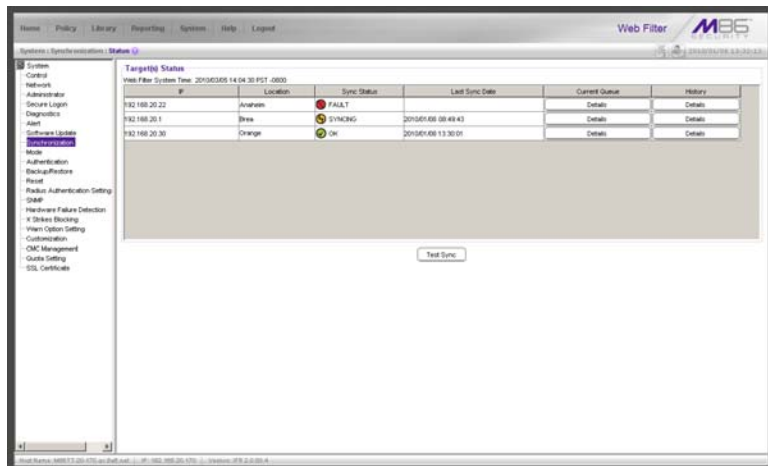

Fig. 2:1-49 Status window, Source mode

If set up in the Target mode, this window is used for verifying that profile/library setting updates are being received from the source server.

View the Sync Status of Targets from the Source

If the server is set up in the Source mode, the Web Filter System Time displays at the top of the Target(s) Status frame. This is the current date and time from the Web Filter—using the YYYY/MM/DD and HH:MM:SS format—and includes the UTC code for the time zone.

For each target server, the grid displays the IP address, Location, and Sync Status ("OK" if the target server can be accessed by the source server, "SYNCING" if synchronization is occurring, and "FAULT" if the target server cannot be reached or if there is a problem with synchronization). The Last Sync Date column displays the date and time synchronization last occurred for the target server.



TIPS: *The order in which columns display in the grid can be changed by clicking the column header and sliding the column to another position in the grid.*

To change the sort order, click the header of a column. All rows will sort in descending order by that column.

If text in any column displays truncated—followed by ellipses (...)—place the cursor over the beginning or ending of the column header. When the <—> character displays in place of the cursor, you can expand the width of the column. You also can use the scrollbar beneath the grid to view information to the right of the last column.

View Items in the Queue

If a "FAULT" message displays in the Sync Status column for a target server, items still remain in the queue, waiting to be synced.

To view items in the queue for a specified target server:

1. In the Current Queue column for that server, click **Details** to open the Queue of Target pop-up window:

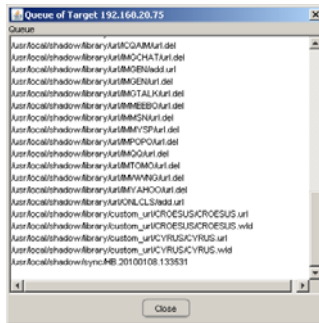

Fig. 2:1-50 Queue of Target pop-up window

2. Click **Close** to close the pop-up window.

View Items Previously Synced to the Server

To view items previously synced to a specified target server:

1. In the History column for that server, click **Details** to open the History of Target pop-up window.
2. Select the maximum **Last Number of Lines** from the pull-down menu (100, 200, 300, 400, 500) for the most recent synchronization history that you wish to view.
3. Click **View** to display lines of items in the History Log:

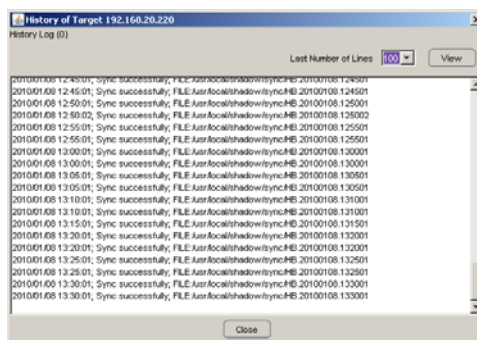

Fig. 2:1-51 History of Target pop-up window

4. Click **Close** to close the pop-up window.

Place Items in Queue for Syncing

To place new sync items in queue for the target server(s), click **Test Sync**.

View the Sync Status of the Target Server

If the server is set up in the Target mode, the Web Filter System Time displays above the Target Sync Status frame. This is the current date and time from the Web Filter—using the YYYY/MM/DD and HH:MM:SS format—and includes the UTC code for the time zone.

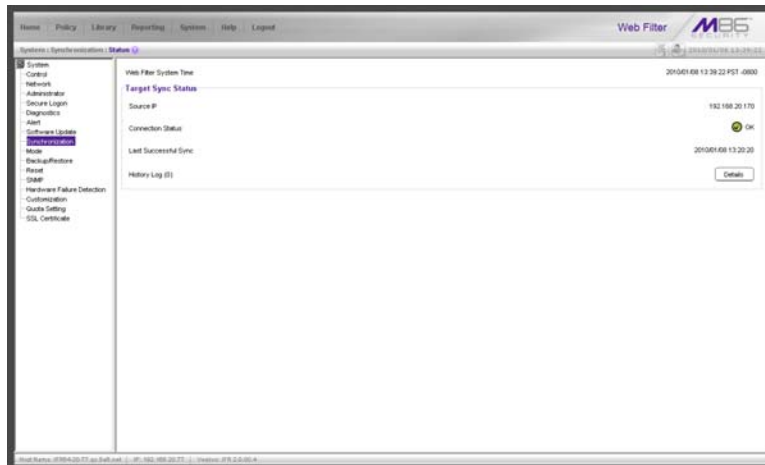

Fig. 2:1-52 Status window, Target mode

The Target Sync Status frame includes the following information:

- **Source IP** - The IP address of the source server displays.
- **Connection Status** - “OK” or “FAULT” displays, indicating whether or not there is a connection to the source server.

- **Last Successful Sync** - The date and time of the last successful synchronization displays, using the YYYY/MM/DD and HH:MM:SS format.
- **History Log** - Click the **Details** button to open the History of Target pop-up window. See View Items Previously Synced to the Server in this section for information on accessing and viewing the contents of this window.

Mode

Mode includes options for configuring the Web Filter to filter the network. Click the Mode link to view a menu of sub-topics: Operation Mode and Proxy Environment Settings.

Operation Mode window

The Operation Mode window displays when Operation Mode is selected from the Mode menu. This window is used for specifying the operational mode the Web Filter will use to filter the network, and the settings the Web Filter will use for “listening to” traffic and sending traffic. This window is also used for configuring the Web Filter to perform other operational capacities. Using the mobile mode in conjunction with one of the three filtering modes (Invisible, Router, or Firewall) the Web Filter will also filter end users whose machines are not located in house. In the Mobile Only mode, the Web Filter will solely filter workstations outside of the server location. In the ICAP mode, the Web Filter off-loads specific content normally handled by a Web Filter, such as filtering.

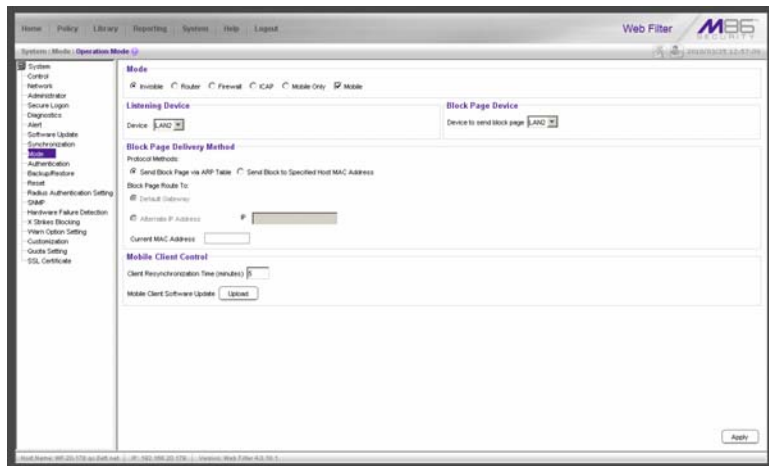

Fig. 2:1-53 Operation Mode window

Set the Operation Mode

The default Mode setting is “Invisible”. To change this setting, click the radio button corresponding to “Router”, “Firewall”, “ICAP”, or “Mobile Only”. Selecting ICAP would make the Web Filter function in a capacity other than filtering users on the network.

If there are users with mobile PCs physically located outside of the organization and you wish to filter these units on this Web Filter, click the “Mobile” checkbox to use the mobile mode in conjunction with the selected filtering mode.



WARNING: *If using the router or firewall mode, M86 recommends contacting one of our solutions engineers if you need any assistance with setup procedures.*

Specify the Listening Device

In the Listening Device frame, select the default listening **Device** for the selected mode: “LAN1” or “LAN2”.

If using the invisible mode, “LAN1” displays by default. If using the router or firewall mode, you may need to select the network card that will be used to “listen to”—as opposed to “send”—traffic on the network.

Specify the Block Page Device

In the Block Page Device frame, “LAN2” displays as the default device for sending block pages to client PCs in the invisible mode.



TIP: *For the invisible mode, the block page device should be a different device than the one selected in the Listening Device frame. For the router and firewall modes, the device should be the same as the one selected in the Listening Device frame.*

If using the router or firewall mode, at the **Device to send block page** pull-down menu, you may need to choose the network card that will be used to send the block page to client PCs.



NOTES: After making all selections in this window, click **Apply**.

The LAN IP address saved for the Device to send block page will display in the IP field at the bottom of the Administrator console.

Invisible Option: Specify the Block Page Delivery

The Block Page Delivery Method frame displays if the Invisible operation mode is selected. Specify the block page delivery method by making the following selection(s):

Choose from either of the two **Protocol Methods**:

- “Send Block Page via ARP Table” - this option uses the Address Resolution Protocol method to find the best possible destination MAC address of a specified host, usually the Web Filter gateway.
- “Send Block to Specified Host MAC Address” - using this preferred method, the block page will always be sent to the MAC address of a specified host, usually the Web Filter gateway.

Using this option, choose from either of the two **Block Page Route To** selections:

- “Default Gateway” - this option indicates that the default gateway on your network will be used for sending block pages. If the invisible mode is selected, “Default Gateway” displays by default as the Block Page Route To selection.
- “Alternate IP Address” - this option should be used if block pages are not being served.

Enter the **IP** address of the router or device that will serve block pages.



NOTES: *The Current MAC Address displays if there is a resolution between the IP address and the MAC address of the router or device used for serving block pages.*

If an Alternate IP Address is used, that address must be resolved with the MAC address in order for block pages to be served to client PCs.

ICAP Option: Specify ICAP Server Settings

The ICAP Server Settings frame displays if the ICAP operation mode is selected. This option should be used if this Web Filter is designated to function with an Internet Content Adaptation Protocol (ICAP) server to off-load specific content normally processed by the Web Filter, such as Internet filtering.

With an ICAP server, the Web Filter will not capture any network packets but will solely work with ICAP requests from an ICAP client (proxy server). When an end user makes a request for Internet content, this request is routed to the proxy server, which then submits the request to the ICAP server. The ICAP server sends back a response to the proxy server—which may send the request to the original Web Filter in some network setups, and then return a response to the proxy server. Based on the end user's filtering profile, the proxy server either fulfills the request or returns a block page.

The ICAP Server Settings frame is used for configuring options response settings for the ICAP Web Filter server:

1. In the **ISTAG** field, enter the IStag (ICAP Service Tag) which is a 128-maximum alphanumeric quoted string of data (including quotation marks but never the null character) used in the options response-header field. This tag provides a way for ICAP servers to send a service-specific "cookie" to ICAP clients so that the ICAP server can communicate with the ICAP client. For example:
"835nb0-20a5-3e52671"

2. In the **URI** field, enter the Uniform Resource Identifier that must specify the complete hostname and path of the resource being requested. For example: `icap://icap.logo.com:1344/services/icap-services`



NOTE: *This string must match what is set up on the ICAP server in order for the ICAP client's request to be accepted by the ICAP server.*

3. In the **Max Connections (4-150)** field, enter the maximum connections the ICAP server will allow for ICAP clients. By default, 30 displays.
4. In the **Options TTL in Sections (0-86400)** field, enter the time (in seconds) in which the options response is valid. By default, 3600 displays.
5. In the **Preview Bytes (0-4096)** field, enter the number of bytes to be included in the response header to be sent by the ICAP client for preview by the ICAP server, before the entire request is submitted to the ICAP server. By default, 1024 displays.
6. In the **Port** field, enter the port number to be used by the ICAP server. By default, this port number is 1344.



NOTE: *The port number must be the same one entered for the URI.*



WARNING: *Go to http://www.m86security.com/software/8e6/hlp/r3000/files/1system_opmode_icap.html to review a list of items to be considered when using the ICAP mode.*

Mobile Options: Specify the Mobile Client Control

The Mobile Client Control frame displays if the Mobile Only operational mode or the Mobile option is selected. Either selection should be made if this Web Filter will additionally filter end user workstations physically located outside of the organization.



NOTE: See Appendix D: Mobile Client for information on setting up and using the Mobile Client.

Apply Operation Mode Settings

Click **Apply** to apply your settings in the Mode frame.

Proxy Environment Settings window

The Proxy Environment Settings window displays when Proxy Environment Settings is selected from the Mode menu. This window is used for specifying whether the Web Filter is in a proxy environment, if the default Web server port number 80 will be enabled, and if HTTPS traffic will be allowed to pass without being overblocked.

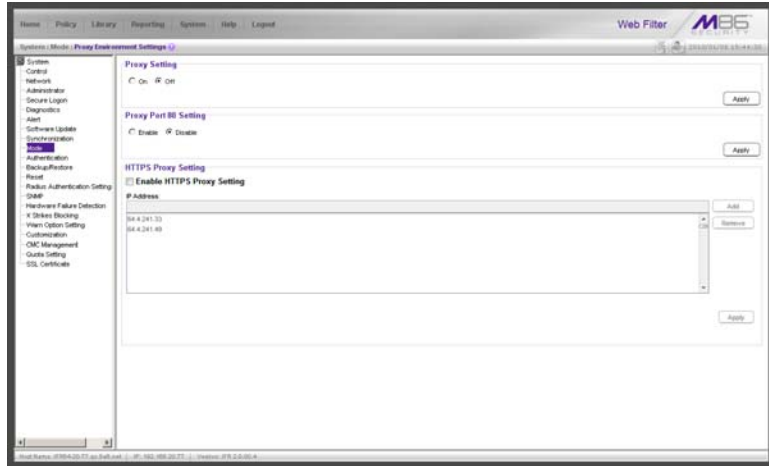

Fig. 2:1-54 Proxy Environment Settings window



NOTE: Basic Proxy Authentication must be used if using HTTPS in a proxy environment. The Web Filter has been tested with ISA, Blue Coat, and Squid proxies.

Use a Local Proxy Server

In the Proxy Setting frame, the default setting is “Off”. To specify that a local proxy server is used in the environment:

1. Click the “On” radio button. This selection indicates that the Web Filter will perform a reverse lookup on packets to detect the source address and origin of packets.
2. Click **Apply** to apply your setting.

Use Proxy Port 80

In the Proxy Port 80 Setting frame, the default setting is “Disable”. To specify that the public proxy server will channel “https” traffic through Port 80:

1. Click the radio button corresponding to “Enable”.
2. Click **Apply** to apply your setting.

Enable HTTPS Filtering

In the HTTPS Proxy Setting frame, indicate whether HTTPS filtering will be allowed to pass by making these settings:

1. Click **Enable HTTPS Proxy Setting** to activate the objects in this frame.
2. Enter the **IP Address** of each proxy server to recognize HTTPS traffic, and then click **Add** to include that IP address in the list box below.



TIP: To remove an IP address from the list box, select it and then click **Remove**.

3. Click **Apply** to enable your settings.

Authentication

Authentication includes options for configuring the Web Filter to authenticate and re-authenticate users on the network. Click the Authentication link to view a menu of sub-topics: Enable/Disable Authentication, Authentication Settings, and Authentication SSL Certificate.



NOTES: *Information about these sub-topics can be found in the M86 Web Filter Authentication User Guide.*

The Authentication topic and sub-topics do not display if the synchronization feature is used, and this server being configured is set up in the Target mode to synchronize both profile and library setting changes.

Backup/Restore

Backup/Restore window

The Backup/Restore window displays when Backup/Restore is selected from the navigation panel. This window is used for saving configuration settings and/or custom library additions/deletions on or off the server, and for restoring these settings/modifications later, if necessary.

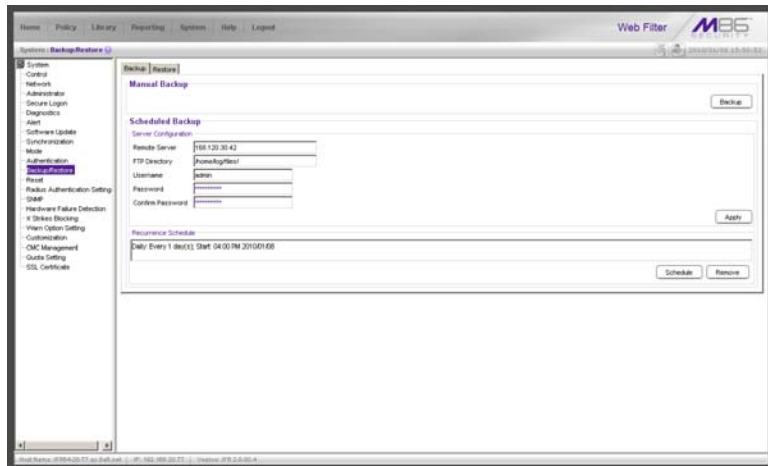

Fig. 2:1-55 Backup/Restore window, Backup tab



WARNING: A backup should be created and downloaded off the Web Filter server whenever a change is made to filtering settings on the Web Filter server.

For each backup configuration created or uploaded via this window, a row is added to the Backup Configurations grid in the Restore tab. The newly added row includes the following information: Date the backup was executed, Filename of the backup file, general information about the Content of the file, and a Comment about the file.



TIPS: *The order in which columns display in the grid can be changed by clicking the column header and sliding the column to another position in the grid.*

To change the sort order, click the header of a column. All rows will sort in order by that column.

If text in any column displays truncated—followed by ellipses (...)—place the cursor over the beginning or ending of the column header. When the $\leftarrow\rightarrow$ character displays in place of the cursor, you can expand the width of the column. You also can use the scrollbar beneath the grid to view information to the right of the last column.

Backup Procedures

M86 recommends performing backup procedures whenever changes are made to system configurations or to library configurations. By creating backup files and saving these files off the Web Filter, prior server settings can later be retrieved and uploaded to the Web Filter in the event that current settings are incorrect, or if you wish to revert to settings from a previous backup. Additionally, backup files are useful if the current server fails. These backup files can be uploaded to a new server, eliminating the need to re-enter the same settings from the old Web Filter in the console of the new Web Filter.



NOTE: *See Server Maintenance Procedures from the Introductory Section's Chapter 3: Synchronizing Multiple Units, for an overview on establishing backup procedures when using more than one Web Filter unit on the network.*

Perform a Backup on Demand

1. In the Manual Backup frame on the Backup tab, click **Backup** to open the Web Filter Backup dialog box:

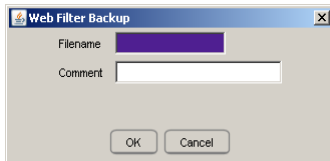

Fig. 2:1-56 Web Filter Backup dialog box

2. Type in the **Filename** for the backup file.
3. Type in a descriptive **Comment** about that file.
4. Click **OK** to close the dialog box, and to open the Backup Restore alert box that informs you it may take some time to back up configurations, based on the amount of data to be saved.
5. Click **OK** to close the Backup Restore alert box. After configurations have been successfully saved, the Message alert box opens to display a confirmation message.
6. Click **OK** to close the Message alert box, and to add a new row for that file to the Backup Configurations grid in the Restore tab.



NOTE: Once the file is added to the grid, it can be downloaded and saved on another machine, if necessary.

Schedule a Backup

Configure FTP Server Settings

1. In the Server Configuration section of the Scheduled Backup frame, enter the IP address of the **Remote Server**.
2. In the **FTP Directory** field, enter the path where log files will be stored.
3. In the **Username** field, type in the valid username for FTP transfers.



NOTE: *The passive mode is used for transferring backup files to the server via FTP.*

4. In the **Password** and **Confirm Password** fields, type in the password for the username specified in the FTP Directory field.
5. Click **Apply** to open the Server Configuration dialog box asking if you wish to save your settings.



TIP: *Click No to close the dialog box without saving your settings.*

6. Click **Yes** to close the dialog box and to open a Message alert box indicating that your settings have been saved.
7. Click **OK** to close the alert box.

You can now set up a schedule for a backup in the Recurrence Schedule section of the Scheduled Backup frame.

Create a Backup Schedule

1. In the Recurrence Schedule section of the Scheduled Backup frame, click **Schedule** to open the Scheduled Backup pop-up box:

Fig. 2:1-57 Scheduled Backup pop-up box

2. In the Recurrence duration time frame, specify **Start** and **End** time range criteria:
 - a. Select from a list of time slots incremented by 15 minutes: “12:00” to “11:45”. By default, the Start field displays the closest 15-minute future time, and the End field displays a time that is one hour ahead of that time. For example, if the time is currently 11:12, “11:15” displays in the Start field, and “12:15” displays in the End field.
 - b. Indicate whether this time slot is “AM” or “PM”.
 - c. Today’s date displays using the MM/DD/YY format. To choose another date, click the arrow in the date drop-down menu to open the calendar pop-up box:



In this pop-up box you can do the following:

- Click the left or right arrow at the top of this box to navigate to the prior month or the next month.
- Double-click a date to select it and to close this box, populating the date field with that date.
- Click **Today** to close this box, populating the date field with today's date.

3. In the Recurrence pattern frame, choose the frequency this time profile will be used:

- **Daily** - If this selection is made, enter the interval for the number of days this time profile will be used. By default, "1" displays, indicating this profile will be used each day during the specified time period.

If **5** is entered, this profile will be used every five days at the specified time.

- **Weekly** - If this selection is made, enter the interval for the weeks this time profile will be used, and specify the day(s) of the week ("Sunday" - "Saturday"). By default, "1" displays and today's day of the week is selected. If today is Tuesday, these settings indicate this profile will be used each Tuesday during the specified time period.

If **2** is entered and "Wednesday" and "Friday" are selected, this profile will be used every two weeks on Wednesday and Friday.

- **Monthly** - If this selection is made, first enter the interval for the months this time profile will be used, and next specify which day of the month:
 - If **Day** is chosen, select from “1” - “31”.
 - If a non-specific day is chosen, make selections from the two pull-down menus for the following:
 - week of the month: “First” - “Fourth”, or “Last”
 - day of the month: “Sunday” - “Saturday”, “Day”, “Weekday”, “Weekend”.

“By default, “1” displays and today’s Day of the month is selected. If today is the 6th, these settings indicate this profile will be used on the 6th each month during the specified time period.

If **3** is entered and the “Third” “Weekday” are selected, this profile will be used every three months on the third week day of the month. If the month begins on a Thursday (for example, May 1st), the third week day would be the following Monday (May 5th in this example).

- **Yearly** - If this selection is made, the year(s), month, and day for this time profile’s interval must be specified:

First enter the year(s) for the interval. By default “1” displays, indicating this time profile will be used each year.

Next, choose from one of two options to specify the day of the month for the interval:

- The first option lets you choose a specific month (“January” - “December”) and day (“1” - “31”). By default the current month and day are selected.
- The second option lets you make selections from the three pull-down menus for the following:
 - week of the month: “First” - “Fourth”, or “Last”
 - day of the month: “Sunday” - “Saturday”, “Day”,

“Weekday”, “Weekend”

- month: “January” - “December”.

By default, the “First” “Sunday” of “January” are selected.

If **2** is entered and the “First” “Monday” of “June” are selected, this profile will be used every two years on the first Monday in June. For example, if the current month and year are May 2010, the first Monday in June this year would be the 7th. The next time this profile would be used will be in June 2012.

4. In the Range of recurrence frame, the **Start** date displays greyed-out; this is the same date as the Start date shown in the Recurrence duration time frame. Specify whether or not the time profile will be effective up to a given date:
 - **No end date** - If this selection is made, the time profile will be effective indefinitely.
 - **End by** - If this selection is made, by default today's date displays using the MM/DD/YY format. To choose another date, click the arrow in the date drop-down menu to open the calendar pop-up box. (See the information on the previous pages on how to use the calendar box.)
5. Click **Apply** to close the Scheduled Backup pop-up box and to open a Message alert box informing you that the backup schedule will be activated at the specified time.
6. Click **OK** to close the Message alert box. The Backup/Restore window now shows the schedule in the Recurrence Schedule section of the Scheduled Backup frame.

Remove a Backup Schedule

Click **Remove** to remove the schedule from the Recurrence Schedule section of the Scheduled Backup frame.

Download a File

To download a file to your machine:

1. In the Restore tab, select the file from the Backup Configurations grid:

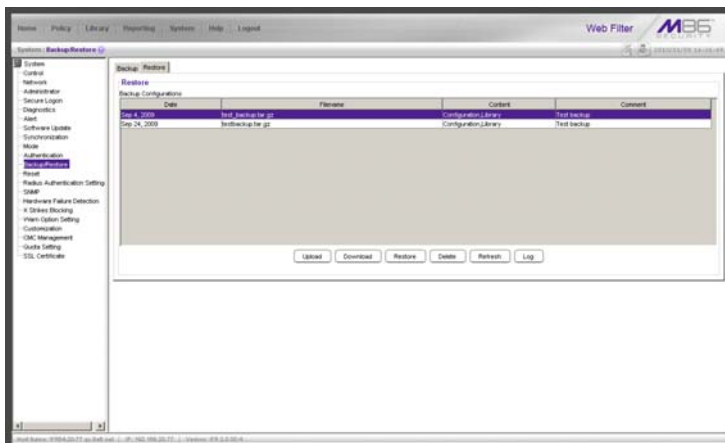



Fig. 2:1-58 Backup/Restore window, Restore tab

2. Click **Download** to open the alert box containing a message on how to download the log file to your workstation, if using Windows XP.
3. Click **OK** to close the alert box and to open the file download dialog box.
4. Select the “save” option; this action opens the window on your workstation where you specify the filename for the file and where to save the file.
5. Select the folder in which to save the file, and then enter the **File name**, retaining the “.gz” file extension. Click **Save** to begin downloading the .gz file to your workstation.

Perform a Restoration

To restore backup data to the server, the backup file must be listed in the Backup Configurations grid in the Restore tab, and the restoration function must be executed. If the backup file is not included in the Backup Configurations grid, you must upload it to the server.

 **WARNING:** Be sure the file you are restoring uses the same version of the software currently used by the Web Filter Administrator console. Refer to the Local Software Update window for available updates to the Web Filter's software. (See the Local Software Update window for more information about software updates.)

Upload a File to the Server

To upload a .gzip file to the server:

1. Click **Upload** to open the Upload Backup GZIP File pop-up window:

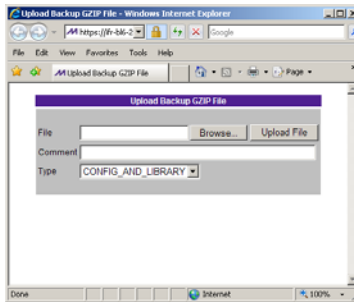

Fig. 2:1-59 Upload GZIP File pop-up window

2. Click **Browse...** to open the Choose file window.
3. Select the file to be uploaded. After the file is selected, the Choose file window closes.
4. In the pop-up window, type in a **Comment** about the file.
5. Select the **Type** of file to be uploaded (CONFIG_ONLY, LIBRARY_ONLY, or both CONFIG_AND_LIBRARY).
6. Click **Upload File** to upload this file to the server. If the file is successfully uploaded, the pop-up window's banner name says: "Upload Successful." After a few seconds, the pop-up window closes.
7. Click **Refresh** to display a new row for the uploaded file in the Backup Configurations grid.

Restore Configurations to the Server

To restore configurations or library modifications from a previous backup:

1. Select the file from the Backup Configurations grid.
2. Click **Restore** to overwrite the current settings.

Remove a Backup File

To remove a file from the Backup Configurations grid:

1. Select the file.
2. Click **Delete**.

View Backup and Restoration Details

To view details on backup and/or restoration activities:

1. Click **Log** to open the Backup/Restore Log pop-up box:



Fig. 2:1-60 Backup/Restore pop-up box

The pop-up box includes rows of data about backup and restore processes performed via the Backup/Restore window.

The following information displays for each row: the date and time a process was attempted to be executed, and a Message indicating whether that process succeeded or failed.

2. Click **OK** to close the pop-up box.

Reset

Reset window

The Reset window displays when Reset is selected from the navigation panel. This window is used for resetting the server back to the default settings when the box was first acquired.



Fig. 2:1-61 Reset window



WARNING: When Reset is clicked, all settings made on the Web Filter will be removed and the box will be restored to its original state. Any software updates applied to the server subsequent to receiving this box will need to be reapplied.

Reset All Server Settings

Click **Reset** to reset the box to the original default settings.

Radius Authentication Settings

Radius Authentication Settings window

The Radius Authentication Settings window displays when Radius Authentication Settings is selected from the navigation panel. This window is used for controlling filtering levels of dial-up users.

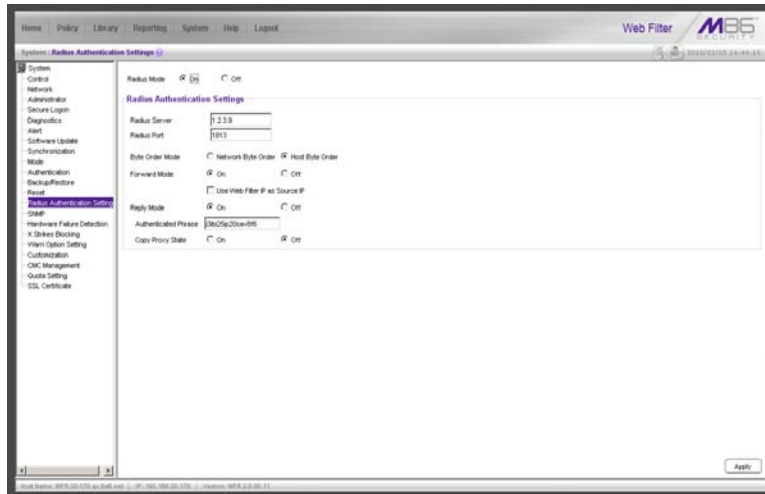



Fig. 2:1-62 Radius Authentication Settings window

 **NOTE:** The Radius Authentication Settings topic does not display if the synchronization feature is used, and this server being configured is set up in the Target mode to synchronize both profile and library setting changes.

The Radius feature uses an external Radius accounting server that determines which accounts will be filtered and how they will be filtered. The user profile in the Radius accounting server holds the filter definition for the user.

Depending on your network setup, there may be more than one accounting server. Also there may be a client (Network

Access Server or proxy server) that sends accounting request packets to the external Radius accounting server.

Enable Radius

The **Radius Mode** is “Off” by default. To use Radius, click the “On” radio button. This action displays the Radius Authentication Settings frame.

Specify Radius Authentication Settings

1. In the **Radius Server** field, *1.2.3.9* displays by default. Enter the IP address of the Radius accounting server.
2. In the **Radius Port** number field, *1813* displays by default. Change this number only if the Radius accounting server uses a different port number.
3. In the **Byte Order Mode** field, specify the format in which bytes will be transferred:
 - Click the radio button corresponding to **Network Byte Order** to transfer the most significant byte first.
 - Click the radio button corresponding to **Host Byte Order** to use the byte order stored in the server (big endian or little endian order).



NOTE: *The byte order should match the setting on the Radius accounting server.*

4. In the **Forward Mode** field, specify whether accounting request packets will be delivered from the client (NAS or proxy server) to the Radius accounting server.

To enable the Forward Mode option:

- Click the “On” radio button. The NAS will forward accounting request packets to the Radius accounting server.

- Check the box for **Use Web Filter IP as Source IP**, if the IP address of the Web Filter (LAN1 or LAN2) should be used when forwarding packets instead of the IP address of the NAS.

To disable the Forward Mode option, click the “Off” radio button. This action causes the **Use Web Filter IP as Source IP** field to display greyed out.

5. In the **Reply Mode** field, specify whether the server that sent a request should receive a response.

To enable the Reply Mode option:

- Click the “On” radio button. A reply and accounting response packet will be submitted to the sender (NAS or Radius server).
- Enter an **Authenticated Phrase** to be shared by the Radius server and NAS.
- At the **Copy Proxy State** field, click the “On” radio button if you wish to copy the proxy state attribute to the packet.



NOTE: *The copy proxy state attribute will only be added to the response packet if the Reply Mode is “On”. If the Radius accounting server is in the Forward Mode and the Reply Mode is “Off”, the copy proxy state attribute will be forwarded to the destination server but will not reply back to the client.*

Apply Settings

Click **Apply** to save your settings.

Disable Radius

To disable the Radius feature:

1. At the **Radius Mode** field, click the “Off” radio button.
2. Click **Apply**.

SNMP

SNMP window

The SNMP window displays when SNMP is selected from the navigation panel. This feature lets the global administrator use a third party Simple Network Management Protocol (SNMP) product for monitoring and managing the working status of the Web Filter's filtering on a network.

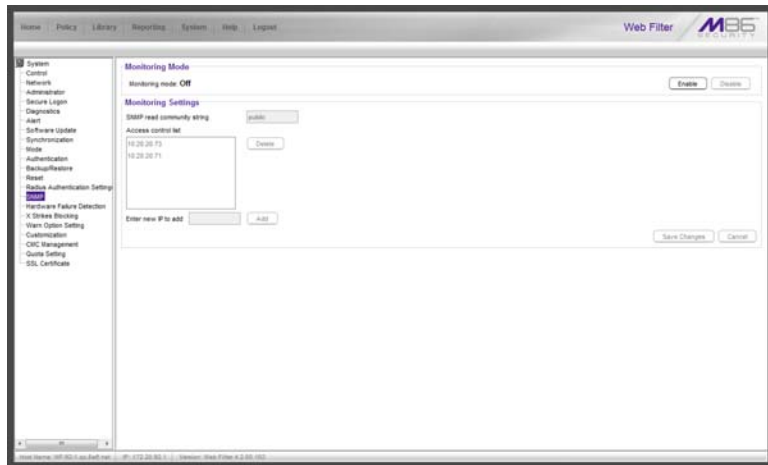

Fig. 2:1-63 SNMP window

The following aspects of the Web Filter are monitored by SNMP: data traffic sent/received by a NIC, CPU load average at a given time interval, amount of free disk space for each disk partition, time elapse since the box was last rebooted, and the amount of memory currently in usage.

Enable SNMP

The **Monitoring mode** is “Off” by default. To enable SNMP, click **Enable** in the Monitoring Mode frame. As a result, all elements in this window become activated.

Specify Monitoring Settings

Set up Community Token for Public Access

Enter the password to be used as the **Community token for public access**. This is the password that the management Web Filter console would use when requesting access.

Create, Build the Access Control List

1. In the **Enter new IP to add** field, enter the IP address of an interface from/to which the SNMP should receive/send data.
2. Click **Add** to include the entry in the Access control list box.

Repeat steps 1 and 2 for each IP address to be included in the list.

3. After all entries are made, click **Save Changes**.

Maintain the Access Control List

1. To remove one or more IP addresses from the list, select each IP address from the Access control list, using the **Ctrl** key for multiple selections.
2. Click **Delete**.
3. Click **Save Changes**.

Hardware Failure Detection

Hardware Failure Detection window

The Hardware Failure Detection window displays when Hardware Failure Detection is selected from the navigation panel. This feature shows the status of each drive on the RAID server.



Fig. 2:1-64 Hardware Failure Detection window, HL and SL models

View the Status of the Hard Drives

The Hardware Failure Detection window displays the current RAID Array Status for each of the hard drives (HD 1 and HD 2). If both hard drives are functioning without failure, the text “OK” displays to the right of the hard drive number, and no other text displays on the screen.

If any of the hard drives has failed, the message “FAIL” displays to the right of the hard drive number, and instructions for replacing the hard drive display below:

1. Identify the failed drive based on the information provided on the GUI

2. Replace the failed drive with your spare replacement drive
3. Click on the “Rebuild” button on the GUI
4. To return a failed drive to M86 or to order additional replacement drives, please call M86 Technical Support



NOTE: For information on troubleshooting RAID, refer to Appendix F: RAID and Hardware Maintenance.

X Strikes Blocking

X Strikes Blocking window

The X Strikes Blocking window displays when X Strikes Blocking is selected from the navigation panel. This feature lets a global administrator set criteria for blocking a user's access to “unacceptable” Internet sites and locking a user’s workstation, after the user makes a specified (“X”) number of attempts to such sites. “Unacceptable” Internet sites pertain to sites included in categories that are blocked in a user’s profile.

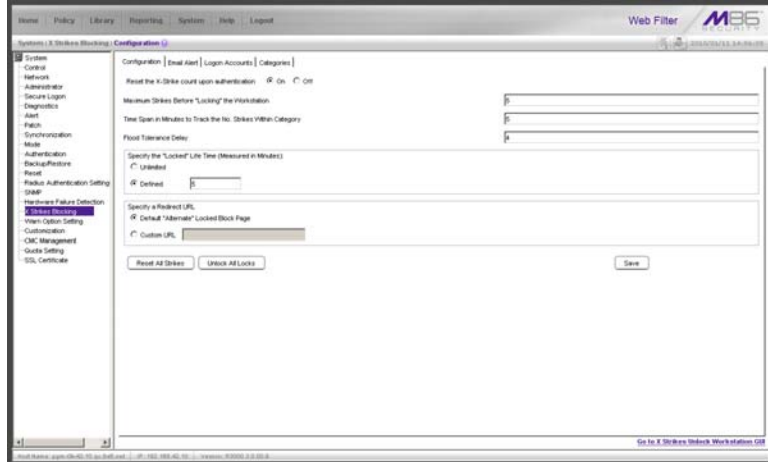

Fig. 2:1-65 X Strikes Blocking window, Configuration tab



NOTES: The X Strikes Blocking topic does not display if the synchronization feature is used, and this server being configured is set up in the Target mode to synchronize both profile and library setting changes.

X Strikes Blocking settings are effective only for filtering profiles with the X Strikes Blocking filter option enabled. (See Filter Options in the Policy screen section for information on setting up the X Strikes Blocking filter option.)

Configuration

Set up Blocking Criteria

1. At **Reset the X-Strike count upon authentication**, “Off” is selected by default. To have all strikes reset before an end user is authenticated, click “On”.
2. Enter the **Maximum Strikes Before “Locking” the Workstation**. This is the number of attempts a user can make to access an unacceptable site before that user is prevented from using the Internet. The default is 5, and the maximum limit is 1000.
3. Enter the **Time Span in Minutes to Track the No. of Strikes Within Category**. This is the amount of time between a given user's first strike and the strike that will lock out that user from his/her Internet access. The default setting is 5, and the maximum limit is 1440 minutes (24 hours).
4. Enter the number of seconds for the **Flood Tolerance Delay**, which is the maximum amount of time that will elapse before a user who accesses the same inappropriate URL will receive another strike. The default setting and the maximum limit is 4 seconds.
5. **Specify the “Locked” Life Time (Measured in Minutes)**, which is the number of minutes a user's workstation will be locked. Choose either “Unlimited”, or “Defined”.

If “Defined” is selected, enter the number of minutes in the text box. The default setting is 5.
6. **Specify a Redirect URL** to be used when the end user is locked out from his/her workstation. By default, “Default "Alternate" Locked Block Page” is selected, indicating that the standard lock out block page will display.

To specify a different page, click “Custom URL” and enter the URL in the text box.

7. Click **Save** to save your configuration settings.

Reset All Workstations

The following buttons can be clicked to reset workstations:

- Click **Reset All Strikes** to remove all strikes from all workstations, and to unlock all locked workstations.
- Click **Unlock All Locks** to remove locks on all locked workstations.

Lock Page

A user who receives the final strike that locks him/her out the workstation will see the following lock page display on the screen:

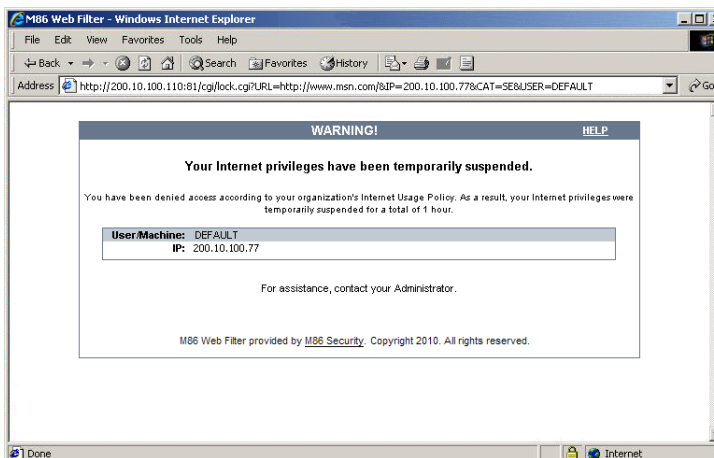

Fig. 2:1-66 Sample lock page

The text informs the user: “Your Internet privileges have been temporarily suspended. For assistance, contact your Administrator.”

The following information might also display in the lock page: “You have been denied access according to your organization's Internet Usage Policy. As a result, your Internet privileges were temporarily suspended for a total of ‘X’ (amount of time),” in which ‘X’ represents the number of minutes/hours the user will be locked out from Internet usage on that workstation.



NOTE: *This message may differ, depending on whether or not alternate text and settings were made in the Lock Page Customization window and the Common Customization window. (See Customization in this chapter for more information.)*

The user will not be able to access the Internet from that workstation until the Defined amount of time specified in the “Locked” Life Time field passes, or unless an authorized staff member manually unlocks that user’s workstation (see Go to X Strikes Unlock Workstation GUI in this section).

Overblocking or Underblocking



NOTES: *In order to prevent overblocking, unacceptable Internet images/links are allowed to pass by if they display within the four-second tolerance time range of a given strike. Thus, only one strike will count against a user who visits a Web page embedded with multiple, unacceptable images/links, if these images/links load within four seconds of that strike. Banners and IM/P2P sites included in the library are white listed and do not count as strikes.*

If users are receiving too many strikes or too few strikes within a given period of time, you may need to modify the configuration settings.

Sample Settings:

- Maximum strikes = **5**
- Time span for the maximum number of strikes = **5** minutes

Within a five-minute period, if a user accesses five sites that contain blocked material, that user will be locked out of his/

her workstation for five minutes. However, since the tolerance timer is set at four seconds, a user could potentially receive five strikes within 16 seconds if he/she accesses a page with multiple, inappropriate images and/or links that load on each page within four seconds. In this scenario, the first strike would be delivered at 0 seconds, the second at 4 seconds, the third at 8 seconds, the fourth at 12 seconds, and the fifth at 16 seconds.

If the configuration settings for this example overblock too many users too frequently:

- the time span for the maximum number of strikes may need to be increased
- the maximum number of strikes may need to be increased

If these configuration settings do not block users often enough

- the time span for the maximum number of strikes may need to be reduced
- the maximum number of strikes may need to be reduced

Email Alert

Click the Email Alert tab to display Email Alert:

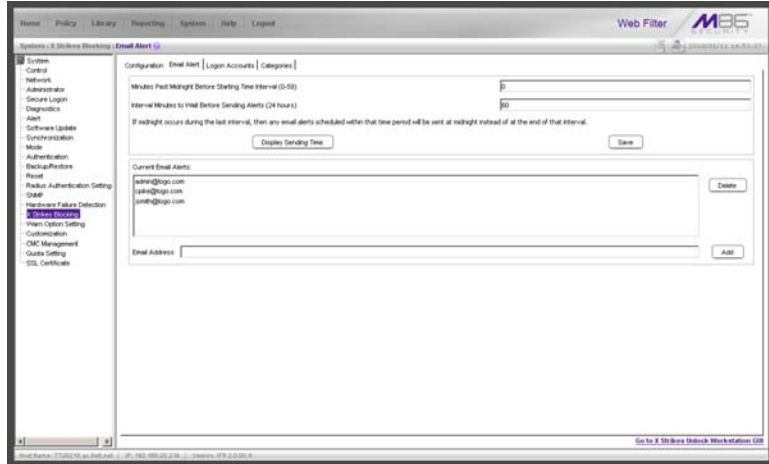

Fig. 2:1-67 X Strikes Blocking window, Email Alert tab

Set up Email Alert Criteria

1. In the **Minutes Past Midnight Before Starting Time Interval (0-59)** field, enter the number of minutes past midnight that a locked workstation email alert will first be sent to the specified recipient(s).
2. In the **Interval Minutes to Wait Before Sending Alerts (24 hours)** field, enter the number of minutes within the 24-hour period that should elapse between email alerts.

For example, by entering **300** in this field and **30** in the previous field, if there are any email alerts they will be sent at 5:30:00 AM, 10:30:00 AM, 3:30:00 PM, 8:30:00 PM, and at midnight when the time interval is reset.

To check the time(s) the email alert is scheduled to occur, click the **Display Sending Time** button to open The Daily Schedule pop-up window that shows the alert time schedule in the (HH:MM:SS) format:

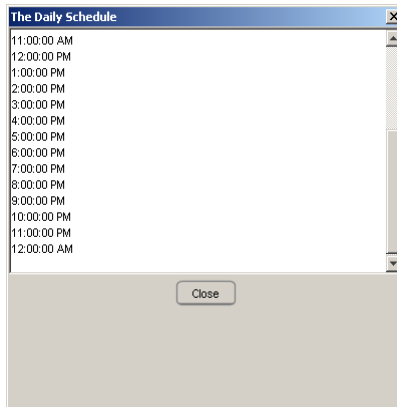

Fig. 2:1-68 The Daily Schedule pop-up window

Click **Close** to close the pop-up window.

3. Click **Save** to save the field entries.

Set up Email Alert Recipients

1. Enter the **Email Address** of an individual who will receive locked workstation email alerts.
2. Click **Add** to include the email address in the Current Email Alerts list box.



NOTE: *The maximum number of email alert recipients is 50. If more than 50 recipients need to be included, M86 recommends setting up an email alias list for group distribution.*

Remove Email Alert Recipients

1. Select the email address(es) from the Current Email Alerts list box.
2. Click **Delete** to remove the email address(es) from list.

Logon Accounts

Click the Logon Accounts tab to display Logon Accounts:

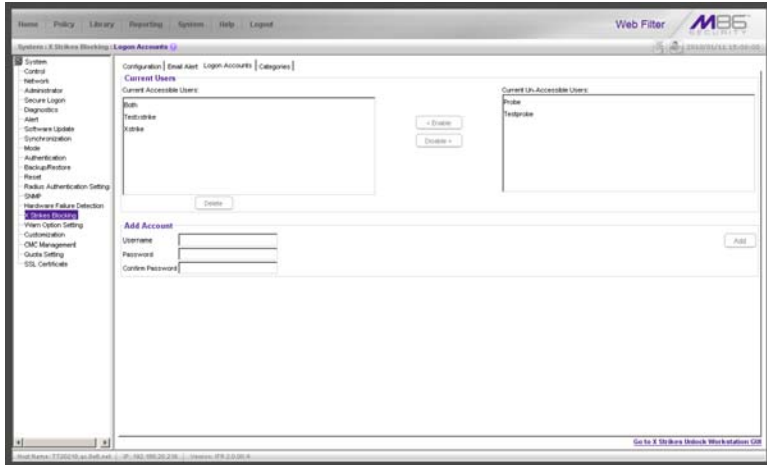

Fig. 2:1-69 X Strikes Blocking window, Logon Accounts tab

Set up Users Authorized to Unlock Workstations

1. Enter the **Username** of a staff member who is authorized to unlock workstations.
2. Enter the user's password in the **Password** and **Confirm Password** fields, using eight to 20 characters and at least one alpha character, one numeric character, and one special character. The password is case sensitive.
3. Click **Add** to include the username in the Current Accessible Users list box.



NOTE: When an authorized staff member is added to this list, that username is automatically added to the Current Un-Accessible Users list box in the Logon Accounts tab of the Real Time Probe window.

Deactivate an Authorized Logon Account

To deactivate an authorized user's account:

1. Select the username from the Current Accessible Users list box.
2. Click **Disable** to move the username to the Current Un-Accessible Users list box.

Delete a Logon Account

To delete a user's account:

1. Select the username from the Current Accessible Users list box.
2. Click **Delete**.



WARNING: *By deleting a logon account, in addition to not being able to unlock workstations, that user also will be removed from the list of users authorized to create real time probes. (See Chapter 4: Reporting screen, Real Time Probe for information on setting up and using real time probes.)*

Categories

Click the Categories tab to display Categories:

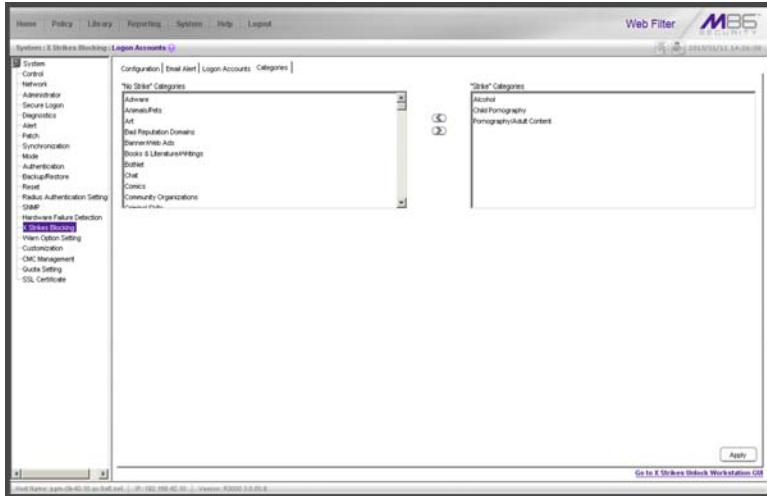



Fig. 2:1-70 X Strikes Blocking window, Categories tab

Set up Categories to Receive Strikes or No Strikes

1. Select library categories from the “No Strike” Categories list box.
2. Click the right arrow (>) to move the selected library categories to the “Strike” Categories list box.

 **TIP:** Use the left arrow (<) to move selected “Strike” Categories to the “No Strike” Categories list box.

3. Click **Apply** to apply your settings.

 **NOTE:** Library categories in the “Strike” Categories list box will only be effective for filtering profiles with the X Strikes Blocking Filter Option enabled.

Go to X Strikes Unlock Workstation GUI

When any administrator clicks the X Strikes Blocking  icon or **Go to X Strikes Unlock Workstation GUI**, either the Re-login window or the X Strikes Unlock Workstation pop-up window opens.

Re-login window

The Re-login window opens if the user's session needs to be validated:

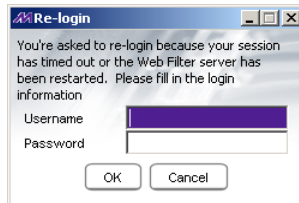

Fig. 2:1-71 Re-login window

1. Enter your **Username**.
2. Enter your **Password**.
3. Click **OK** to close the Re-login window and to re-access the Web Filter console.

X Strikes Unlock Workstation

The following information displays in the X Strikes Unlock Workstation pop-up window: IP Address, User Name, and Expire Date/Time of currently locked workstations.

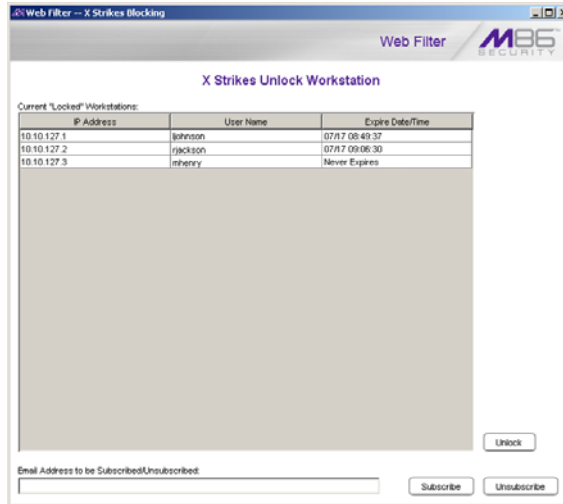

Fig. 2:1-72 X Strikes Unlock Workstation window

Unlock a Workstation

To unlock a specified workstation:

1. Select that workstation from the grid.
2. Click **Unlock**.



NOTE: An authorized staff member can click a link in an email alert, or type in <https://x.x.x.x:1443/XStrike.html> in the address field of a browser window—in which “x.x.x.x” is the IP address of the Web Filter—to view locked workstation criteria.

When using the aforementioned URL, the following occurs:

- The Login window opens:

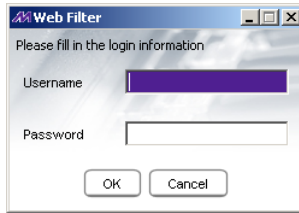

Fig. 2:1-73 Login window

Enter the Username and Password and click **OK** to open the X Strikes Unlock Workstation pop-up window (see Fig. 2:1-69).

- The Web Filter Introductory Window for X Strikes simultaneously opens with the Login window:

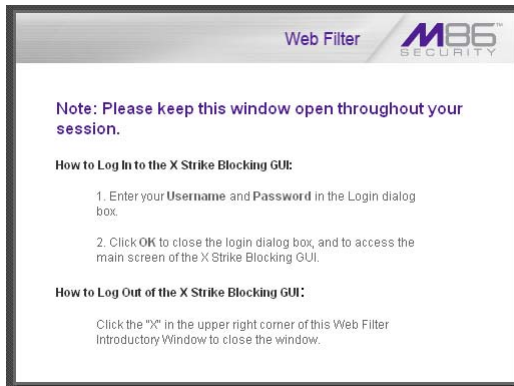

Fig. 2:1-74 X Strikes introductory window

This window must be left open during the entire session.

Set up an Email Address to Receive Alerts

To send locked workstation information to a designated administrator:

1. Enter the email address in the **Email Address to be Subscribed/Unsubscribed** text box.
2. Click **Subscribe**.

Remove an Email Address from the Alert List

To remove an administrator's email address from the notification list:

1. Enter the email address in the **Email Address to be Subscribed/Unsubscribed** text box.
2. Click **Unsubscribe**.

Close the Pop-up Window

Click the “X” in the upper right corner of the pop-up window to close the window.

Warn Option Setting

Warn Option Setting window

The Warn Option Setting window displays when Warn Option Setting is selected from the navigation panel. This feature lets a global administrator specify the number of minutes for the interval of time in which a warning page will redisplay for the end user who accesses a URL in a library category with a Warn setting for his/her profile. If the end user accesses another URL in a category with a Warn setting, the warning page displays again and will continue to redisplay for the interval of time specified, as long as the end user's browser is open to any URL with a Warn setting.

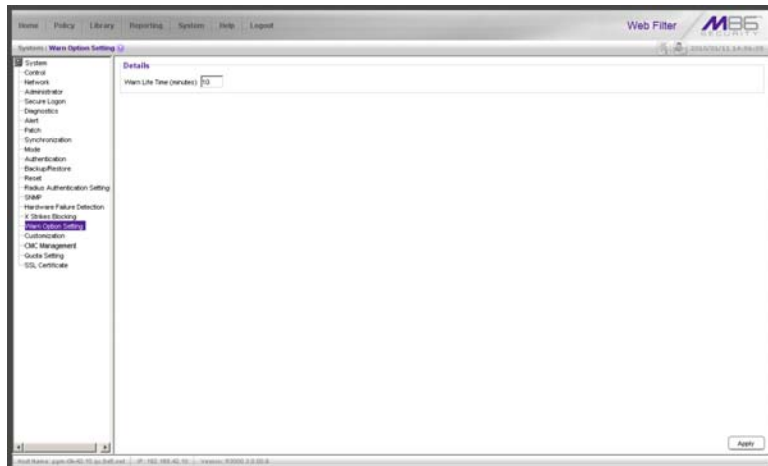

Fig. 2:1-75 Warn Option Setting window



NOTES: *If using the synchronization feature, the Warn Option Setting window is available in the Stand Alone and Source mode. This topic does not display if this server being configured is set up in the Target mode to synchronize both profile and library setting changes.*

See the Warn Page Customization window in this chapter for information on customizing text in the warning page that displays for end users.

Specify Interval for Re-displaying the Warn page

1. In the **Warn Life Time (minutes)** field, by default 10 displays. Enter the number of minutes (1-480) to be used in the interval for re-displaying the warning page for the end user.
2. Click **Apply** to enable your setting.

Customization

Customization includes options to customize settings for HTML pages that display for end users who execute a command that triggers the associated pop-up window to open. Click the Customization link to view a menu of sub-topics: Common Customization, Authentication Form, Lock Page, Block Page, Warn Page, Profile Control, Quota Block Page, Quota Notice Page.



NOTES: *All Customization windows display greyed-out if the synchronization feature is used, and this server being configured is set up in the Target mode to synchronize both profile and library setting changes.*

Refer to the M86 Web Filter Authentication User Guide for information on using the Authentication Form Customization window.

Common Customization window

The Common Customization window displays when Common Customization is selected from the Customization menu. This window is used for specifying elements to be included in block, lock, profile, and warning pages, and/or the authentication request form the end user will see.

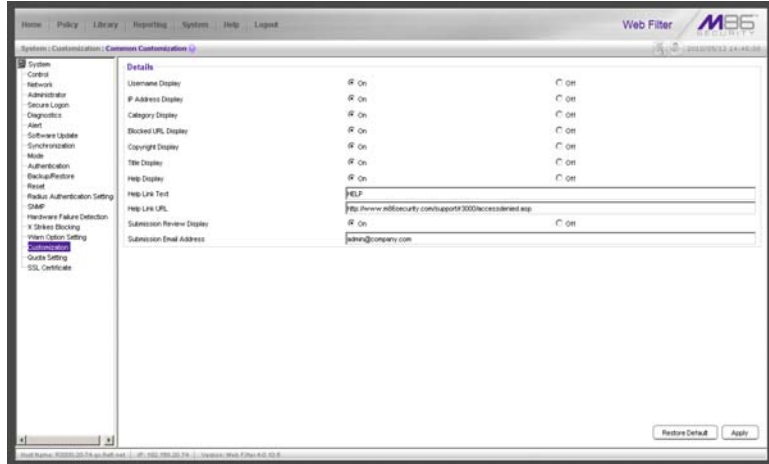

Fig. 2:1-76 Common Customization window

By default, in the Details frame all elements are selected to display in the HTML pages, the Help link points to the FAQs page on M86's public site that explains why access was denied, and a sample email address is included for administrator contact information. These details can be modified, as necessary.

Enable, Disable Features

1. Click “On” or “Off” to enable or disable the following elements in the HTML pages, and make entries in fields to display customized text, if necessary:
 - Username Display - if enabled, displays “User/ Machine” followed by the end user’s username in block and lock pages
 - IP Address Display - if enabled, displays “IP” followed by the end user’s IP address in block and lock pages
 - Category Display - if enabled, displays “Category” followed by the long name of the blocked category in block pages
 - Blocked URL Display - if enabled, displays “Blocked URL” followed by the blocked URL in block pages
 - Copyright Display - if enabled, displays M86 Web Filter copyright information at the footer of block and lock pages, and the authentication request form
 - Title Display - if enabled, displays the title of the page in the title bar of the block and lock pages, and the authentication request form
 - Help Display - if enabled, displays the specified help link text in block and lock pages, and the authentication request form. The associated URL (specified in the Help Link URL field described below) is accessible to the end user by clicking the help link.



NOTE: *If enabling the Help Display feature, both the Help Link Text and Help Link URL fields must be populated.*

- **Help Link Text** - By default, *HELP* displays as the help link text. Enter the text to display for the help link.

- **Help Link URL** - By default, *http://www.m86security.com/support/r3000/accessdenied.asp* displays as the help link URL. Enter the URL to be used when the end user clicks the help link text (specified in the Help Link Text field).
- **Submission Review Display** - if enabled, displays in block pages the email address of the administrator to receive requests for a review on sites the end users feel are incorrectly blocked. The associated email address (specified in the Submission Email Address field described below) is accessible to the end user by clicking the **click here** link.



NOTE: *If enabling the Submission Review Display feature, an email address entry of the designated administrator in your organization must be made in the Submission Email Address field.*

- **Submission Email Address** - By default, *admin@company.com* displays in block pages as the email address of the administrator to receive feedback on content the end user feels has been incorrectly blocked. Enter the global administrator's email address.

2. Click **Apply** to save your entries.



TIP: *Click **Restore Default** and then click **Apply** to revert to the default settings in this window.*

Lock Page Customization window

The Lock Page Customization displays when Lock Page is selected from the Customization menu. This window is used with the X Strikes Blocking feature, and lets you customize text in the lock page end users will see when attempting to access Internet content blocked for their profiles, and their workstations are currently locked. Entries saved in this window display in the customized lock page, if these features are also enabled in the Common Customization window, and the X Strikes Blocking feature is enabled.



NOTE: See X Strikes Blocking window in this chapter for information on using the X Strikes Blocking feature.

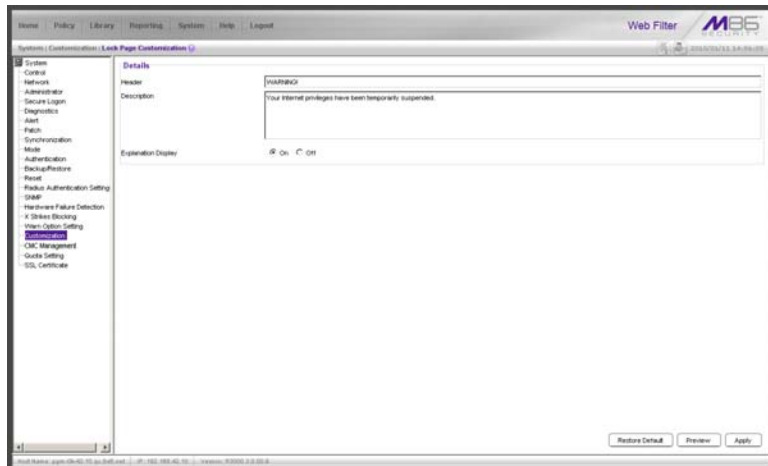

Fig. 2:1-77 Lock Page Customization window



TIP: An entry in any of the fields in this window is optional.

Edit Entries, Setting

1. Make an entry in any of the following fields:
 - In the **Header** field, enter a static header to be displayed at the top of the lock page.
 - In the **Description** field, enter a static text message to be displayed beneath the lock page header.

Any entries made in these fields will display centered in the customized lock page, using the Arial font type.

2. At the **Explanation Display** field, by default “On” is selected. This setting displays the reason the workstation is locked beneath the text from the Description field. Click “Off” to not have the explanatory text display in the lock page.
3. Click **Apply**.



TIP: Click **Restore Default** and then click **Apply** to revert to the default settings in this window.

Preview Sample Lock Page

1. Click **Preview** to launch a separate browser window containing a sample customized lock page, based on entries saved in this window and in the Common Customization window:

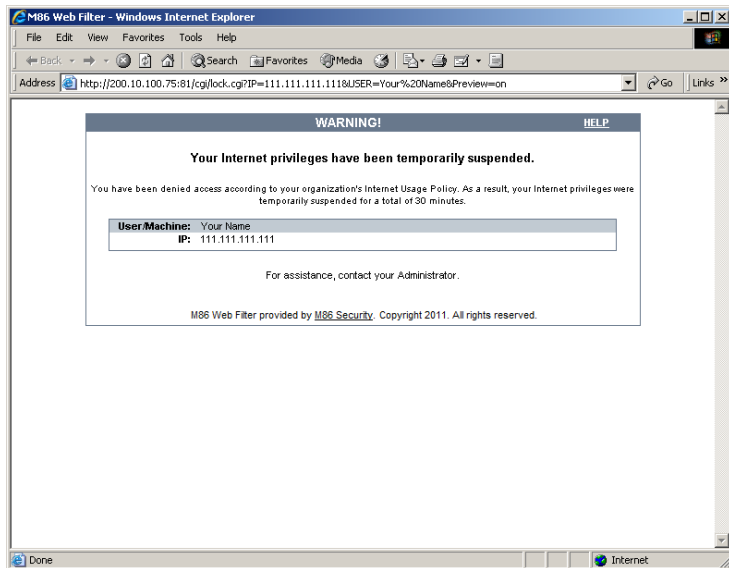

Fig. 2:1-78 Sample Customized Lock Page

By default, the following data displays in the User/Machine frame:

- **User/Machine** field - The username displays for the LDAP user. This field is blank for the IP group user.
- **IP** field - The user's IP address displays.

By default, the following standard links are included in the lock page:

- **HELP** - Clicking this link takes the user to M86's Technical Support page that explains why access to the site or service may have been denied.

- **M86 Security** - Clicking this link takes the user to M86's Web site.
2. Click the “X” in the upper right corner of the window to close the sample customized lock page.

 **TIP:** If necessary, make edits in the Lock Page Customization window or the Common Customization window, and then click **Preview** in this window again to view a sample lock page.

Block Page Customization window

The Block Page Customization window displays when Block Page Customization is selected from the Customization menu. This feature is used if you want to display customized text and include a customized link in the block page end users will see when attempting to access Internet content blocked for their profiles. Entries saved in this window display in the customized block page, if these features are also enabled in the Common Customization window.

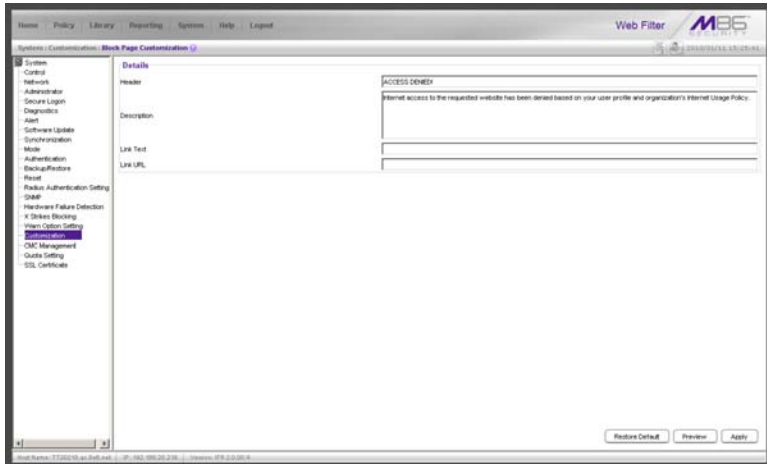



Fig. 2:1-79 Block Page Customization window

 **NOTE:** See Appendix B: Create a Custom Block Page for information on creating a customized block page using your own design.

 **TIP:** An entry in any of the fields in this window is optional, but if an entry is made in the *Link Text* field, a corresponding entry must also be made in the *Link URL* field.

Add, Edit Entries

1. Make an entry in any of the following fields:
 - In the **Header** field, enter a static header to be displayed at the top of the block page.
 - In the **Description** field, enter a static text message to be displayed beneath the block page header.
 - In the **Link Text** field, enter text for the link's URL, and in the **Link URL** field, enter the corresponding hyper-link in plain text using the *http://* or *https://* syntax.

Any entries made in these fields will display centered in the customized block page, using the Arial font type.

2. Click **Apply**.

 **TIP:** Click **Restore Default** and then click **Apply** to revert to the default settings in this window.

Preview Sample Block Page

1. Click **Preview** to launch a separate browser window containing a sample customized block page, based on entries saved in this window and in the Common Customization window:

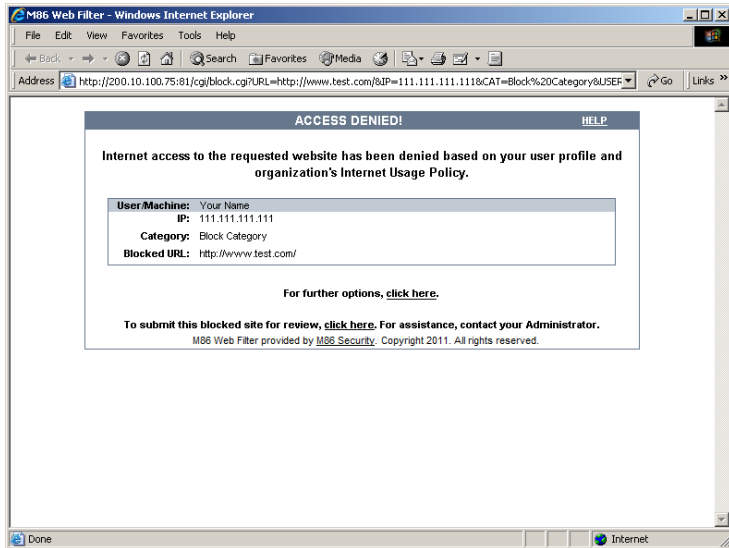

Fig. 2:1-80 Sample Customized Block Page

By default, the following data displays in the User/ Machine frame:

- **User/Machine** field - The username displays for the LDAP user. This field is blank for the IP group user.
- **IP** field - The user's IP address displays.
- **Category** field - The name of the library category that blocked the user's access to the URL displays. If the content the user attempted to access is blocked by an Exception URL, "Exception" displays instead of the library category name.
- **Blocked URL** field - The URL the user attempted to access displays.

By default, the following standard links are included in the block page:

- **HELP** - Clicking this link takes the user to M86's Technical Support page that explains why access to the site or service may have been denied.
- **M86 Security** - Clicking this link takes the user to M86's Web site.

By default, these links are included in the block page under the following conditions:

- **For further options, [click here](#)**. - This phrase and link is included if any option was selected at the Re-authentication Options field in the Block Page Authentication window. Clicking this link takes the user to the Options window.



NOTE: See the *Options page in the Block Page Authentication window sub-section for information on options that display in the Options window.*

- **To submit this blocked site for review, [click here](#)**. - This phrase and link is included if an email address was entered in the Submission Email Address field in the Common Customization window. Clicking this link launches the user's default email client. In the composition window, the email address from the Submission Email Address field populates the "To" field. The user's message is submitted to the global administrator.
2. Click the "X" in the upper right corner of the window to close the sample customized block page.



TIP: *If necessary, make edits in the Block Page Customization window or the Common Customization window, and then click **Preview** in this window again to view a sample block page.*

Warn Page Customization window

The Warn Page Customization window displays when Warn Page is selected from the Customization menu. This window is used with the Warn Option Setting feature, and lets you customize text in the pop-up window end users will see if attempting to access a URL in a library category set up with a Warn setting for his/her profile. Entries saved in this window display in the warning page, if these features are also enabled in the Common Customization window, and the Warn setting is applied to any library category or category group.



NOTE: See Warn Option Setting window in this chapter for more information about this feature.

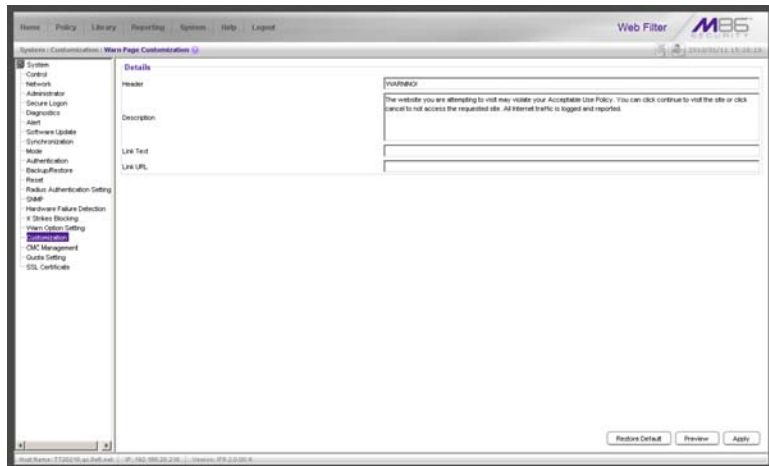

Fig. 2:1-81 Warn Page Customization window



TIP: An entry in any of the fields in this window is optional.

Add, Edit Entries

1. Make an entry in any of the following fields:
 - In the **Header** field, enter a static header to be displayed at the top of the warning page.
 - In the **Description** field, enter a static text message to be displayed beneath the warning page header.
 - In the **Link Text** field, enter text for the link's URL, and in the **Link URL** field, enter the corresponding hyper-link in plain text using the *http://* or *https://* syntax.

Any entries made in these fields will display centered in the customized warning page, using the Arial font type.

2. Click **Apply**.



TIP: Click **Restore Default** and then click **Apply** to revert to the default settings in this window.

Preview Sample Warning Page

1. Click **Preview** to launch a separate browser window containing a sample customized warning page, based on entries saved in this window and in the Common Customization window:

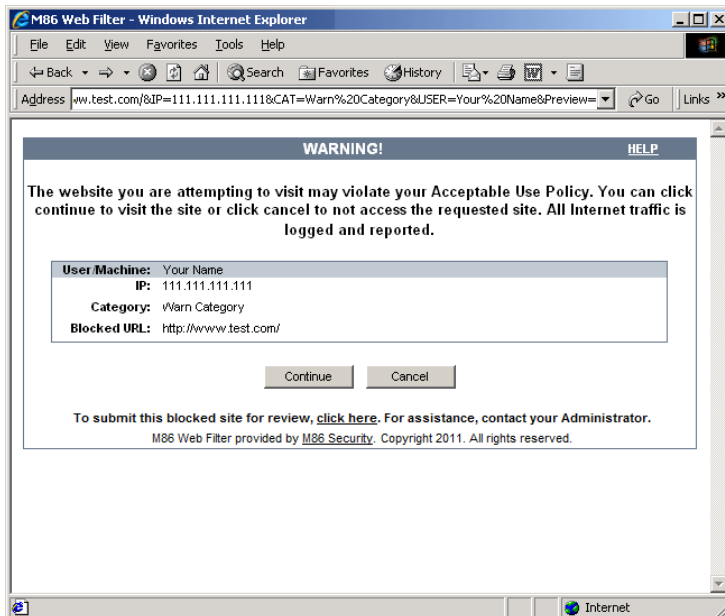

Fig. 2:1-82 Sample Customized Warning Page

By default, the following data displays in the User/ Machine frame:

- **User/Machine** field - The username displays for the LDAP user. This field is blank for the IP group user.
- **IP** field - The user's IP address displays.
- **Category** field - The name of the library category that warned the user about accessing the URL displays.
- **Blocked URL** field - The URL the user attempted to access displays.

By default, the following standard links are included in the warning page:

- **HELP** - Clicking this link takes the user to M86's Technical Support page that explains why access to the site or service may have been denied.
- **M86 Security** - Clicking this link takes the user to M86's Web site.

The following buttons are included in the warning page:

- **Continue** - Clicking this button closes the warning page and takes the user to the URL he/she requested. The number of minutes specified in the Warn Option Setting window determines when/if this warning page will redisplay for the user. If the user has his/her browser open to that URL for the number of minutes—or more—specified for the time interval, this warning page will redisplay, and the user must click this button once more in order to continue accessing the URL.



NOTE: *If using the Real Time Probe feature, in the Real Time Information box the Filter Action column displays “Warn” for the first time the user saw the warning window and clicked Continue, and “Warned” for each subsequent time the warning window opened for the user and he/she clicked Continue.*

- **Cancel** - Clicking this button returns the user to the previous URL.

By default, this link is included in the warning page under the following conditions:

- **To submit this warned site for review, [click here](#).** - This phrase and link is included if an email address was entered in the Submission Email Address field in the Common Customization window. Clicking this link launches the user's default email client. In the composition window, the email address from the Submission Email Address field populates the “To” field. The user's message is submitted to the global administrator.

2. Click the “X” in the upper right corner of the window to close the sample customized warning page.

 **TIP:** If necessary, make edits in the Warn Page Customization window or the Common Customization window, and then click **Preview** in this window again to view a sample warning page.

Profile Control window

The Profile Control window displays when Profile Control is selected from the Customization menu. This window is used with the Override Account feature, and lets you customize text in the pop-up window end users with override accounts will see when logging into their override accounts. Such accounts give authorized users access to Internet content blocked for other end users. Entries saved in this window display in the profile control pop-up window, if these features are also enabled in the Common Customization window, and override accounts are set up for designated end users.

 **NOTE:** See *Override Account window in the Policy section* for more information about this feature.

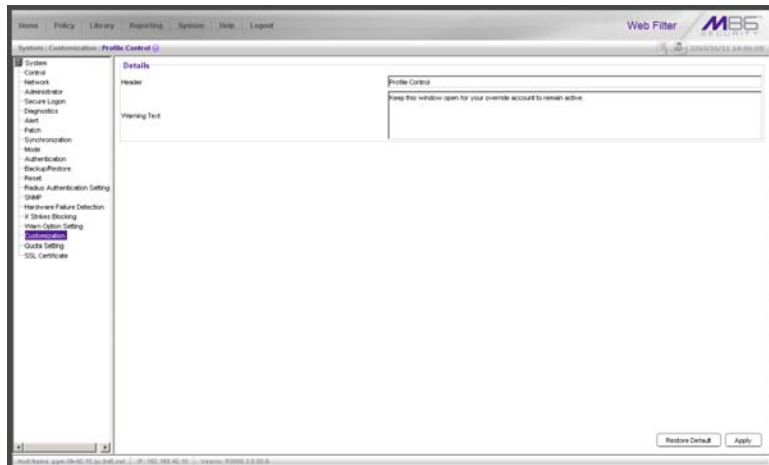





Fig. 2:1-83 Profile Control window

 **TIP:** An entry in any of the fields in this window is optional.

Edit Entries

1. Make an entry in any of the following fields:
 - In the **Header** field, enter a static header to be displayed at the top of the profile control pop-up window.
 - In the **Warning Text** field, enter a static text message to be displayed at the bottom of the pop-up window.
2. Click **Apply**.

 **TIP:** Click **Restore Default** and then click **Apply** to revert to the default settings in this window.

 **NOTE:** For a sample profile control pop-up window, see Option 3 from the Options page section of the Block Page Authentication window.

Quota Block Page Customization window

The Quota Block Page Customization window displays when Quota Block Page is selected from the Customization menu. This window is used for making customizations to the quota block page the end user will see if he/she has a quota time limit set for a passed category in his/her profile and has attained or exceeded that limit.

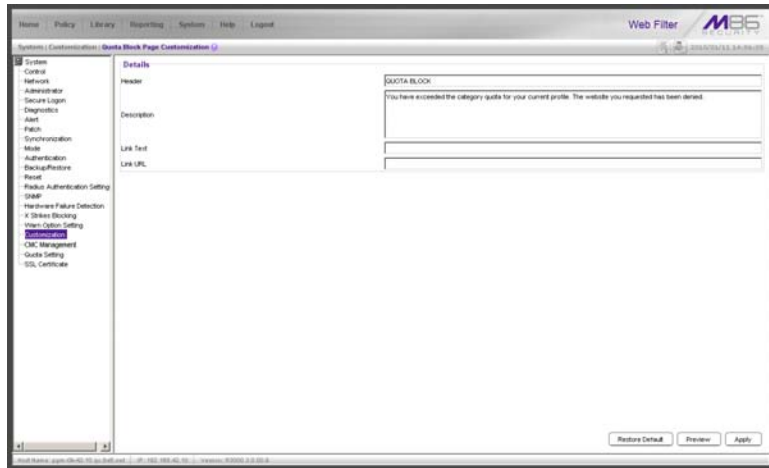

Fig. 2:1-84 Quota Block Page Customization window



TIP: An entry in any of the fields in this window is optional.



NOTE: For more information about quotas, see the Quota Setting window in this chapter.

Add, Edit Entries

1. Make an entry in any of the following fields:
 - In the **Header** field, enter a static header to display at the top of the quota block page.
 - In the **Description** field, enter a static text message to be displayed beneath the header.

- In the **Link Text** field, enter text for the link's URL, and in the **Link URL** field, enter the corresponding hyper-link in plain text using the *http://* or *https://* syntax.

Any entries made in these fields will display centered in the customized quota block page, using the Arial font type.

2. Click **Apply**.

 **TIP:** Click **Restore Default** and then click **Apply** to revert to the default settings in this window.

Preview Sample Quota Block Page

1. Click **Preview** to launch a separate browser window containing a sample customized quota block page, based on entries saved in this window and in the Common Customization window:

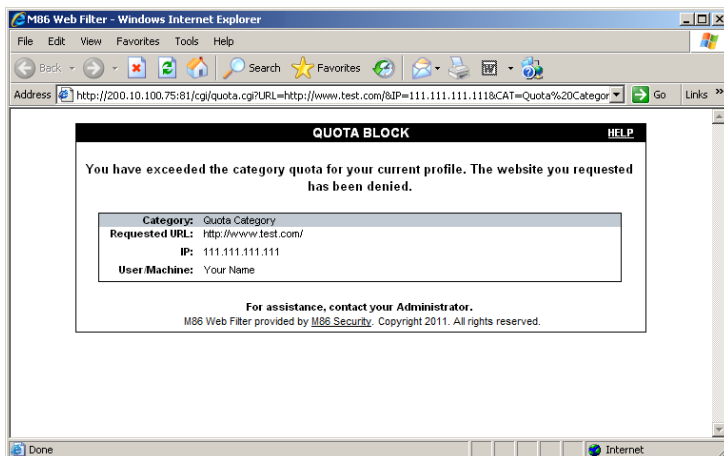

Fig. 2:1-85 Sample Customized Quota Block Page

By default, the following data displays in the Category frame:

- **Category** field - The name of the library category that blocked the user from accessing the URL displays.

- **Requested URL** field - The URL the user attempted to access displays.
- **IP** field - The user's IP address displays.
- **User/Machine** field - The username displays for the LDAP user. This field is blank for the IP group user.

By default, the following standard links are included in the quota block page:

- **HELP** - Clicking this link takes the user to M86's Technical Support page that explains why access to the site or service may have been denied.
- **M86 Security** - Clicking this link takes the user to M86's Web site.

2. Click the "X" in the upper right corner of the window to close the sample customized quota block page.



TIP: *If necessary, make edits in the Quota Block Page Customization window or the Common Customization window, and then click **Preview** in this window again to view a sample quota block page.*

Quota Notice Page Customization window

The Quota Notice Page Customization window displays when Quota Notice Page is selected from the Customization menu. This window is used for making customizations to the quota notice page the end user will see if he/she has a quota time limit set for a passed category in his/her profile and has used 75 percent of the allotted time in that category.

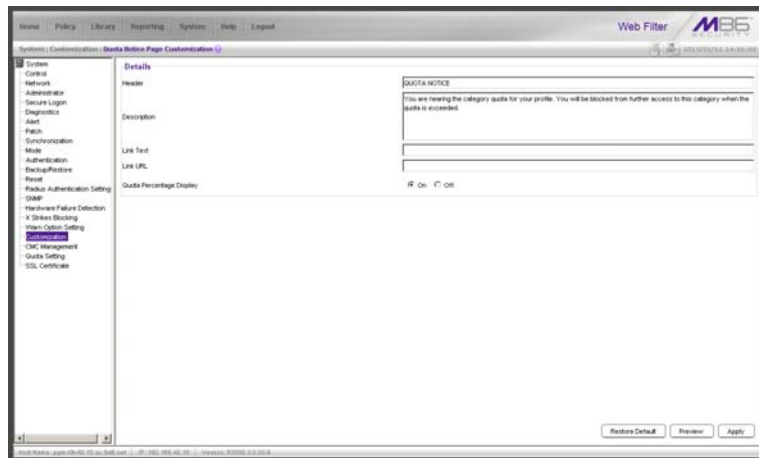

Fig. 2:1-86 Quota Notice Page Customization window



TIP: An entry in any of the fields in this window is optional.



NOTE: For more information about quotas, see the Quota Setting window in this chapter.

Add, Edit Entries

1. Make an entry in any of the following fields:
 - In the **Header** field, enter a static header to display at the top of the quota notice page.
 - In the **Description** field, enter a static text message to be displayed beneath the header.

- In the **Link Text** field, enter text for the link's URL, and in the **Link URL** field, enter the corresponding hyper-link in plain text using the *http://* or *https://* syntax.

Any entries made in these fields will display centered in the customized quota notice page, using the Arial font type.

2. By default, the **Quota Percentage Display** is enabled, indicating the percentage of quota used by the individual will display in the quota notice page. Click “Off” to not display this information in the quota notice page.
3. Click **Apply**.

 **TIP:** Click **Restore Default** and then click **Apply** to revert to the default settings in this window.

Preview Sample Quota Notice Page

1. Click **Preview** to launch a separate browser window containing a sample customized quota notice page, based on entries saved in this window and in the Common Customization window:

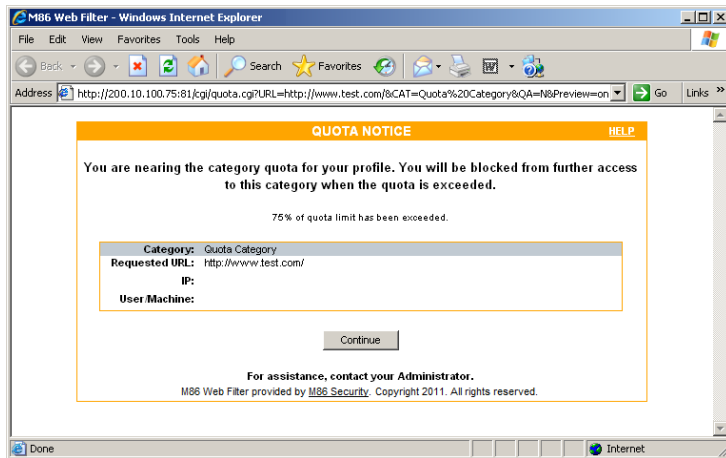

Fig. 2:1-87 Sample Customized Quota Notice Page

By default, the following data displays in the Category frame:

- **Category** field - The name of the library category containing a URL the user accessed—that triggered the quota notice—displays.
- **Requested URL** field - The URL the user accessed—that triggered the quota notice—displays.
- **IP** field - The user's IP address displays.
- **User/Machine** field - The username displays for the LDAP user. This field is blank for the IP group user.

By default, the following standard links are included in the quota notice page:

- **HELP** - Clicking this link takes the user to M86's Technical Support page that explains why access to the site or service may have been denied.
- **M86 Security** - Clicking this link takes the user to M86's Web site.

The following button is included in the quota notice page:

- **Continue** - Clicking this button closes the quota notice page and takes the user to the URL he/she requested.

2. Click the "X" in the upper right corner of the window to close the sample customized quota notice page.



TIP: *If necessary, make edits in the Quota Block Page Customization window or the Common Customization window, and then click **Preview** in this window again to view a sample quota block page.*

CMC Management

CMC Management displays on a Web Filter set up in the Source mode, and includes Centralized Management Console options for viewing the filtering statuses of this source server and its target server(s), and managing software updates on these servers.

Software Update Management window

The Software Update Management window displays when Software Update Management is selected from the CMC Management menu. This window is used for viewing software updates currently applied to the source and target servers and any available software updates, and applying software updates to these servers.

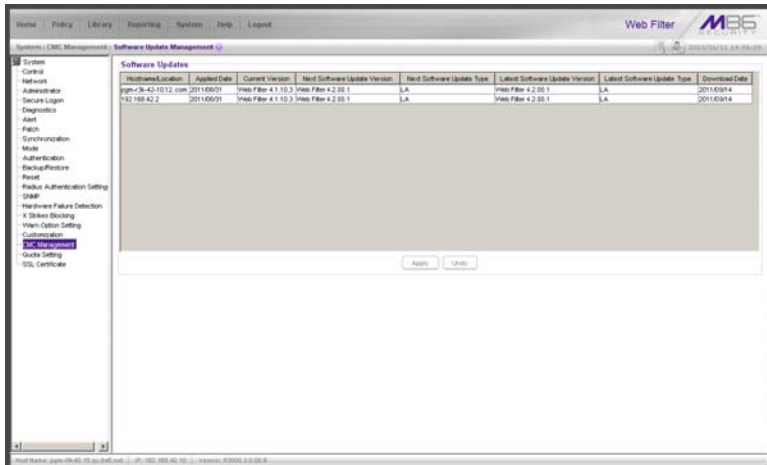

Fig. 2:1-88 Software Update Management window

View Software Update Information

The Software Updates frame displays the software update statuses of the source and each target Web Filter: Host-name/Location (information entered in the LAN Settings

window for the source server's hostname, or the information entered for the target server in the Target Location field in the Setup window); Applied Date (date the software update was applied to the server, using the YYYY/MM/DD format); Current Version (software update build name and number); Next Software Update Version (name and number of the next software update to be applied, or “N/A” if none is available); Next Software Update Type (“GA”, or “LA” or “Beta” if downloads for these software update types are enabled in the Local Software Update window, or “N/A” if no new software update is available); Latest Software Update Version (name and number of the latest software update, or “N/A” if none is available); Latest Software Update Type (“GA”, or “LA” or “Beta” if downloads for these software update types are enabled in the Local Software Update window, or “N/A” if no new software update is available); Download Date (date the latest software update was downloaded to the server, or N/A if none is available).



NOTE: *Definitions for Software Update Types (GA, LA, and Beta) are provided in the Enable/Disable Software Update Type Download frame at the bottom of the Local Software Update window. General Availability (GA) software updates are supplied to all active Web Filter units. Limited Availability (LA) and/or Beta software updates are available to Web Filter units that have the checkbox enabled for LA and/or Beta software updates.*



TIPS: *The entire grid can be viewed by using the scroll bar at the bottom of the Software Updates frame to scroll to the right and left.*

The order in which columns display in the grid can be changed by clicking the column header and sliding the column to another position in the grid.

Columns can be resized by mousing over the line in the header between two columns so that a double-ended arrow (<—>) displays, and then clicking and dragging the cursor to the left or right.

Apply or Undo a Software Update

To apply a software update:

1. Click to select the row(s) corresponding to the servers to be updated.
2. Click **Apply**.



NOTES: *If the source server is selected for a software update, the EULA displays when the software update is about to be applied. See the sub-section for the Local Software Updates window for information about the EULA and applying software updates.*

Only a software update number that is lesser to, or equal to, the source server's software update number can be applied to a target server.



TIP: *Multiple target servers can be selected to have a software update applied, if these target servers are currently running the same software version number.*

To undo a software update:

1. Select the row(s) corresponding to the server(s) that need(s) to have the last software update removed.
2. Clicking **Undo** to remove that software update from the server(s).

Status window

The Status window displays when Status is selected from the CMC Management menu. This window is used for viewing the filtering status of the source and target server(s) for troubleshooting purposes.

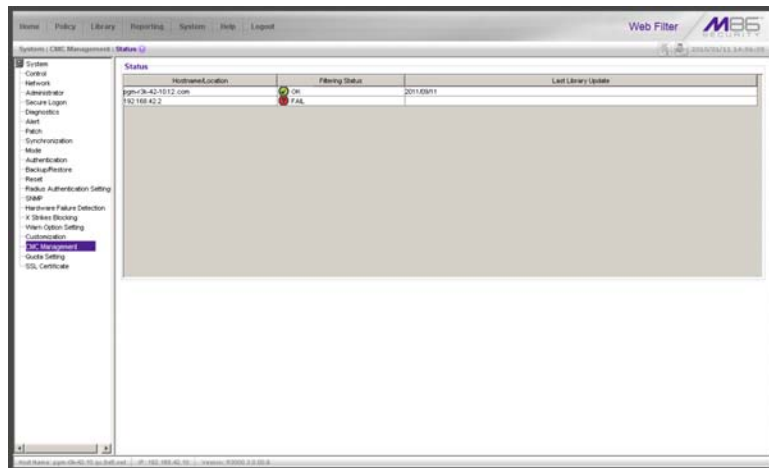

Fig. 2:1-89 Status window, CMC Management menu

View Filtering Status Information

The Status frame displays the following columns of information:

- Hostname/Location - criteria entered in the LAN Settings window for the source server's hostname, or the information entered for the target server in the Target Location field of the Setup window
- Filtering Status - "OK" displays if the server is being filtered, or "FAIL" displays if the server is not being filtered



NOTE: Filtering Status information will only display if the "Upstream Failover Detect" option is enabled in the Synchronization > Setup window.

- Last Library Update - most recent date the library was updated on the server, using the YYYY/MM/DD format, if this information is available.



TIPS: *The order in which columns display in the grid can be changed by clicking the column header and sliding the column to another position in the grid.*

Columns can be resized by mousing over the line in the header between two columns so that a double-ended arrow (<—>) displays, and then clicking and dragging the cursor to the left or right.

Quota Setting

Quota Setting window

The Quota Setting window displays when Quota Setting is selected from the navigation panel. This window lets a global administrator configure URL hits that—along with quotas specified in filtering profiles—determine when a user will be blocked from further accessing URLs in a library group/category. This window is also used for resetting quotas so that users who have maxed-out their quota time will regain access to a library group/category with a quota time limit.

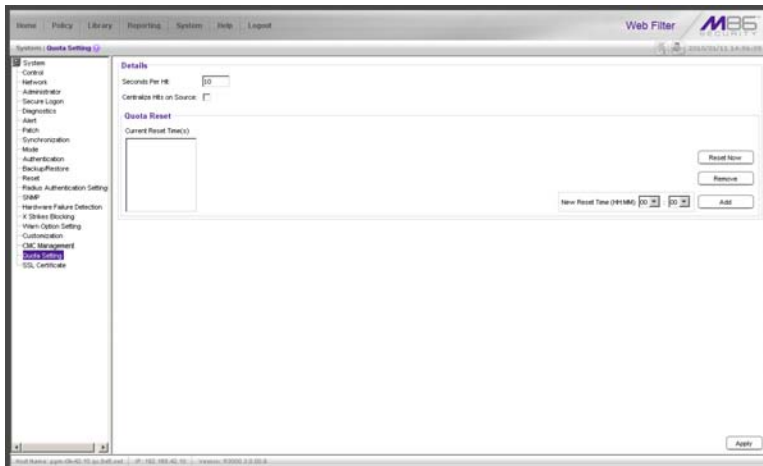

Fig. 2:1-90 Quota Setting window



TIP: After making all configuration settings in this window during this session, click **Apply**.

Configure Quota Hit Settings

1. Enter the number of **Seconds Per Hit** to indicate how much time will be applied towards a “hit” (URL access) in any category with a quota. The default is *10* seconds per hit. The entry in this field combines with the minutes entered in the quota from the filtering profile to determine the amount of time the end user can access URLs in the specified passed library group/category in that profile.

A quota can be set for an amount of time ranging from one minute to 1439 minutes (one day minus one minute). A hit can be set for an amount of time ranging from one second to 3600 seconds (one hour).

As an example of how a quota works in conjunction with hits, if a quota is set to 10 minutes and the number of seconds per hit is set to 10 seconds, then the user will be blocked from accessing URLs in the library group/category when 60 hits are made to that category—i.e. 600 seconds (10 minutes) divided by 10 seconds.



NOTE: This field is greyed-out if the Web Filter is set up as a target server in the synchronization mode.

2. If this Web Filter is set up with synchronization and is a source server, enable **Centralize Hits on Source** only if all hits should be made on this Web Filter.



NOTE: This field is greyed-out on a Web Filter set up as either a standalone server or as target server in the synchronization mode.



TIP: After making all configuration settings in this window during this session, click **Apply**.

Reset Quotas

Quotas are automatically reset at midnight, but also can be manually reset on demand or scheduled to be reset at specific times each day.

Reset Quotas Now

Click **Reset Now** to reset all quotas to zero (“0”). Users currently blocked from accessing URLs because of a quota time limit will now be able to access URLs in any library/group category with a quota.

Set up a Schedule to Automatically Reset Quotas

A schedule can be set up to reset all quotas at the appointed hour(s) / minute(s) each day.

1. At the **New Reset Time (HH:MM)** field:
 - Select the hour at which the quota will be reset (“00” - “23”)
 - Select the minute at which the quota will be reset (“00” - “59”)
2. Click **Add** to include this reset time in the Current Reset Time(s) list box.



TIP: Repeat steps 1 and 2 for each quota reset time to be scheduled. After making all configuration settings in this window during this session, click **Apply**.

Delete a Quota Reset Time from the Schedule

1. Select the quota reset time from the Current Reset Time(s) list box.
2. Click **Remove** to remove the quota reset time from the list box.

 **TIP:** After making all configuration settings in this window during this session, click **Apply**.

Quota Notice page

When the end user has spent 75 percent of time in a quota-restricted library group/category, the quota notice page displays:

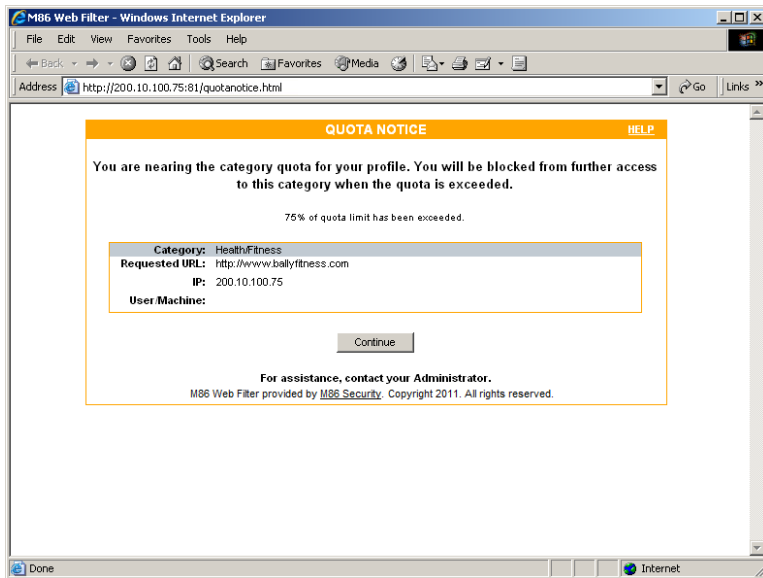

Fig. 2:1-91 Sample Quota Notice Page

By default, the following fields display:

- **Category** field - Name of the library category with the most hits.

- **Requested URL** field - The URL that triggered the Quota Notice page.
- **IP** field - The end user's IP address.
- **User/Machine** field - The username displays for the LDAP user. This field is blank for the IP group user.

By default, the following standard links are included in the quota notice page:

- **HELP** - Clicking this link takes the user to M86's Technical Support page that explains why access to the site may have been denied.
- **M86 Security** - Clicking this link takes the user to M86's Web site.

The end user can decide whether or not to access the requested URL. By clicking **Continue**, the user is redirected to the original requested site.

Quota Block page

When the end user has spent 100 percent of time in a quota-restricted library group/category, the quota block page displays:

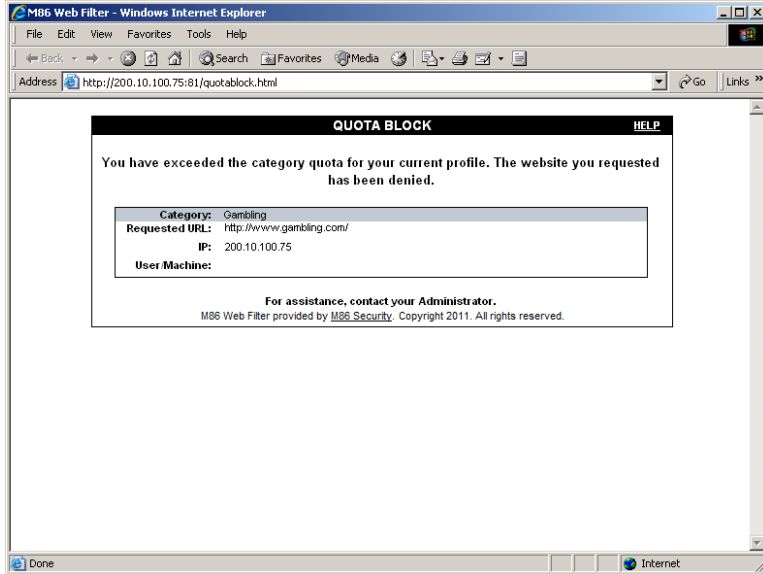

Fig. 2:1-92 Sample Quota Block Page

Once receiving a quota block page, the end user will not be able to access content in that library group/category until the quota is reset.

By default, the following fields display:

- **Category** field - The name of the library category that triggered the quota block page displays.
- **Requested URL** field - The URL the user attempted to access displays.
- **IP** field - The user's IP address displays.
- **User/Machine** field - The username displays for the LDAP user. This field may be blank for the IP group user.

By default, the following standard links are included in the quota block page:

- **HELP** - Clicking this link takes the user to M86's Technical Support page that explains why access to the site or service may have been denied.
- **M86 Security** - Clicking this link takes the user to M86's Web site.

SSL Certificate

SSL Certificate window

The SSL Certificate window displays when SSL Certificate is selected from the navigation panel. This window is used for generating a Secure Sockets Layer certificate that ensures secure exchanges between the Web Filter server and your browser.



Fig. 2:1-93 SSL Certificate window

Generate an SSL Certificate for the Web Filter

1. Click **Generate SSL Certificate** to open the pop-up box that asks if you wish to continue, which would restart your server.



TIP: Click **No** to close the pop-up window and to return to SSL Certificate window.

2. Click **Yes** to generate the SSL certificate and restart the Web Filter.
3. After the certificate is generated, you will be prompted to click **OK** and close your browser. Wait a few minutes before attempting to access the user interface.

Chapter 2: Policy screen

The Policy screen is comprised of windows and dialog boxes used for adding IP groups and/or LDAP domains, and for creating filtering profiles for IP/LDAP groups and their members.

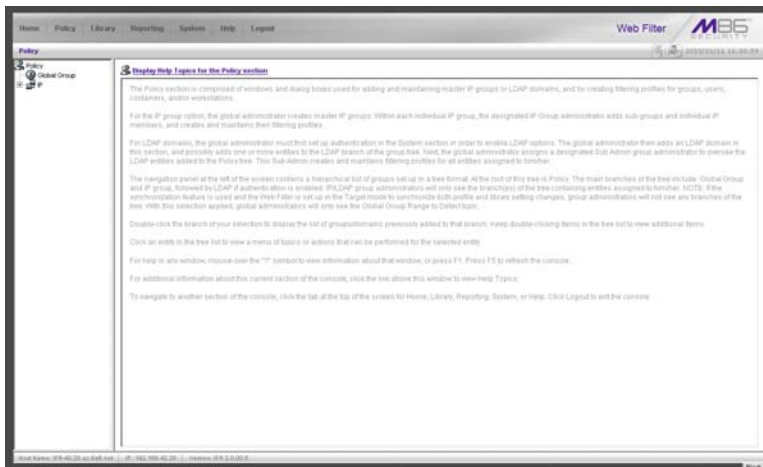

Fig. 2:2-1 Policy screen

For the IP group branch, the global administrator creates master IP groups. For each master IP group, the designated group administrator creates sub-groups and individual IP members, and adds and maintains their filtering profiles.

For the LDAP domain branch, the global administrator must first set up authentication in order to enable the LDAP branch(es). For each domain, the administrator then sets up and maintains groups, and creates filtering profiles for groups and users.

The navigation panel at the left of the screen contains a hierarchical list of groups set up in a tree format. At the root of this tree is Policy. The main branches of this tree include: Global Group and IP, followed by LDAP if authentication is enabled.

Double-click the branch of your selection to display the list of groups/domains previously added to that branch. Keep double-clicking items in the tree list to view additional items.

Click an entity in the tree list to view a menu of topics or actions that can be performed for that entity.



NOTES: *Information on LDAP groups can be found in the M86 Web Filter Authentication User Guide.*

Information on creating filtering profiles for IP groups can be found in the Group Administrator Section of this user guide.

If using the synchronization feature, if the Web Filter being configured is set up in the Target mode to synchronize both profile and library setting changes, the only branch that displays in the tree is Global Group.

Global Group

Global Group includes options for creating and maintaining groups. Click the Global Group link to view a menu of sub-topics: Range to Detect, Rules, Global Group Profile, Override Account, Approved Content (incl. VuSafe), Minimum Filtering Level, and Refresh All.



NOTE: If the synchronization feature is used and this Web Filter being configured is set up in the Target mode to synchronize both profile and library setting changes, the only sub-topic that displays is Range to Detect.

Range to Detect window

The Range to Detect window displays when Range to Detect is selected from the Global Group menu. This window is used for defining segments of network traffic to be detected by the Web Filter in the invisible or router mode. Service ports that should be open—ignored by the Web Filter—are also defined in this window.

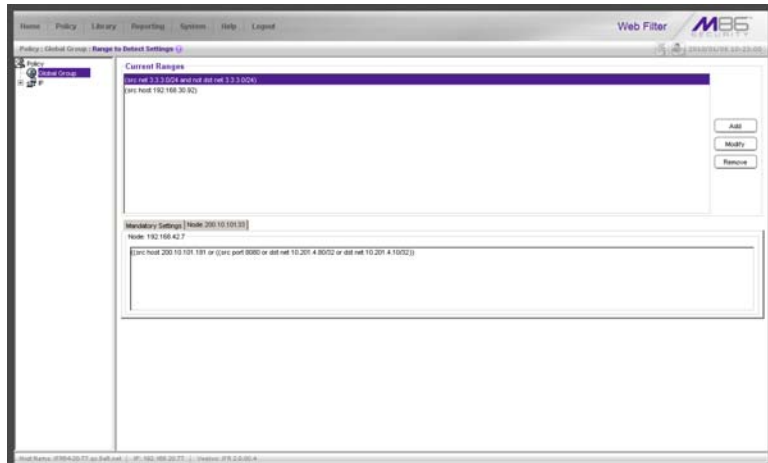



Fig. 2:2-2 Range to Detect Settings window, main window

 **NOTE:** Segments of network traffic should not be defined if using the firewall mode.

The main window (Fig. 2:2-2) lets you add segments to the network, or modify or remove existing segments. The Current Ranges list box includes a list of segments previously added using this feature. The Mandatory Settings tab provides examples of settings that can be made.

 **NOTE:** If this Web Filter is using the Source mode and the Upstream Failover Detect feature is enabled, if a downstream target server fails—as detected by the Appliance Watchdog—the Current Ranges information from the failed downstream target “node” displays in a Node tab following the Mandatory Settings tab in this window:

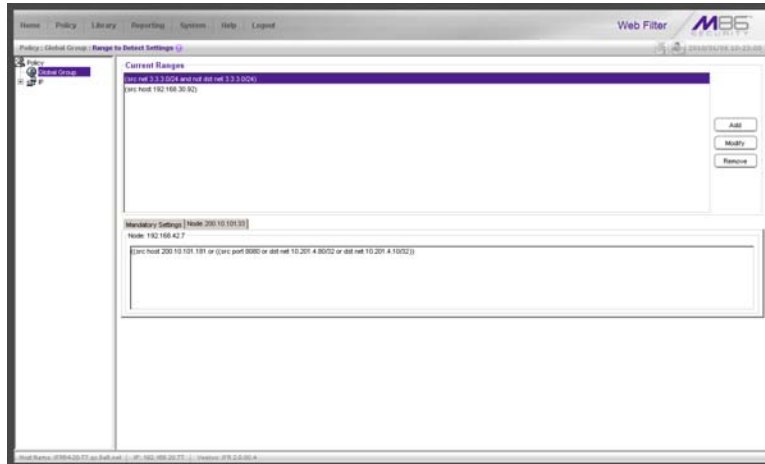

Fig. 2:2-3 Range to Detect Settings window, Node tab

Add a Segment to the Network

To add a segment to be detected on the network:

1. Click **Add** to go to the next page:

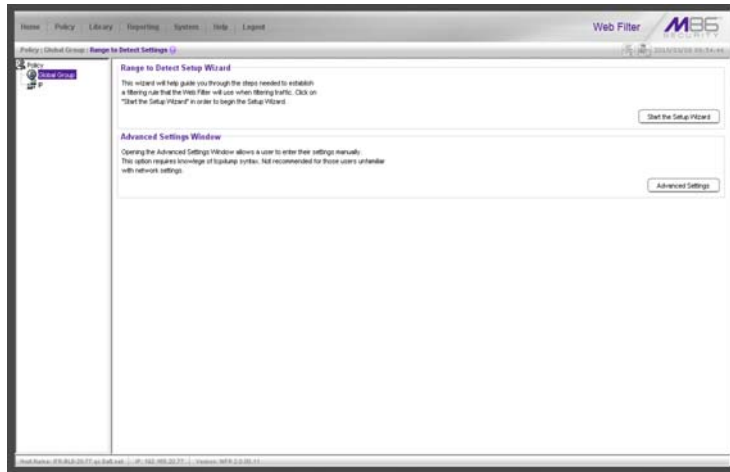

Fig. 2:2-4 Range to Detect Settings, second window

2. Click one of the following buttons to select the procedure for adding the segment:
 - **Start the Setup Wizard** - clicking this button takes you to the Range to Detect Setup Wizard. Follow the instructions in the Range to Detect Setup Wizard sub-section to complete the addition of the segment on the network.
 - **Advanced Settings** - clicking this button takes you to the Range to Detect Advanced Settings window. Follow the instructions in the Range to Detect Advanced Settings sub-section to complete the addition of the segment on the network.

Range to Detect Setup Wizard

Click the **Start the Setup Wizard** button to display Step 1 of the Range to Detect Setup Wizard. The Wizard is comprised of six steps. An entry is required in Step 1, but not in Steps 2 - 5. Settings made using the Wizard are saved in Step 6.

Step 1

In this step you define the source IP address(es) to be filtered.

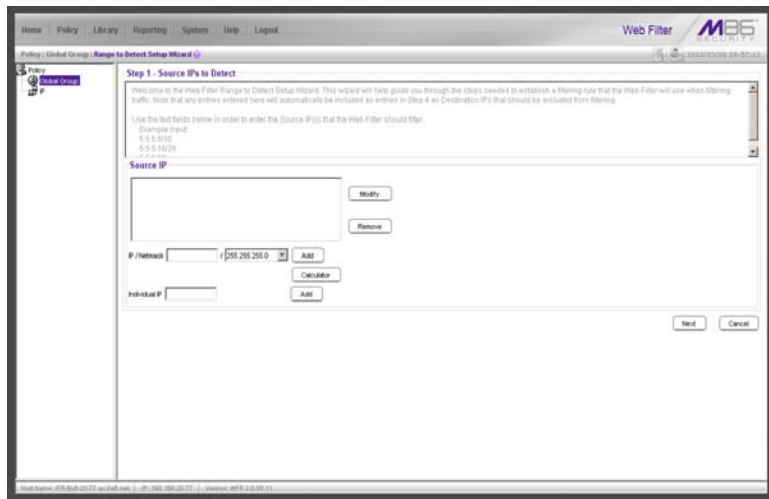



Fig. 2:2-5 Range to Detect Setup Wizard, Step 1

Since the first four pages of the Wizard contain the same fields and buttons, instructions provided for this step are not repeated for Steps 2 - 4.

1. Choose the appropriate option for entering the IP address(es):
 - **IP / Netmask** - use these fields to specify a range of IP addresses
 - **Individual IP** - use this field to enter a single IP address

2. Click **Add** to include the segment in the list box above.

 **NOTE:** To modify the segment, select it from the list box and click **Modify** to move the segment to the field(s) below for editing. To remove the segment, select it from the list box and click **Remove**.

3. Click **Next** to go to the next page of the Wizard.

 **NOTE:** Click **Cancel** to be given the option to return to the main Range to Detect Settings window.

Step 2: Optional

In this step you define the destination IP address(es) to be filtered.

 **NOTE:** By making entries in Destination IP fields, traffic will be restricted to the range specified in the Source IP and Destination IP frames. This reduces the load on the Web Filter, thus enabling it to handle more traffic.

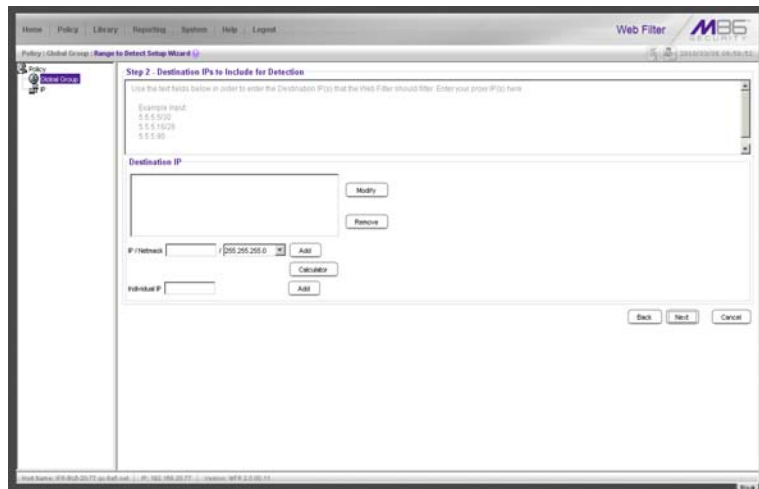

Fig. 2:2-6 Range to Detect Setup Wizard window, Step 2

 **NOTE:** For Steps 2-6, click **Back** to return to the previous page of the Wizard.

Step 3: Optional

In this step you define the source IP address(es) to be excluded from filtering.

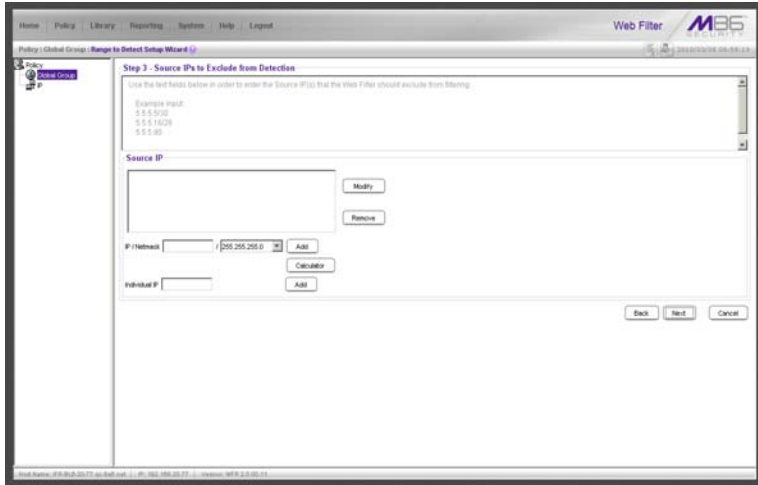

Fig. 2:2-7 Range to Detect Setup Wizard window, Step 3

Step 4: Optional

In this step you define the destination IP address(es) to be excluded from filtering. Any entries from the list box in Step 1 automatically display in the list box above.



NOTE: By making entries in Destination IP fields, traffic will be restricted to the range specified in the Source IP and Destination IP frames. This reduces the load on the Web Filter, thus enabling it to handle more traffic.

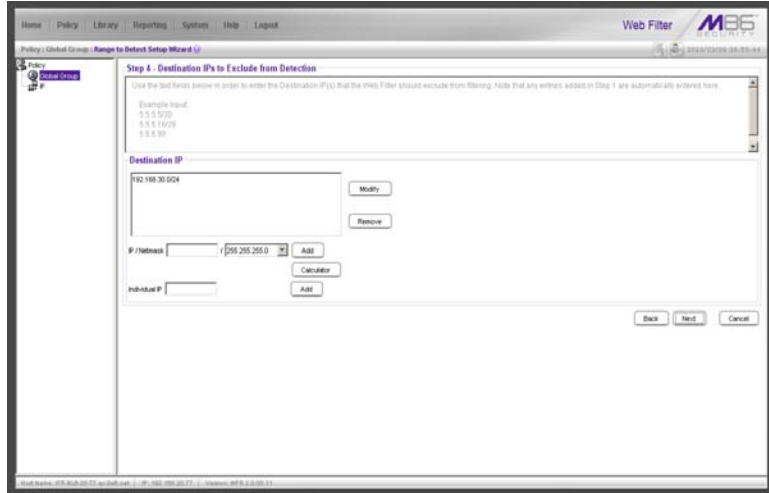

Fig. 2:2-8 Range to Detect Setup Wizard window, Step 4

Step 5: Optional

In this step you enter destination port numbers to be excluded from filtering.

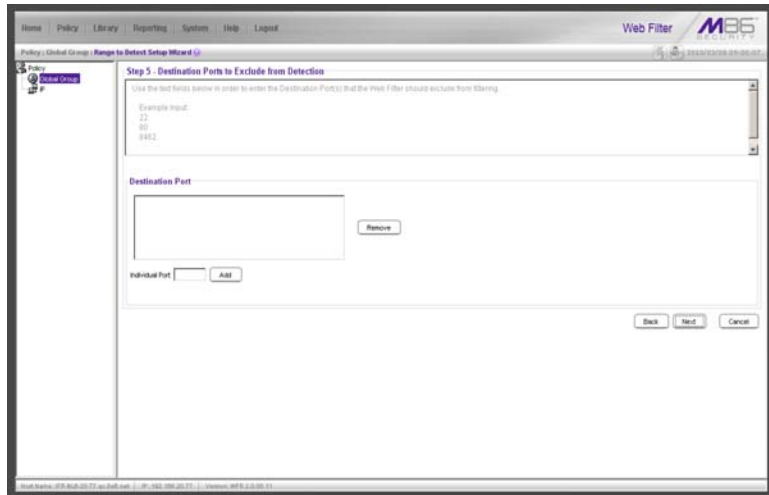

Fig. 2:2-9 Range to Detect Setup Wizard window, Step 5

1. In the **Individual Port** field, enter the port number to be excluded from filtering.
2. Click **Add** to include the entry in the list box above.



NOTE: To remove the port number, select it from the list box and click **Remove**.

3. Click **Next** to go to the last page of the Wizard.

Step 6

In this final step of the Wizard you review your entries and make modifications, if necessary.

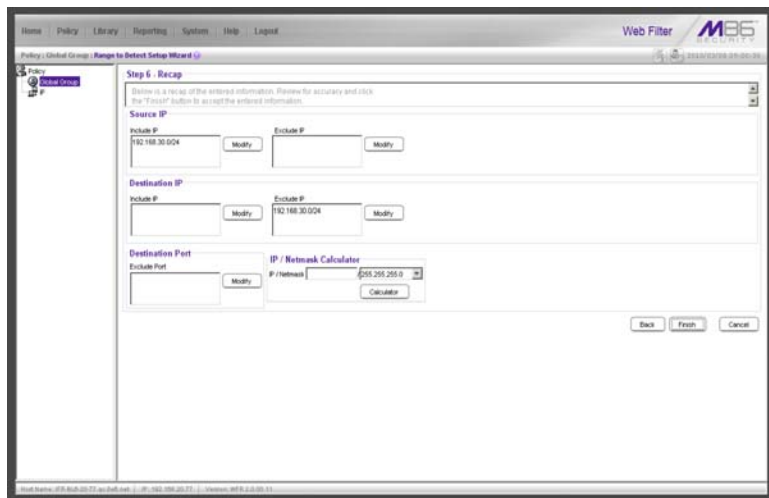

Fig. 2:2-10 Range to Detect Setup Wizard window, Step 6

1. Review the contents in all list boxes.
2. Perform one of the following actions:
 - click the **Modify** button to the right of the list box if you need to make changes. This action takes you to that page of the Wizard where you make your edits. Click **Next** until you return to Step 6.

- click **Finish** to accept all your entries. This action takes you to the main Range to Detect Settings window where the segment you entered now displays in the Current Ranges list box.

Range to Detect Advanced Settings

Click the **Advanced Settings** button to display the Range to Detect Advanced Settings window:

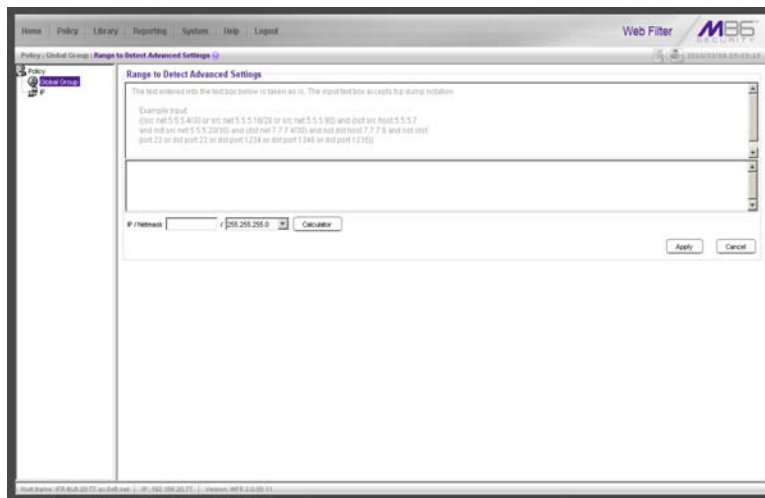

Fig. 2:2-11 Range to Detect Advanced Settings window

1. Enter the settings in the list box, using the correct syntax. Refer to the examples above.



TIP: Use the Calculator to calculate IP ranges without any overlaps. Enter the **IP** address, select the **Netmask**, and then click **Calculate** to display results in the Min Host and Max Host fields. Click **Close** to exit.



NOTE: Click **Cancel** to be given the option to return to the main Range to Detect Settings window without saving your settings.

2. Click **Apply** to accept your entries and to return to the main Range to Detect Settings window.

Modify a Segment of the Network

To modify a segment:

1. In the main Range to Detect Settings window (see Fig. 2:2-2), select the segment from the Current Ranges list box.
2. Click **Modify** to go to the second page (see Fig. 2:2-4).
3. Click one of the following buttons to select the procedure for modifying the segment:
 - **Start the Setup Wizard** - clicking this button takes you to Step 6 of the Range to Detect Setup Wizard (see Fig. 2:2-10). Follow the instructions in the Range to Detect Setup Wizard sub-section for Step 6.
 - **Advanced Settings** - clicking this button takes you to the Range to Detect Advanced Settings window (see Fig. 2:2-11). Follow the instructions in the Range to Detect Advanced Settings sub-section.

Remove a Segment from the Network

To remove a segment:

1. In the main Range to Detect Settings window (see Fig. 2:2-2), select the segment from the Current Ranges list box.
2. Click **Remove**.

Rules window

The Rules window displays when Rules is selected from the Global Group menu. This window is used for adding a filtering rule when creating a filtering profile for an entity.

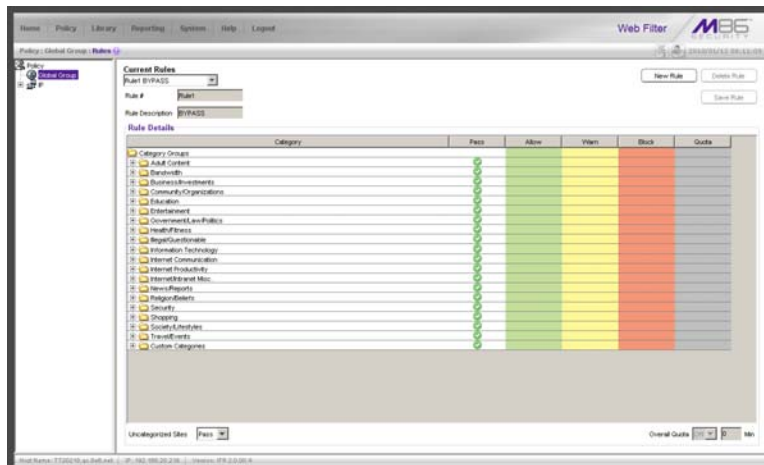

Fig. 2.2-12 Rules window

By default, “Rule1 BYPASS” displays in the **Current Rules** pull-down menu. The other choices in this pull-down menu are “Rule2 BLOCK Porn”, “Rule3 Block IM and Porn”, “Rule4 M86 CIPA Compliance” (which pertains to the Children’s Internet Protection Act), and “Rule5 Block All”. By default, “Rule1” displays in the **Rule #** field, “BYPASS” displays in the **Rule Description** field, and **Uncategorized Sites** are allowed to Pass.

View Criteria for a Rule

Select the rule from the **Current Rules** pull-down menu to populate the Rule Details frame with settings made for that rule. If this rule is not an M86 pre-defined rule it can be modified or deleted. A rule that does not yet exist can be added using any rule in this list as a template, if necessary.

Add a Rule

To create a new rule:

1. Click **New Rule** to populate the **Rule #** field with the next consecutive rule number available.
2. Enter up to 20 characters for a unique **Rule Description** that describes the theme for that rule.
3. By default, in the Rule Details frame, all library categories in the Category Groups tree are set to pass—indicating that the end user can access URLs in all library categories. This filter setting is designated by the check mark inside a green circle in the **Pass** column.



TIP: In the Category Groups tree, double-click the group envelope to open that segment of the tree and to view library categories belonging to that group.

To change the filter setting for a category group/library category, double-click the column (Allow, Warn, Block) in the row corresponding to that category group/library category to move the check mark to that column:

- **Allow** - URLs in this category will be added to the end user's white list.
- **Warn** - URLs in this category will warn the end user that the URL he/she requested can be accessed, but may be against the organization's policies. The end user can view the URL after seeing a warning message and agreeing to its terms.
- **Block** - URLs in this category will be blocked.



NOTE: If a category group does not display any filter setting (i.e. the check mark does not display in any column for the category group), one or more library categories within that group has a filter setting in a column other than the filter setting designated for all collective library categories within that group. For example, if in the Adult Content category group some of the library categories have a block setting and other library categories have a warn setting, there would be no category group filter setting, since all library categories do not have the same filter setting.



TIPS: Multiple categories can be assigned the same filter setting by clicking each category while pressing the Ctrl key on your keyboard, and then double-clicking in the appropriate column.

Blocks of categories can be assigned the same filter setting by clicking the first category, and then pressing the Shift key on your keyboard while clicking the last category, and then double-clicking in the appropriate column.

4. Make a selection from the **Uncategorized Sites** pull-down menu to specify how to handle a URL that has not yet been categorized: “Pass”, “Warn”, or “Block”.
5. To use the quota feature to restrict the end user’s access to a passed library group/category, do the following:
 - In the **Quota** column, enter the number of minutes the user will be able to access the library group/category. The minimum number of minutes is “1” and the maximum is “1439” (one day minus one minute). The number of minutes entered here combines with the seconds per hit (minimum one second to maximum 3600 seconds) defined in the Quota Settings window to determine when the end user will be blocked from further access to URLs in that library group/category.



TIP: If a quota entry is made for a category group, all library categories in that group will show the same number of quota minutes.



NOTE: See the Quota Settings window in Chapter 1: System screen for more information on configuring quota settings and resetting quotas for end users currently blocked by quotas.

- The **Overall Quota** field becomes enabled if a quota is entered for any library group/category. By default, the enabled Overall Quota is turned “Off”. If turned “On”, enter the number of minutes in the **Min** field to indicate when the end user’s access to passed library groups/categories with quotas will be blocked. If the end user spends this amount of time at URLs in any quota-marked library group/category, the Overall Quota overrides the number of minutes defined for each individual quota.
6. Click **Add Rule** to include your rule to the list that displays in the pull-down menu.

Modify a Rule

After a rule is added, it can later be modified. To make changes to a rule:

1. Select the rule from the **Current Rules** pull-down menu.
2. Modify settings for library groups and categories in the Rule Details frame.
3. Click **Save Rule**.

Copy a Rule

As a time saving practice, a rule can be used as a basis when creating another similar rule. To copy a rule:

1. Select the rule to be copied from the list of **Current Rules**.
2. Click **New Rule** to populate the Rule # field with the next available rule number, and to activate the Rule Description field.
3. Enter up to 20 characters for a unique **Rule Description** that describes the theme for that rule.
4. Modify settings for library groups and categories in the Rule Details frame.

5. Click **Save Rule**.

Remove a Rule

To delete a rule:

1. Select the rule from the **Current Rules** pull-down menu.
2. Click **Delete Rule**.

Global Group Profile window

The Global Group Profile window displays when Global Group Profile is selected from the Global Group menu. This window is used for viewing/creating the global (default) filtering profile that will be used by all users on the network unless a unique filtering profile is created for an entity. Click the following tabs in this window: Category, Port, Default Redirect URL, and Filter Options. Entries in these tabs comprise the profile string for the global group.

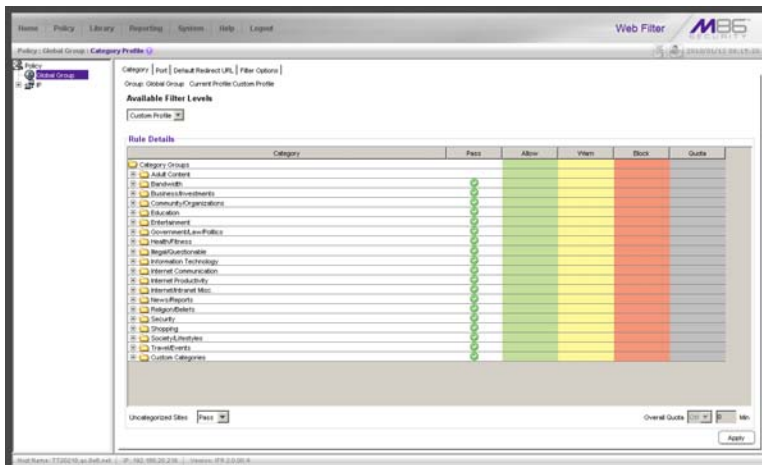

Fig. 2:2-13 Global Group Profile window, Category tab

Category Profile

Category Profile displays by default when Global Group Profile is selected from the Global Group menu, or when the Category tab is clicked. This tab is used for assigning filter settings to category groups/library categories for the global group profile.

By default, “Custom Profile” displays in the Available Filter Levels pull-down menu, and **Uncategorized Sites** are allowed to Pass.

Create, Edit a List of Selected Categories

For the category portion of the global group filtering profile, in the Rule Details frame all library categories in the Category Groups tree are set to pass, except “Child Pornography” and “Pornography/Adult Content”—indicating that the end user can access URLs in all other library categories. This filter setting is designated by the check mark inside a green circle in the **Pass** column for all category groups except Adult Content.



TIP: *In the Category Groups tree, double-click the group envelope to open that segment of the tree and to view library categories belonging to that group.*

1. To change a category group/library category filter setting, double-click the column (Allow, Warn, Block) in the row corresponding to that category group/library category to move the check mark to that column:
 - **Allow** - URLs in this category will be added to the end user’s white list.
 - **Warn** - URLs in this category will warn the end user that the URL he/she requested can be accessed, but may be against the organization’s policies. The end user can view the URL after seeing a warning message and agreeing to its terms.

- **Block** - URLs in this category will be blocked.



NOTE: If a category group does not display any filter setting (i.e. the check mark does not display in any column for the category group), one or more library categories within that group has a filter setting in a column other than the filter setting designated for all collective library categories within that group. For example, if in the Adult Content category group some of the library categories have a block setting and other library categories have a warn setting, there would be no category group filter setting, since all library categories do not have the same filter setting.



TIPS: Multiple categories can be assigned the same filter setting by clicking each category while pressing the Ctrl key on your keyboard, and then double-clicking in the appropriate column.

Blocks of categories can be assigned the same filter setting by clicking the first category, and then pressing the Shift key on your keyboard while clicking the last category, and then double-clicking in the appropriate column.

2. Make a selection from the **Uncategorized Sites** pull-down menu to specify how to handle a URL that has not yet been categorized: “Pass”, “Warn”, or “Block”.
3. To use the quota feature to restrict the end user’s access to a passed library group/category, do the following:
 - In the **Quota** column, enter the number of minutes the user will be able to access the library group/category. The minimum number of minutes is “1” and the maximum is “1439” (one day minus one minute). The number of minutes entered here combines with the seconds per hit (minimum one second to maximum 3600 seconds) defined in the Quota Settings window to determine when the end user will be blocked from further access to URLs in that library group/category.



TIP: If a quota entry is made for a category group, all library categories in that group will show the same number of quota minutes.



NOTE: See the Quota Settings window in Chapter 1: System screen for more information on configuring quota settings and resetting quotas for end users currently blocked by quotas.

- The **Overall Quota** field becomes enabled if a quota is entered for any library group/category. By default, the enabled Overall Quota is turned “Off”. If turned “On”, enter the number of minutes in the **Min** field to indicate when the end user’s access to passed library groups/categories with quotas will be blocked. If the end user spends this amount of time at URLs in any quota-marked library group/category, the Overall Quota overrides the number of minutes defined for each individual quota.

4. Click **Apply** to apply your settings at the global level.

Port

Port displays when the Port tab is clicked. This tab is used for blocking access to specified ports for the global filtering profile.

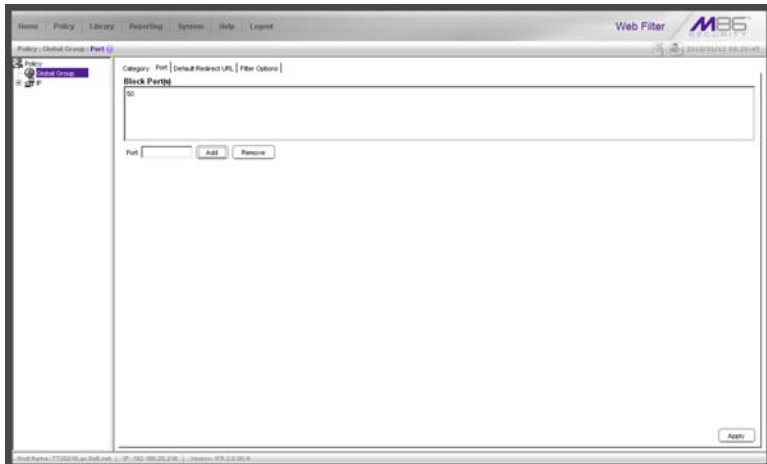

Fig. 2:2-14 Global Group Profile window, Port tab

Create, Edit a List of Service Ports

All service ports are filtered by default. To block a service port from being accessed by global filtering profile users:

1. Enter the port number in the **Port** field.
2. Click **Add**. Each port number you add displays in the Block Port(s) list box.
3. Click **Apply** to apply your settings at the global level.

To remove a port number from the list box:

1. Select the port number.
2. Click **Remove**.
3. Click **Apply** to apply your settings at the global level.

Default Redirect URL

Default Redirect URL displays when the Default Redirect URL tab is clicked. This tab is used for specifying the URL to be used for redirecting users who attempt to access a site or service set up to be blocked for the global filtering profile.

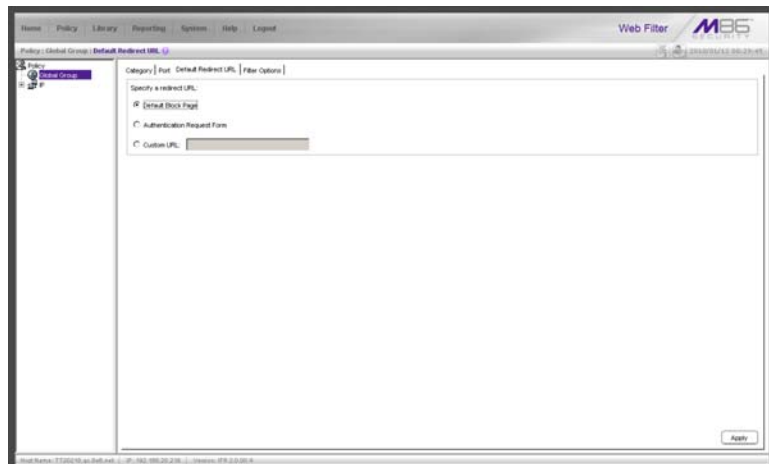

Fig. 2:2-15 Global Group Profile window, Default Redirect URL tab

Create, Edit the Redirect URL

1. Specify the type of redirect URL to be used: “Default Block Page”, “Authentication Request Form”, or “Custom URL”.

If “Custom URL” is selected, enter the redirect URL in the corresponding text box. Users will be redirected to the designated page at this URL instead of the block page.

2. Click **Apply** to apply your settings.

Filter Options

Filter Options displays when the Filter Options tab is clicked. This tab is used for specifying which filter option(s) will be applied to the global group filtering profile.

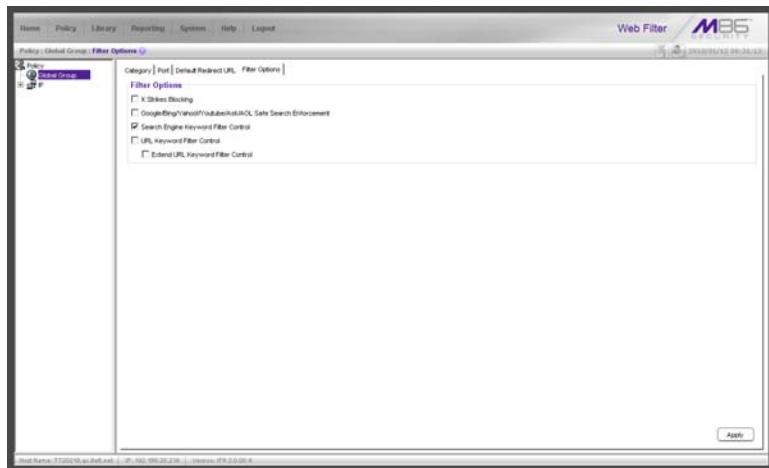

Fig. 2:2-16 Global Group Profile window, Filter Options tab

Create, Edit the Filter Options

1. Click the checkbox(es) corresponding to the option(s) to be applied to the global group filtering profile: “X Strikes Blocking”, “Google/Bing/Yahoo!/Youtube/Ask/AOL Safe Search Enforcement”, “Search Engine Keyword Filter

Control”, “URL Keyword Filter Control”. If URL Keyword Filter Control is selected, the “Extend URL Keyword Filter Control” option can be selected.

2. Click **Apply** to apply your settings.

X Strikes Blocking

With the X Strikes Blocking option enabled, an end user who attempts to access inappropriate sites on the Internet will be locked out from his/her workstation after a specified number of tries within a fixed time period.



NOTE: See the X Strikes Blocking window in Chapter 1: System screen for information on setting up the X Strikes Blocking feature.

Google/Bing/Yahoo!/Youtube/Ask/AOL Safe Search Enforcement

With the Google/Bing/Yahoo!/Youtube/Ask/AOL Safe Search Enforcement option enabled, Google, Bing.com, Yahoo!, YouTube, Ask.com, and AOL’s “strict” SafeSearch Filtering option will be used whenever end users perform a Google, Bing.com, Yahoo!, YouTube, Ask.com, or AOL Web search or Image search.



WARNINGS: This feature is not compatible with the proxy environment as it will cause overblocking.

An inappropriate image will only be blocked if that image is included in M86’s library or is blocked by Google, Bing.com, Yahoo!, YouTube, Ask.com, or AOL.

If this option is used in conjunction with the X Strikes Blocking feature and a user is performing an inappropriate Google, Bing.com, Yahoo!, YouTube, Ask.com, or AOL Image search, the number of strikes that user will receive is based upon the amount of time it will take for unacceptable Google, Bing.com, Yahoo!, YouTube, Ask.com, or AOL images returned by the query to load on the page. The user receives only one strike if all inappropriate images load within the tolerance time range of a given strike.

Search Engine Keyword Filter Control

With the Search Engine Keyword Filter Control option enabled, search engine keywords can be set up to be blocked. When a user enters a keyword in the search engine, if that keyword has been set up to be blocked, the search will not be performed. Search engine keywords are entered in the Search Engine Keywords window of M86 supplied library categories and custom library categories.



NOTES: Search engine keyword filtering relies on an exact keyword match. For example, if the word “sex” is set up to be blocked, but “sexes” is not set up to be blocked, a search will be allowed on “sexes” but not “sex”. However, if the word “gin” is set up to be blocked, a search on “cotton gin” will be blocked since the word “gin” is blocked.

To set up search engine keywords in a Search Engine Keywords window, see the following sections of this user guide for the specified library type:

- *M86 Supplied Categories - see Chapter 3: Library screen, Search Engine Keywords window in this section.*
- *Custom Categories - see the Group Administrator Section, Chapter 2: Library screen, Search Engine Keywords window.*

URL Keyword Filter Control

With the URL Keyword Filter Control option enabled, URL keywords can be set up to be blocked. When a user enters a keyword in the address line of a browser window, if that keyword has been set up to be blocked, the user will be denied access to that site or service. URL keywords are entered in the URL Keywords window of M86 supplied library categories and custom library categories.

With the “Extend URL Keyword Filter Control” option enabled, a URL keyword search will be extended after the “?” character in a URL.



NOTE: *To set up URL keywords in a URL Keywords window, see the following sections of this user guide for the specified library type:*

- *M86 Supplied Categories - see Chapter 3: Library screen, URL Keywords window, in this section.*
- *Custom Category - see the Group Administrator Section, Chapter 2: Library screen, URL Keywords window.*



WARNING: *If this feature is activated, use extreme caution when setting up URL keywords for filtering. If a keyword that is entered in a browser’s address window contains the same consecutive characters as a keyword set up to be blocked, users will be denied access to URLs that are not even within blocked categories. For example, if all URL keywords containing “sex” are blocked, users will not be able to access a non-pornographic site such as <http://www.essex.com>.*

Override Account window

The Override Account window displays when Override Account is selected from the Global Group menu. This window is used for creating an override account that allows an IP group user to bypass settings at the minimum filtering level. A user with an override account will be able to access categories and service ports blocked at the minimum filtering level.

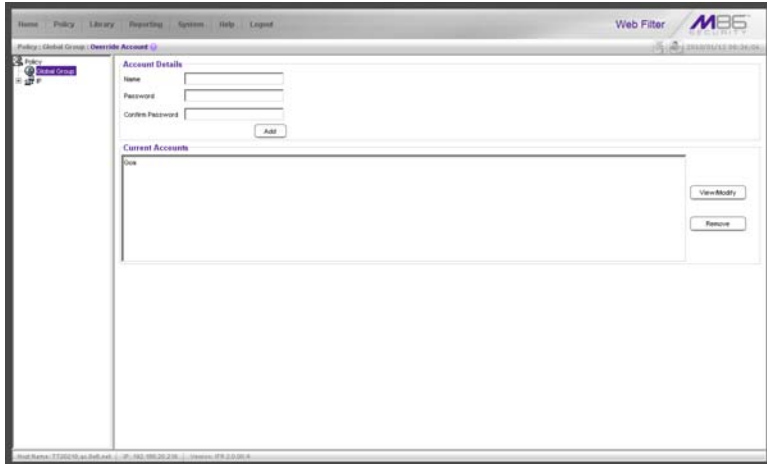

Fig. 2:2-17 Override Account window



NOTES: A user can have only one override account. If an override account was previously created for a user in a master IP group, only that override account will be effective, unless that account is deleted from the IP group. See the Override Account window in Chapter 1 of the Group Administrator Section for information on setting up an override account for a user in an IP group.

See Appendix C: Override Pop-up Blockers for information on how a user with an override account can authenticate if a pop-up blocker is installed on his/her workstation.

Add an Override Account

To create an Override Account profile:

1. In the Account Details frame, enter the username in the **Name** field.
2. Enter the **Password**.
3. Make the same entry again in the **Confirm Password** field.
4. Click **Add** to include the username in the list box of the Current Accounts frame, and to open the pop-up window containing the Current Accounts name as well as tabs to be used for specifying the components of the override account profile.
5. Click each of the tabs (Rule, Redirect, Filter Options) and specify criteria to complete the override account profile. (See Category Profile, Redirect URL, and Filter Options in this sub-section for information on the Rule, Redirect, and Filter Options tabs.)
6. Click **Apply** to activate the override account.
7. Click **Close** to close the pop-up window.

Category Profile

The Rule tab is used for creating the categories portion of the override account profile.

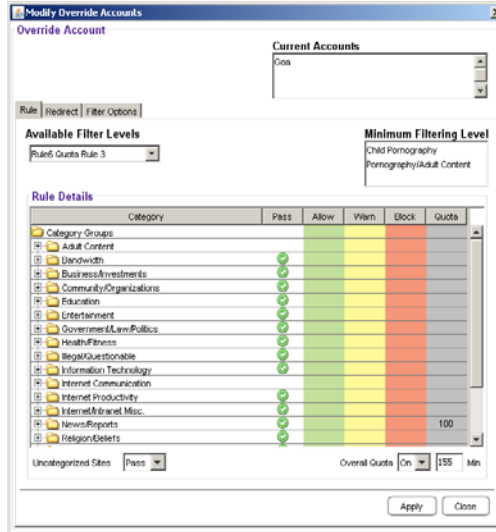



Fig. 2:2-18 Override Account pop-up window, Rule tab

To create the category profile:

1. Select a filtering rule from the available choices in the **Available Filter Levels** pull-down menu. This action automatically populates the Pass, Allow, Warn, and/or Block columns in the Rule Details frame with filter settings for each category group/library category in the Category Groups tree.

 **TIP:** In the Category Groups tree, double-click the group envelope to open that segment of the tree and to view library categories belonging to that group.

 **NOTE:** If a category group does not display any filter setting (i.e. the check mark does not display in any column for the category group), one or more library categories within that group has a filter setting in a column other than the filter setting designated for all collective library categories within that group. For example, if

in the Adult Content category group some of the library categories have a block setting and other library categories have a warn setting, there would be no category group filter setting, since all library categories do not have the same filter setting.

2. To change the filter setting for a category group/library category, double-click the column (Pass, Allow, Warn, Block) in the row corresponding to that category group/library category to move the check mark to that column:
 - **Pass** - URLs in this category will pass to the end user.
 - **Allow** - URLs in this category will be added to the end user's white list.
 - **Warn** - URLs in this category will warn the end user that the URL he/she requested can be accessed, but may be against the organization's policies. The end user can view the URL after seeing a warning message and agreeing to its terms.
 - **Block** - URLs in this category will be blocked.



TIPS: *Multiple categories can be assigned the same filter setting by clicking each category while pressing the Ctrl key on your keyboard, and then double-clicking in the appropriate column.*

Blocks of categories can be assigned the same filter setting by clicking the first category, and then pressing the Shift key on your keyboard while clicking the last category, and then double-clicking in the appropriate column.

3. Make a selection from the **Uncategorized Sites** pull-down menu to specify how to handle a URL that has not yet been categorized: "Pass", "Warn", or "Block".
4. To use the quota feature to restrict the end user's access to a passed library group/category, do the following:

- In the **Quota** column, enter the number of minutes the user will be able to access the library group/category. The minimum number of minutes is “1” and the maximum is “1439” (one day minus one minute). The number of minutes entered here combines with the seconds per hit (minimum one second to maximum 3600 seconds) defined in the Quota Settings window to determine when the end user will be blocked from further access to URLs in that library group/category.



TIP: *If a quota entry is made for a category group, all library categories in that group will show the same number of quota minutes.*



NOTE: *See the Quota Settings window in Chapter 1: System screen for more information on configuring quota settings and resetting quotas for end users currently blocked by quotas.*

- The **Overall Quota** field becomes enabled if a quota is entered for any library group/category. By default, the enabled Overall Quota is turned “Off”. If turned “On”, enter the number of minutes in the **Min** field to indicate when the end user’s access to passed library groups/categories with quotas will be blocked. If the end user spends this amount of time at URLs in any quota-marked library group/category, the Overall Quota overrides the number of minutes defined for each individual quota.
5. Click **Apply** to apply your settings to the override account profile.
 6. Click another tab (Redirect or Filter Options) to continue creating the override account profile, or click **Close** to close the pop-up window and to return to the Override Account window.

Redirect URL

The Redirect tab is used for specifying the URL to be used for redirecting the user if he/she attempts to access a site or service set up to be blocked.

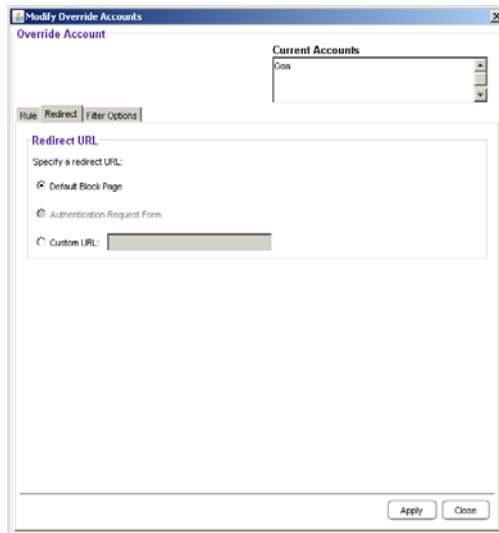

Fig. 2:2-19 Override Account pop-up window, Redirect tab

1. Specify the type of redirect URL to be used: “Default Block Page”, “Authentication Request Form”, or “Custom URL”.

If “Custom URL” is selected, enter the redirect URL in the corresponding text box. The user will be redirected to the designated page at this URL instead of the block page.

2. Click **Apply** to apply your settings to the override account profile.
3. Click the Filter Options tab to continue creating the override account profile, or click **Close** to close the pop-up window and to return to the Override Account window.

Filter Options

The Filter Options tab is used for specifying which filter option(s) will be applied to the override account profile.

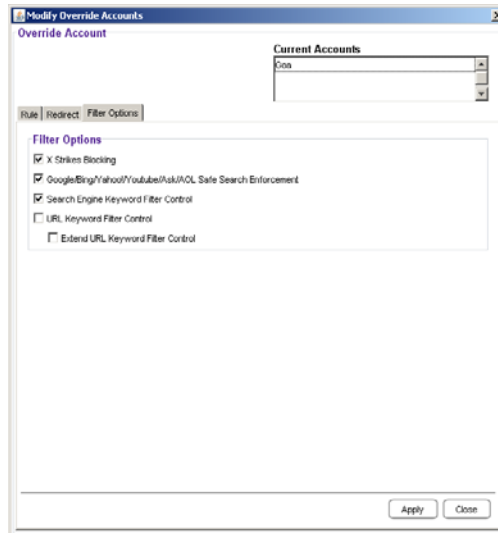

Fig. 2:2-20 Override Account pop-up window, Filter Options tab

1. Click the checkbox(es) corresponding to the option(s) to be applied to the override account filtering profile:
 - “X Strikes Blocking” - With the X Strikes Blocking option enabled, if the user attempts to access inappropriate sites on the Internet, he/she will be locked out from his/her workstation after a specified number of tries within a fixed time period.



NOTE: See the X Strikes Blocking window in Chapter 1: System screen for information on setting up the X Strikes Blocking feature.

- “Google/Bing/Yahoo!/Youtube/Ask/AOL Safe Search Enforcement” - With the Google/Yahoo!/Youtube/Ask/AOL Safe Search Enforcement option enabled, Google, Bing.com, Yahoo!, YouTube, Ask.com, and AOL’s “strict” SafeSearch Filtering option will be used whenever the end user performs a Google, Bing.com, Yahoo!, YouTube, Ask.com, or AOL Web search or Image search.



WARNING: *If this option is used in conjunction with the X Strikes Blocking feature and a user is performing an inappropriate Google, Bing.com, Yahoo!, YouTube, Ask.com, or AOL Image search, the number of strikes that user will receive is based upon the amount of time it will take for unacceptable Google, Bing.com, Yahoo!, YouTube, Ask.com, or AOL images returned by the query to load on the page. The user will receive only one strike if all inappropriate images load within the tolerance time range of a given strike.*

- “Search Engine Keyword Filter Control” - With the Search Engine Keyword Filter Control option enabled, search engine keywords can be set up to be blocked. When the user enters a keyword in the search engine, if that keyword has been set up to be blocked, the search will not be performed. Search engine keywords are entered in the Search Engine Keywords window of M86 supplied library categories and custom library categories.



NOTE: *To set up search engine keywords in a Search Engine Keywords window, see the following sections of this user guide for the specified library type:*

- *M86 Supplied Categories - see Chapter 3: Library screen, Search Engine Keywords window.*
- *Custom Categories - see the Group Administrator Section, Chapter 2: Library screen, Search Engine Keywords window.*

- “URL Keyword Filter Control” - With the URL Keyword Filter Control option enabled, URL keywords can be set up to be blocked. When the user enters a keyword in the address line of a browser window, if that keyword has been set up to be blocked, the user will be denied access to that site or service. URL keywords are entered in the URL Keywords window of M86 supplied library categories and custom library categories.

With the “Extend URL Keyword Filter Control” option enabled, a URL keyword search will be extended after the "?" character in a URL.



NOTE: To set up URL keywords in a URL Keywords window, see the following sections of this user guide for the specified library type:

- *M86 Supplied Categories* - see Chapter 3: Library screen, URL Keywords window.
- *Custom Category* - see the Group Administrator Section, Chapter 2: Library screen, URL Keywords window.

2. Click **Apply** to apply your settings to the override account profile.
3. Click **Close** to close the pop-up window and to return to the Override Account window.

Edit an Override Account

Change the Password

To change an override account's password:

1. In the Current Accounts frame, select the username from the list box.
2. In the Account Details frame, enter the username in the **Name** field.
3. Enter the new **Password**.

4. Make the same entry again in the **Confirm Password** field.
5. Click **View/Modify** to open the pop-up window.
6. Click **Apply**.
7. Click **Close** to close the pop-up window.

Modify an Override Account

To modify an override account:

1. In the Current Accounts frame, select the username from the list box.
2. Click **View/Modify** to open the pop-up window.
3. Click the tab in which to make modifications (Rule, Redirect, Filter Options).
4. Make your edits in this tab and in any other tab, if necessary.
5. Click **Apply**.
6. Click **Close** to close the pop-up window.

Delete an Override Account

To delete an override account:

1. In the Current Accounts frame, select the username from the list box.
2. Click **Remove**.

Approved Content Settings window

The Approved Content Settings window displays when Approved Content (incl. VuSafe) is selected from the Global Group menu. This window is used for granting designated users access to a specified set of approved online videos posted to YouTube or SchoolTube via a portal managed by someone within your organization.

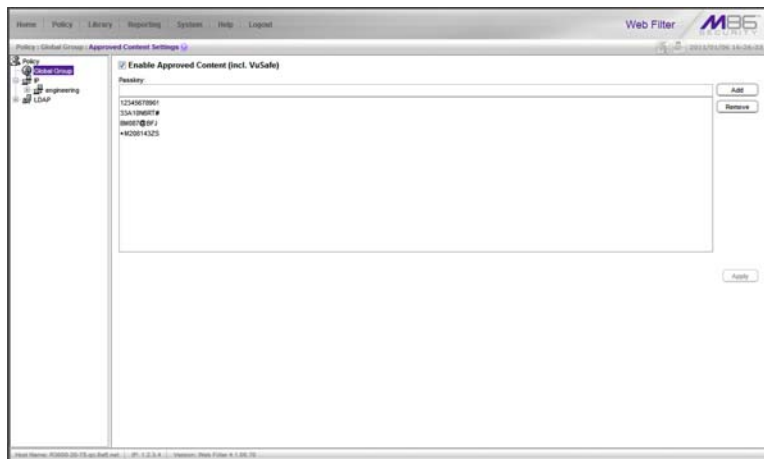

Fig. 2:2-21 Approved Content Settings window

Approved Content feature and VuSafe

The Approved Content feature, primarily used by the education sector, lets administrators specify which online videos posted to YouTube or SchoolTube are appropriate for students to view, while blocking all other videos posted to these video viewing Web sites.

VuSafe is an online content library to which educators can post approved, educational videos for students to watch in a secure environment. VuSafe removes all outside content on sites such as YouTube.com, eliminating access to inappropriate material. This free Web-based service requires no additional software or hardware setup. Enabling the

Approved Content feature in a user's profile gives that user access to videos posted to VuSafe.

Approved Content setup and configuration

There are two parts to set up in order to use the Approved Content feature:

- A portal for viewing videos must be created
- The passkey of each approved video must be entered in the Approved Content Settings window for the user's profile



NOTE: *If Pattern Blocking is enabled (System > Control > Filter > Service Control frame), then the filtering profile must "Allow" the Flash Video (FLV) pattern (Category Groups > Bandwidth > Streaming Media > Flash Video).*

Approved Content portal setup

To create a portal for users to view approved YouTube and/or SchoolTube videos, you will need the following:

- Online Web page or intranet page that you or someone in your organization will maintain for users to view approved videos
- Text editor tool such as Notepad or TextPad
- MD5 checksum calculator tool

Once you have access to the aforementioned items, follow the instructions in the M86 Approved Content Portal Setup document at <http://www.m86security.com/software/8e6/docs/ug/misc/wf.ac.4.1.00.pdf> .

As explained in the portal setup document, a passkey must be created for each video to be included in the portal. This passkey needs to be entered in the Approved Content Settings window associated with the user's profile.

Approved Content Settings entries

Once you have passkeys created for the approved videos, you can begin making entries in the Approved Content Settings window.

Step 1: Enable Global Group Passkey inheritance

To allow any user to inherit a set of passkeys if the Approved Content feature is enabled in his/her profile, click the “Enable Approved Content (incl. VuSafe)” checkbox.

Step 2: Add/Remove Passkeys

To add a passkey to the Passkey list box:

1. Enter the eight to 20 character code (comprised of at least one alpha character, one numeric character, and one special character).



TIP: *The passkey entry is case-sensitive and must precisely match the passkey used for the video.*

2. Click **Add**.



TIP: *To remove a passkey from the list box, select it and then click **Remove**.*

Step 3: Save your entries

Click **Apply** to save your entries.



NOTE: *By disabling the inheritance of passkeys, none of the passkeys entered and saved in the Passkeys list box will be available for users set up in the Policy tree. Though these users can be set up to use the Approved Content feature, they will need to have passkeys entered and saved in their profiles.*

Minimum Filtering Level window

The Minimum Filtering Level window displays when Minimum Filtering Level is selected from the Global Group menu. This window is used for establishing the minimum filtering level that will apply to all users who belong to a group, and to any group using a filtering profile other than the global (default) filtering profile.

The minimum filtering level is created by making selections from the list of library categories and service ports. These settings can be bypassed if a user has an override account.



NOTE: See the *Override Account window* in this chapter and in *Chapter 1 of the Group Administrator Section* for more information about override accounts.

Click the following tabs in this window: Category, Port, and Min. Filter Bypass. Entries in the Category and Port tabs comprise the profile string for the minimum filtering level.

Minimum Filtering Categories

Minimum Filtering Categories displays by default when Minimum Filtering Level is selected from the Global Group menu, or when the Category tab is clicked. This tab is used for making selections from the list of library categories, and specifying whether each of these selected categories will be opened or blocked at the minimum filtering level.

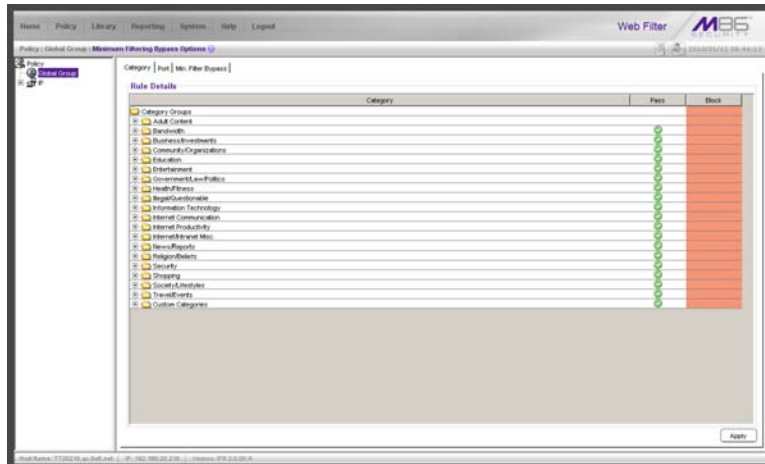

Fig. 2:2-22 Minimum Filtering Level window, Min. Filtering Categories

By default, “Child Pornography” and “Pornography/Adult Content” are assigned a Block filter setting, and all other active library categories are set to Pass. Filter settings are designated by the check mark inside a green circle in the Pass or Block column.



TIP: In the Category Groups tree, double-click the group envelope to open that segment of the tree and to view library categories belonging to that group.

Create, Edit Minimum Filtering Categories

To create the categories portion of the minimum filtering level profile:

1. Double-click the column (Pass, Block) in the row corresponding to that category group/library category to move the check mark to that column:
 - **Pass** - URLs in this category will pass to the end user.
 - **Block** - URLs in this category will be blocked.



TIPS: *Multiple categories can be assigned the same filter setting by clicking each category while pressing the Ctrl key on your keyboard, and then double-clicking in the appropriate column.*

Blocks of categories can be assigned the same filter setting by clicking the first category, and then pressing the Shift key on your keyboard while clicking the last category, and then double-clicking in the appropriate column.

2. Click **Apply** to apply your settings for the minimum filtering level.

Port

Port displays when the Port tab is clicked. This tab is used for blocking access to specified ports at the minimum filtering level.

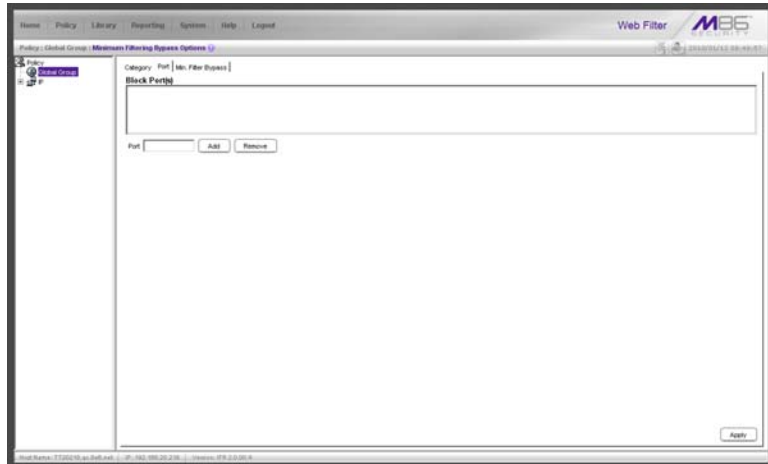

Fig. 2:2-23 Minimum Filtering Level window, Port tab

Create, Edit a List of Service Ports

All service ports are filtered by default. To block a service port from being accessed at the minimum filtering level:

1. Enter the port number in the **Port** field.
2. Click **Add**. Each port number you add displays in the Block Port(s) list box.
3. Click **Apply** to apply your settings at the minimum filtering level.

To remove a port number from the list box:

1. Select the port number.
2. Click **Remove**.

3. Click **Apply** to apply your settings at the minimum filtering level.

Minimum Filtering Bypass Options

Minimum Filtering Bypass Options displays when the Min. Filter Bypass tab is clicked. This tab is used for specifying whether users in a master IP group will be allowed to bypass the minimum filtering level with an override account or an exception URL.

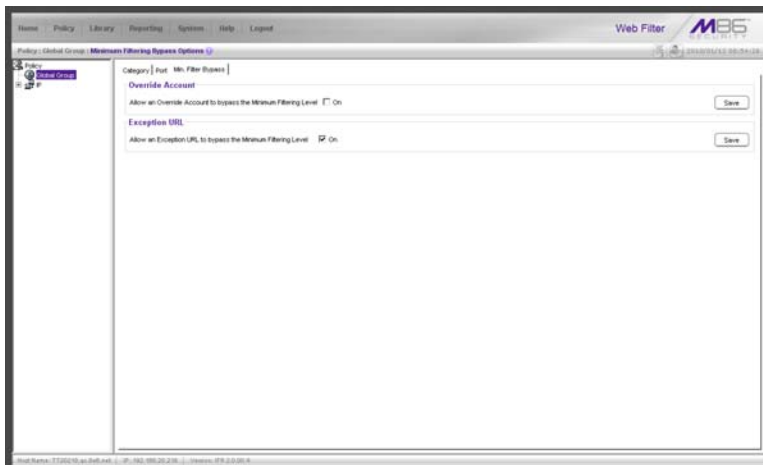

Fig. 2:2-24 Minimum Filtering Level window, Min. Filter Bypass tab



NOTE: See the *Override Account* window and *Exception URL* window of the Policy screen in the Group Administrator Section of this user guide for information on setting up an override account and exception URLs.

Specify Minimum Filtering Bypass Options

To allow a user to override settings made at the minimum filtering level:

1. In the Override Account frame, click the “On” checkbox. Any user who has an override account will be able to access content blocked at the minimum filtering level.
2. Click **Save** to apply your settings.

To allow users to bypass exception URLs set up to be blocked at the minimum filtering level:

1. In the Exception URL frame, click the “On” checkbox. Users will be able to bypass settings at the minimum filtering level, if URLs blocked at the minimum filtering level are set up to be accessed by users.
2. Click **Save** to apply your settings. (See the Exception URL window in the Group Administrator Section for more information.)

Refresh All

Refresh All Main Branches

From the Global Group menu, click Refresh All to refresh the main branches of the tree. This action should be performed whenever authentication has been enabled or disabled.

If authentication is enabled, when Refresh All is clicked, the LDAP branch of the tree displays. When authentication is disabled, when Refresh All is clicked only the IP branch of the tree displays.

IP

IP includes options for adding a master IP group and to refresh the tree list. Click the IP link to view a menu of sub-topics: Add Group, and Refresh.

Add Group

Add a Master IP Group

From the IP group menu:

1. Choose Add Group to open the Create New Group dialog box:

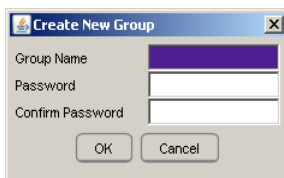

Fig. 2:2-25 Create New Group box

2. Enter up to 20 characters for the **Group Name**.



NOTES: The name of the master IP group must be less than 20 characters; cannot be "IP" or LDAP", and cannot contain spaces. The first character cannot be a digit.

The following characters cannot be used in the name: "." (period), "," (comma), ":" (colon), ";" (semi-colon), "!" (exclamation point), "?" (question mark), "&" (ampersand), "*" (asterisk), "" (quotation mark), "'" (apostrophe), "`" (grave accent mark), "~" (tilde), "^" (caret), "_" (underscore), "|" (pipe), "/" (slash), "\" (backslash)", "\\\" (double backslashes), "(" (left parenthesis), ")" (right parenthesis), "{" (left brace), "}" (right brace), "[" (left bracket), "]" (right bracket), "@" (at sign), "#" (pound sign), "\$" (dollar sign), "%" (percent sign), "<" (less than symbol), ">" (greater than symbol), "+" (plus symbol), "-" (minus sign), "=" (equals sign).

3. Enter the **Password**, and re-enter it in the **Confirm Password** field, using eight to 20 characters and at least one alpha character, one numeric character, and one special character. The password is case sensitive.
4. Click **OK** to add the group to the tree.



NOTE: Information on defining the group and its members and establishing their filtering profiles can be found in the Group Administrator Section of this user guide.

Refresh

Refresh IP Groups

From the IP group menu, click Refresh whenever changes have been made in this branch of the tree.

Chapter 3: Library screen

The Library screen is comprised of windows and dialog boxes used for adding and maintaining library categories. Library categories are used when creating or modifying filtering profiles.

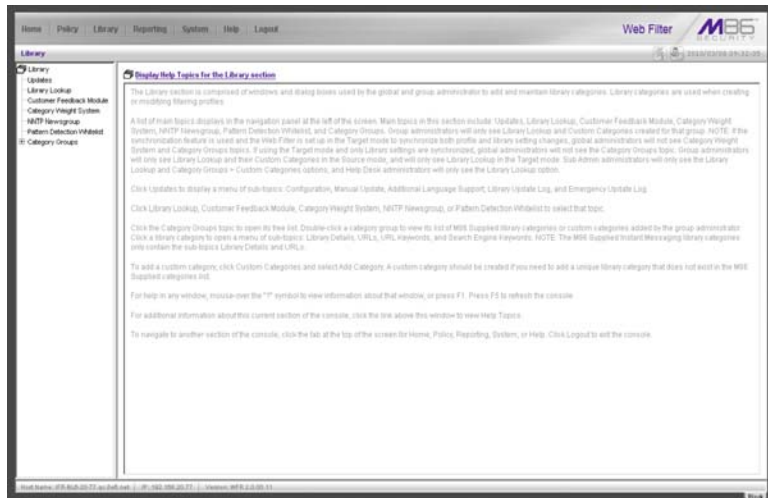

Fig. 2:3-1 Library screen

A list of main topics displays in the navigation panel at the left of the screen: Updates, Library Lookup, Customer Feedback Module, Category Weight System, NNTP Newsgroup, Pattern Detection Whitelist, and Category Groups.



NOTE: If the synchronization feature is used, a Web Filter set up in the Target mode to synchronize both profile and library setting changes will only display the Updates, Library Lookup, Customer Feedback Module, NNTP Newsgroup, and Pattern Detection Whitelist topics.

Click Updates to display a menu of sub-topics: Configuration, Manual Update, Additional Language Support, Library Update Log, and Emergency Update Log.

Click Library Lookup, Customer Feedback Module, Category Weight System, NNTP Newsgroup, or Pattern Detection Whitelist to select that topic.

To view the list of category groups, double-click Category Groups to open the tree list. Double-click a category group envelope—any envelope except Custom Categories—to view M86 supplied library categories for that group. Click a library category topic to view a menu of sub-topics for that library category item: Library Details, URLs, URL Keywords, and Search Engine Keywords.

To add a custom category, click Custom Categories and select Add Category.



NOTES: *Information on creating and maintaining Custom Categories can be found in the Group Administrator Section of this user guide.*

See Appendix A in the Appendices Section for the URL to the page that provides a list of M86 supplied library categories.

Instant Messaging library categories only include Library Details and URLs sub-topics.

Updates

Updates includes options for making configurations for library category activities. Click the Updates link to view a menu of sub-topics: Configuration, Manual Update, Additional Language Support, Library Update Log, and Emergency Update Log.

Configuration window

The Configuration window displays when Configuration is selected from the Updates menu. This window is used for making settings to allow the Web Filter to receive M86 supplied library category updates on a daily basis.



Fig. 2:3-2 Configuration window

Set a Time for Updates to be Retrieved

1. In the Schedule Time frame, by default “1:00 am” displays for the **Current automatic update time**. At this pull-down menu, specify the time at which library updates will be retrieved.
2. Click **Apply** to apply your setting.

Optional: Specify a Proxy Server

1. In the FTP Proxy Setting frame, by default “Disable” is selected. Click “Enable” if the server is in a proxy server environment. This selection activates the fields in this frame.



NOTE: *Basic authentication is the only authentication method currently supported.*

2. By default, *proxy.company.com* displays as the host name of the **Proxy Server**. Enter the host name for the proxy server in this field.
3. By default, *userid* displays in the **Username** field. Enter the username for the FTP account.
4. Enter the same password in the **Password** and **Confirm Password** fields.
5. Click **Apply** to apply your settings.

Select the Log Level

1. In the Log Level frame, select the log level to be used for specifying the log contents. Log Level 1 includes a summary of library and software update activity. Log Level 2 includes detailed information on library and software update activity.
2. Click **Apply** to apply your settings.

Manual Update window

The Manual Update to M86 Supplied Categories window displays when Manual Update is selected from the Updates menu. This window is used for updating specified M86 supplied library categories on demand from the update server, if the Web Filter has not received daily updates due to an occurrence such as a power outage.

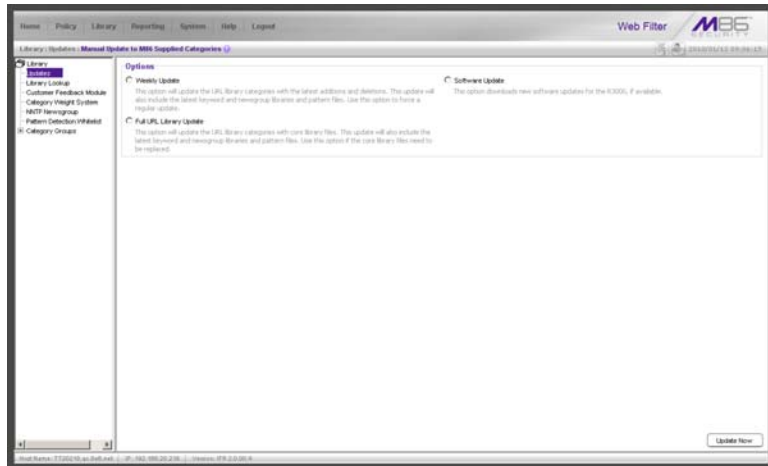

Fig. 2:3-3 Manual Update window



NOTE: The Configuration window should be used for scheduling the Web Filter to automatically download libraries on a daily basis.

Specify the Type of On Demand Update

1. Choose from the following service options by clicking the corresponding radio button:
 - **Weekly Update** - Select this option to update URL library categories with additions and deletions, and to update search engine keywords, newsgroup libraries, and IM/P2P pattern files. Choose this option to force a regular update.

- **Full URL Library Update** - Select this option to update URL library categories with core library files, and to update search engine keywords, newsgroup libraries, and IM/P2P pattern files. Choose this option to replace the core library files.
- **Software Update** - Select this option to download new software updates for the Web Filter, if available. Any software updates that are downloaded can be found in the System section of the console, in the Local Software Update window. Using that window, a software update can be selected and applied.

2. Click **Update Now** to begin the update process.



TIP: To view update activity, select *Library Update Log* from the *Updates* menu.



NOTES: For information on applying software updates, see the *Local Software Update* window in *Chapter 1: System* screen.

*For information on viewing the status of downloaded software updates, see the *Software Update Log* window in *Chapter 1*, and the *Emergency Update Log* window in this chapter.*

Additional Language Support window

The Additional Language Support window displays when Additional Language Support is selected from the Updates menu. This window is used for including additional M86-supported languages in library downloads.

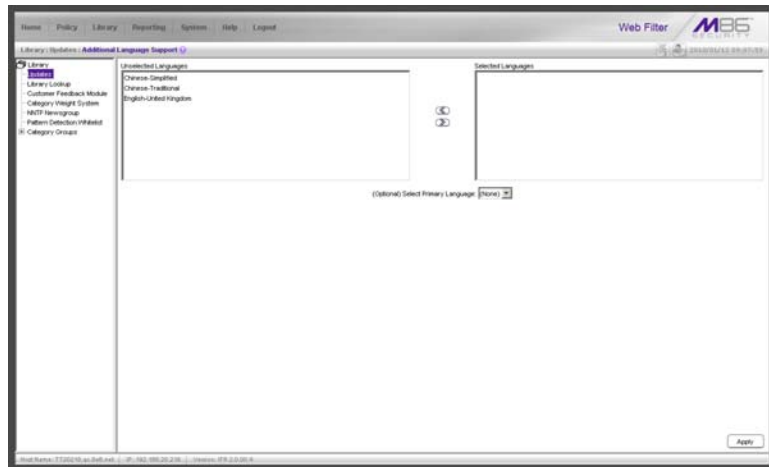

Fig. 2:3-4 Additional Language Support window

Select Additional Languages

1. Make a selection from the Unselected Languages list box and click the right arrow to move that selection to the Selected Languages list box.
2. Once the Selected Languages list box is populated, the (Optional) Select Primary Language pull-down menu includes the language selection(s) in addition to the default “None” selection.

To make an optional selection for a primary language, choose the language from the **(Optional) Select Primary Language** pull-down menu.



TIP: To move a language selection back to the Unselected Languages list box, select the item and then click the left arrow.

Download Log, View, Print Contents

Download the Log

1. Click **Download Log** to open the alert box containing a message on how to download the log file to your workstation, if using Windows XP.
2. Click **OK** to close the alert box. Two pop-up boxes open:
 - A second alert box asks you to confirm that the file was successfully saved to your machine. Click **OK** in this box after the download is completed.
 - In the file download dialog box, select the “save” option; this action opens the window on your workstation where you specify the filename for the file and where to save the file.
3. Select the folder in which to save the file, and then enter the **File name**, retaining the “.zip” file extension. Click **Save** to begin downloading the zip file to your workstation.



NOTE: Proceed to View the Contents of the Log for information on viewing or printing the contents of the log file.

4. After the file has successfully downloaded to your workstation, click **OK** to close the alert box asking you to verify that the software update log file was successfully saved.

View the Contents of the Log

Once the log file has been downloaded to your workstation, you can view its contents.

1. Find the log file in the folder, and right-click in it to open the pop-up menu:

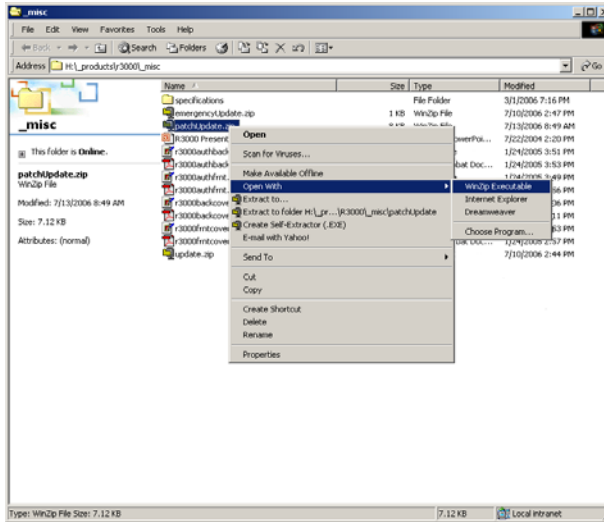

Fig. 2:3-6 Folder containing downloaded file

2. Choose “Open With” and then select a zip file executable program such as “WinZip Executable” to launch that application:

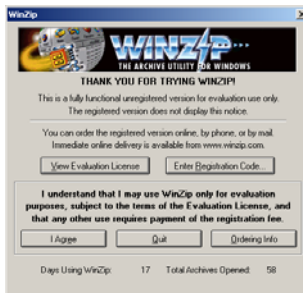

Fig. 2:3-7 WinZip Executable program

3. If using WinZip, click **I Agree** to open the window containing the zip file:

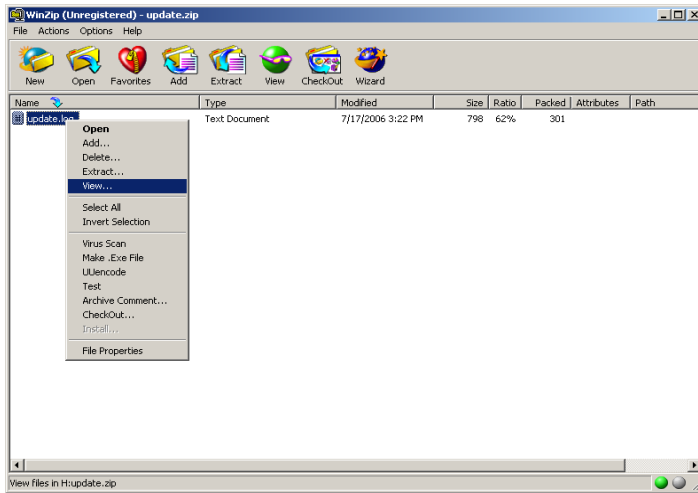

Fig. 2:3-8 WinZip window

4. Right-click the zip file to open the pop-up menu, and choose “View” to open the View dialog box:

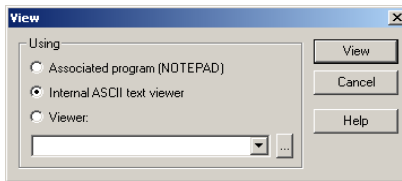

Fig. 2:2-9 View dialog box

5. Select “Internal ASCII text viewer”, and then click **View** to open the View window containing the log file contents:

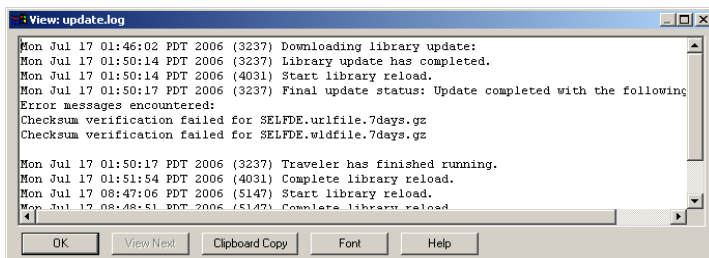

Fig. 2:3-10 View window

Save, Print the Log File Contents

With the log file displaying correctly formatted in WinZip’s View window, if you wish to save or print the contents of this file:

1. Click **Clipboard Copy**, wait for the dialog box to open and confirm that the text has been copied to the clipboard, and then click **OK** to close the dialog box.
2. Open Notepad—in Windows XP: Start > All Programs > Accessories > Notepad
3. Paste the contents from the clipboard into the Notepad file:

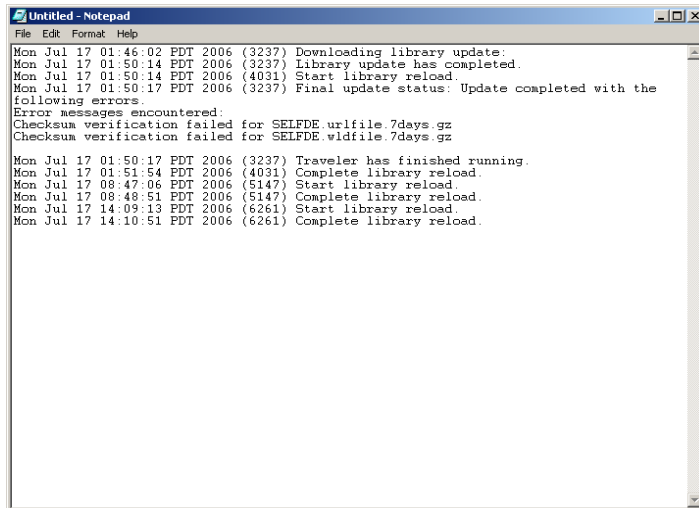

Fig. 2:3-11 Notepad

The correctly formatted Notepad file can now be saved and/or printed.

Emergency Update Log window

The Emergency Update Log window displays when Emergency Update Log is selected from the Updates menu. This window is used for viewing transfer activity of emergency software updates from the update server to your Web Filter, and for downloading the activity log.

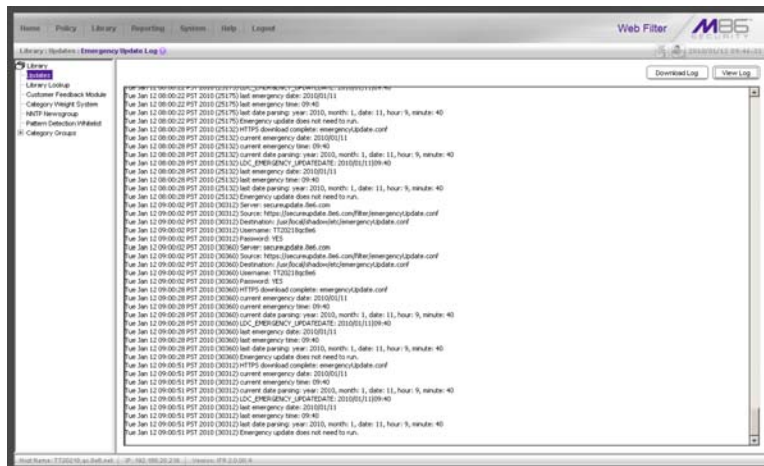

Fig. 2:3-12 Emergency Update Log window

View the Emergency Software Update Process

Click **View Log** to display contents from the emergency software update log file with the status of the software update.

Download the Software Update Log File



NOTE: See *Library Update Log window* for screen shots pertaining to downloading the software update log file.

1. Click **Download Log** to open the alert box containing a message on how to download the log file to your workstation, if using Windows XP.
2. Click **OK** to close the alert box. Two pop-up boxes open:
 - A second alert box asks you to confirm that the file was successfully saved to your machine. Click **OK** in this box after the download is completed.
 - In the file download dialog box, select the “save” option; this action opens the window on your workstation where you specify the filename for the file and where to save the file.
3. Select the folder in which to save the file, and then enter the **File name**, retaining the “.zip” file extension. Click **Save** to begin downloading the zip file to your workstation.
4. After the file has successfully downloaded to your workstation, click **OK** to close the alert box asking you to verify that the software update log file was successfully saved.



NOTE: See *Library Update Log window* for information on viewing the contents of the log file, and printing and/or saving the log file contents.

Library Lookup

Library Lookup window

The Library Lookup window displays when Library Lookup is selected from the navigation panel. This window is used for verifying whether a URL or search engine keyword or keyword phrase exists in a library category, and to remove it, if necessary.

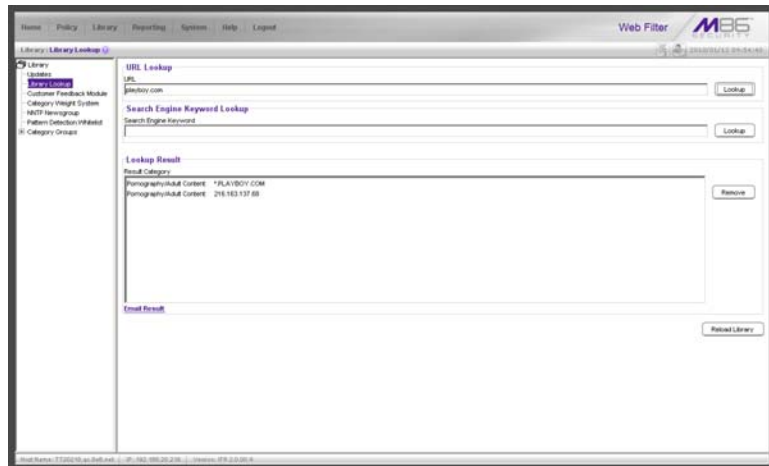

Fig. 2:3-13 Library Lookup window

URL Lookup, Removal

Perform a URL Check

To see if a URL has been included in the library:

1. In the URL Lookup frame, enter the **URL**. For example, enter **http://www.coors.com**, **coors.com**, or use a wildcard by entering ***.coors.com**. A wildcard entry finds all URLs containing text that follows the period (.) after the asterisk (*).

The following types of URL formats also can be entered in this field:

- IP address - e.g. "209.247.228.221" in http://209.247.228.221
- octal format - e.g. http://0106.0125.0226.0322
- hexadecimal short format - e.g. http://0x465596d2
- hexadecimal long format - e.g. http://0x46.0x55.0x96.0xd2
- decimal value format - e.g. http://1180014290
- escaped hexadecimal format - e.g. http://%57%57%57.%41%44%44%49%43%54%49%4E%47%47%41%4D%45%53.%43%4F%4D
- query string - e.g. http://www.youtube.com/watch?v=3_Wfnj1IIMU



NOTES: *The pound sign (#) character is not allowed in this entry. The minimum number of wildcard levels that can be entered is three (e.g. *.yahoo.com) and the maximum number of levels is six (e.g. *.mail.attachments.message.yahoo.com).*

2. Click **Lookup** to open the alert box asking you to wait while the search is being performed.
3. Click **OK** to close the alert box and to display any results in the Result Category list box, showing the long name of the library category, followed by the URL.

Remove a URL

To remove the URL:

1. Select the item from the Result Category list box.
2. Click **Remove**.

Submit an Email to the Administrator

If using a non-Web based email client such as Outlook, you can send an email to the administrator at your organization regarding a URL or search engine keyword that appears to be incorrectly categorized.

1. Select the item(s) from the Result Category list box.
2. Click **Email Result**.

Search Engine Keyword Lookup, Removal

Perform a Search Engine Keyword Check

To see if a search engine keyword or keyword phrase has been included in any library category:

1. In the Search Engine Keyword Lookup frame, enter the **Search Engine Keyword** or keyword phrase, up to 75 alphanumeric characters.
2. Click **Lookup** to display results in the Result Category list box, showing the long name of all categories that contain the search engine keyword/phrase.

Remove a Search Engine Keyword

To remove a search engine keyword/phrase from library categories:

1. After performing the search engine keyword search, select the categories from the Result Category list box.
2. Click **Remove**.

Reload the Library

Once all changes have been made to library windows, click **Reload Library** to refresh.



NOTE: Since reloading the library utilizes system resources that impact the performance of the Web Filter, M86 recommends clicking **Reload Library** only **after** modifications to **all** library windows have been made.

Customer Feedback Module

Customer Feedback Module window

The Customer Feedback Module window displays when Customer Feedback Module is selected from the navigation panel. This window is used for enabling the Customer Feedback Module feature, in which the most frequently visited non-categorized URLs in your Web Filter's filter log will be FTPed to M86 on a daily basis. The URLs collected by M86 will be reviewed and added to M86's standard library categories, as appropriate, so they can be blocked.

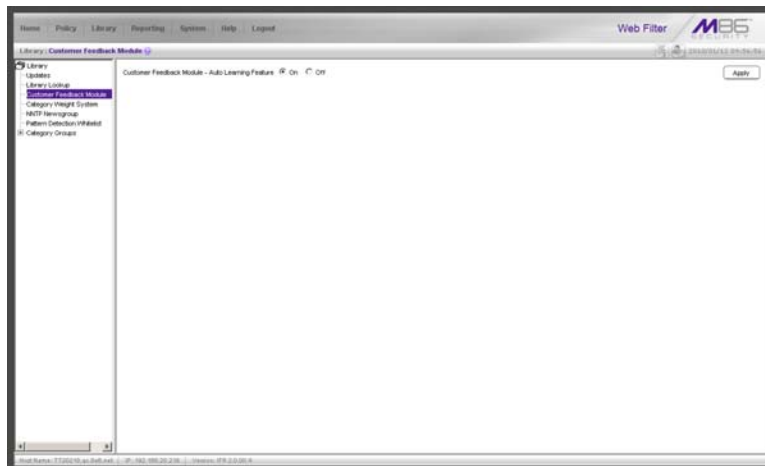

Fig. 2:3-14 Customer Feedback Module window



WARNING: This feature is enabled by default. Please refer to the sub-section *Enable Customer Feedback Module* to review the contents of the disclaimer that applies when this feature is enabled.



NOTE: For optimum results when using this feature, M86 recommends enabling Alert Settings and entering at least one email address that an M86 technical support representative can use to contact you for assistance. (See Alert Settings window in Chapter 1: System screen for information about enabling this feature.)

Disable Customer Feedback Module

1. At the **Customer Feedback Module - Auto Learning Feature** field, click “Off” to indicate that you wish to disable the Customer Feedback Module.
2. Click **Apply**.

Enable Customer Feedback Module

1. At the **Customer Feedback Module - Auto Learning Feature** field, click “On” to indicate that you wish to enable the Customer Feedback Module.
2. Click **Apply** to open the Disclaimer dialog box:

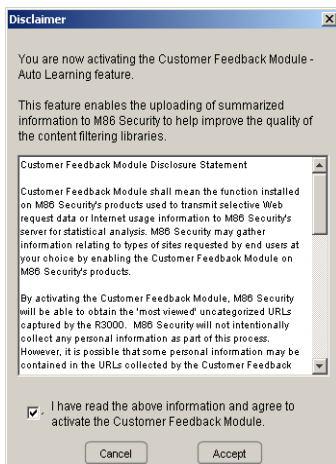

Fig. 2:3-15 Disclaimer box

3. Scroll down to read the text in this box:

“Customer Feedback Module Disclosure Statement

“Customer Feedback Module shall mean the function installed on M86 Security’s products used to transmit selective Web request data or Internet usage information to M86 Security’s server for statistical analysis. M86 Security may gather information relating to types of sites requested by end users at your choice by enabling the Customer Feedback Module on M86 Security’s products.

“By activating the Customer Feedback Module, M86 Security will be able to obtain the ‘most viewed’ uncategorized URLs captured by the Web Filter. M86 Security will not intentionally collect any personal information as part of this process. However, it is possible that some personal information may be contained in the URLs collected by the Customer Feedback Module and sent to M86 Security. At no time will any personal information collected be released publicly, nor will the Web request data be used for any purpose other than enhancing the URL library and related categories used by M86 Security for the purpose of filtering and reporting.

“M86 Security agrees to discuss the information collected by the Customer Feedback Module only with M86 Security’s employees who have a need to know and who have been informed of the confidential nature of the information and of their personal obligation not to disclose or use such information.

“M86 Security may disclose personal Information if, in its sole discretion, M86 Security believes that it is reasonable to do so, including; to satisfy laws, or governmental or legal requests for such information; to disclose information that is necessary to identify, contact, or bring legal action against someone who may be violating M86 Security’s Acceptable Use Policy or other user policies; or to protect M86 Security and its Customers.

“Your agreement to activate the Customer Feedback Module will be transmitted back to M86 Security once you click the ‘Accept’ button.”

4. After reading this text, if you agree with the terms, click in the checkbox to activate the Accept button.
5. Click **Accept** to close the Disclaimer box and to open the Note dialog box:

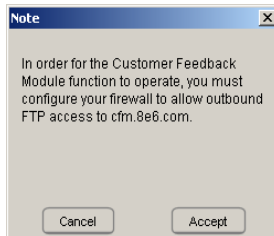

Fig. 2:3-16 Note dialog box

6. If you do not have a firewall, or if you agree to open your firewall to **cfm.8e6.com**, click **Accept** to proceed.

Category Weight System

Category Weight System window

The Category Weight System window displays when Category Weight System is selected from the navigation panel. This feature lets you choose which category will be logged and reported for a URL request that exists in multiple categories (possibly both M86 supplied and custom library categories) with the same operational precedence.

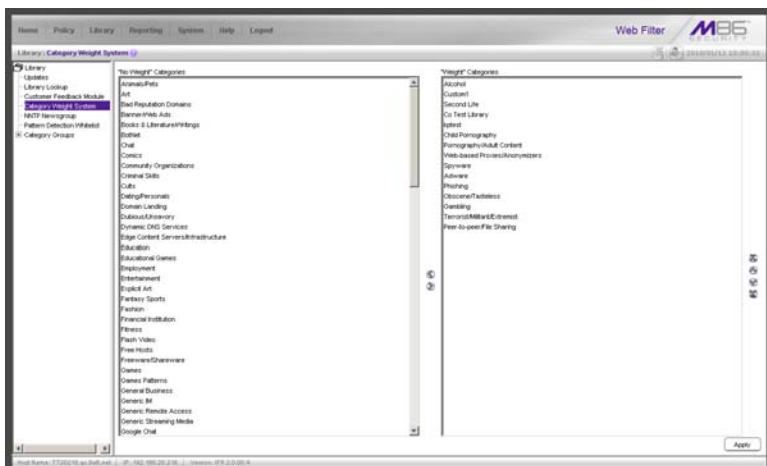

Fig. 2:3-17 Category Weight System window

View the Current Selections

This window contains two list boxes:

- “No Weight” Categories - Populated with M86 supplied categories
- “Weight” Categories - Pre-populated by default with categories M86 suggests you might want to use for this feature.

The contents in each list box, combined with the end user’s profile, help to determine what will appear in the log for the end user’s Internet activity.

Method for Weighting Library Categories

The order of operational precedence is: Always Allowed, Blocked, and Pass.

In the event that an end user attempts to access a URL that exists in multiple categories, the highest operational precedence would be logged.

If a URL exists in a category that is Always Allowed, as well as a category set to be Blocked for that user, Always Allowed would be logged because it holds the highest operational precedence.

However, if an end user attempts to access a URL set to be Blocked in several categories, the category with the highest weighting would be logged.



NOTE: *If a URL exists in multiple un-weighted categories of the same operational precedence, the category logged would be the first one returned by the Web Filter database. Since there is no precedence given, the order in which the category is returned would be random. While it is not necessary to weight all categories, it is recommended that the categories considered a threat should be weighted according to your organization's threat assessment for each category.*

Weighting Library Categories

1. Select the category from the "No Weight" Categories list box.

 **TIP:** Multiple categories can be selected by clicking each category while pressing the Ctrl key on your keyboard. Blocks of categories can be selected by clicking the first category, and then pressing the Shift key on your keyboard while clicking the last category.

2. Use the right arrow to move the selection to the "Weight" Categories list box.

 **TIP:** To remove categories from the "Weight" Categories list box, select the ones you wish to remove and use the left arrow to move them to the "No Weight" Categories list box.

Once the "Weight" Categories list box is populated with categories you wish to include, select a category and use the arrow keys to "weight" it against other categories.

 **TIP:** There are four arrow keys to the right of the "Weight" Categories list box. From top to bottom, the first arrow key moves the selection to the top of the list. The second arrow key moves the selection up one position higher in the list. The third arrow key moves the selection down one position lower in the list. The fourth arrow key moves the selection to the bottom of the list.

3. Click **Apply**. The category positioned at the top of the list will receive the highest "weight" when ranked against other categories, based upon an end user's URL request that appears in multiple library categories set up with the same operational precedence in the end user's filtering profile.

NNTP Newsgroup

NNTP Newsgroup window

The NNTP Newsgroup window displays when NNTP Newsgroup is selected from the navigation panel. This window is used for adding or removing a newsgroup from the libraries.

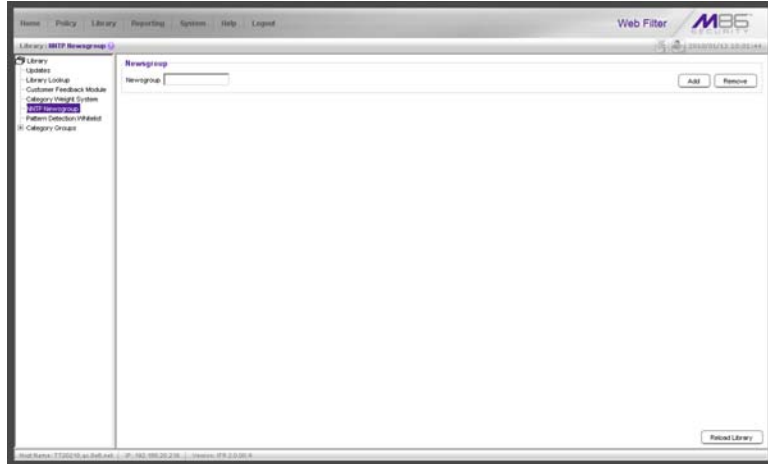

Fig. 2:3-18 NNTP Newsgroup window

Add a Newsgroup to the Library

To add a newsgroup to the library:

1. In the Newsgroup frame, enter the **Newsgroup** address.
2. Click **Add**. If the newsgroup already exists, an alert box will open to inform you that it exists.

Remove a Newsgroup from the Library

To remove a newsgroup from the library:

1. In the Newsgroup frame, enter the **Newsgroup** address.
2. Click **Remove**.

After all changes have been made to library windows, click **Reload Library** to refresh.



NOTE: *Since reloading the library utilizes system resources that impact the performance of the Web Filter, M86 recommends clicking Reload Library only **after** modifications to **all** library windows have been made.*

Pattern Detection Whitelist

Pattern Detection Whitelist window

The Pattern Detection Whitelist window displays when Pattern Detection Whitelist is selected from the navigation panel. This window is used for creating a list of IP addresses always allowed to bypass pattern detection filtering.

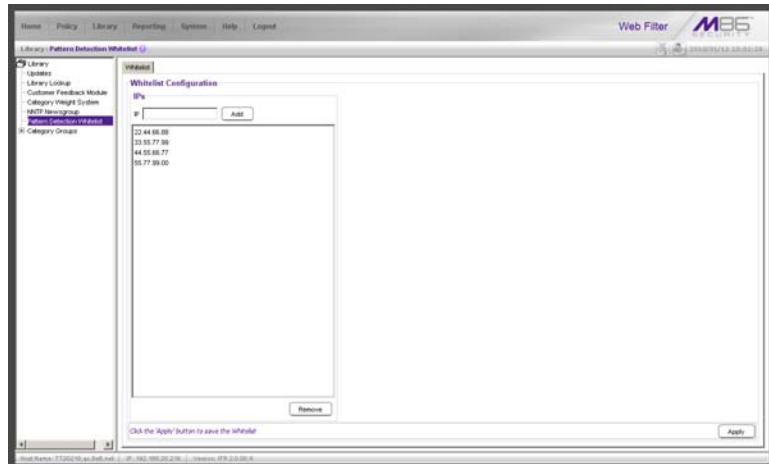

Fig. 2:3-19 Pattern Detection Whitelist window



NOTE: This feature can be used in conjunction with the Pattern Blocking feature, which, when enabled, blocks IP address patterns. (See the Filter window sub-section in Chapter 1: System screen.)

Create, Maintain a Whitelist of IP Addresses

1. Enter the **IP** address to bypass pattern detection filtering.
2. Click **Add** to include the IP address in the IPs list box.



TIP: To remove an IP address from the list, select the IP address from the IPs list box, and then click Remove. Multiple IP addresses can be selected by clicking each IP address while simultaneously pressing down the Ctrl key on the keyboard. A block of IP addresses can be selected by clicking the first IP address in the list, and then pressing down the Shift key on the keyboard while simultaneously clicking the last IP address in the list.

3. After all IP addresses have been added and/or removed, click **Apply**.

Category Groups

Category Groups is represented by a tree of library category groups, with each group comprised of M86 supplied library categories. M86 supplied library categories are updated regularly with new URLs via Traveler, M86's executable program that supplies updates to the Web Filter.

Category Groups also contains the Custom Categories category group. Customized category groups and library categories must be set up and maintained by global or group administrators.

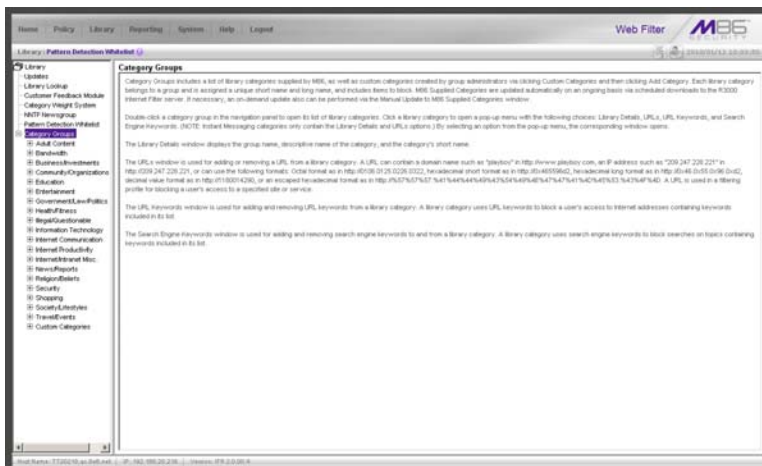

Fig. 2:3-20 Library screen, Category Groups menu



NOTE: See the Custom Categories sub-section of the Group Administrator Section for information on setting up customized category groups and library categories.



WARNING: The maximum number of library categories that can be saved is 512. This figure includes both M86 supplied categories and custom categories.

Double-click Category Groups to open the tree and to display category groups.

Double-click a category group’s envelope to open that segment of the tree and to view library categories belonging to that group.

Click the M86 supplied category link to view a menu of sub-topics: Library Details, URLs, URL Keywords, and Search Engine Keywords. (Menus for Instant Messaging library categories only include the sub-topics Library Details, and URLs).

Library Details window

The Library Details window displays when Library Details is selected from the library category’s menu of sub-topics. This window is a view only window.

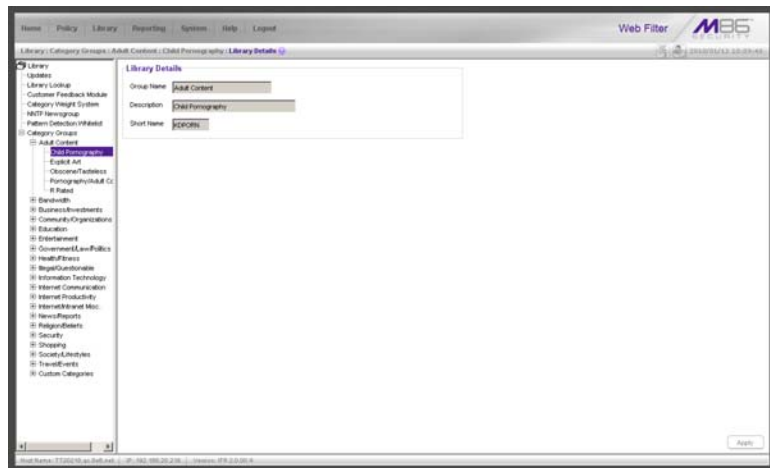

Fig. 2:3-21 Library Details window

View Library Details

This window displays the **Group Name**, **Description**, and **Short Name** of the M86 supplied library category.

URLs window

The URLs window displays when URLs is selected from the library category's menu of sub-topics. This window is used for viewing, or adding and/or removing a URL from a library category. A URL is used in a filtering profile for blocking a user's access to a specified site or service.

A URL can contain a domain name—such as “playboy” in **http://www.playboy.com**—or an IP address—such as “209.247.228.221” in **http://209.247.228.221**. A wildcard asterisk (*) symbol followed by a period (.) can be entered in a format such as ***.playboy.com**, for example, to block access to all URLs ending in “.playboy.com”. A query string can be entered to block access to a specific URL.

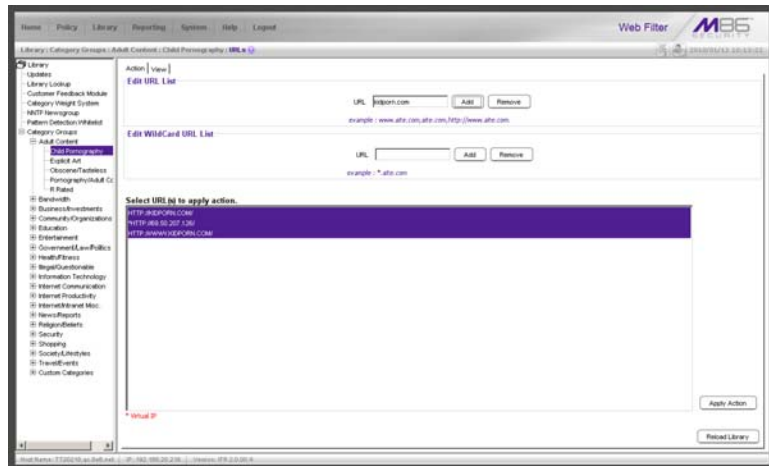

Fig. 2:3-22 URLs window, Action tab

View a List of URLs in the Library Category

To view a list of all URLs that either have been added or deleted:

1. Click the View tab.
2. Make a selection from the pull-down menu for “Addition List”, “Deletion List”, “Wildcard Addition List”, or “Wildcard Deletion List”.
3. Click **View List** to display the specified items in the Select List list box:

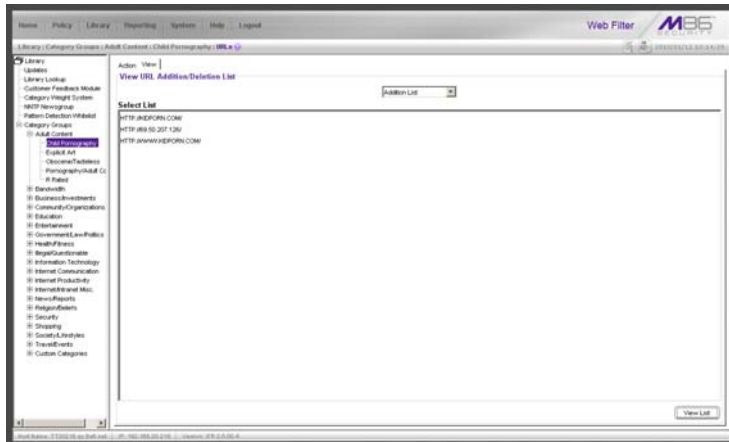

Fig. 2:3-23 URLs window, View tab

Add or Remove URLs, Reload the Library

The Action tab is used for making entries in the URLs window for adding or removing a URL, or reloading the library.

Add a URL to the Library Category

To add a URL to the library category:

1. In the Edit URL List frame, enter the **URL** in a format such as **http://www.coors.com**, **www.coors.com**, or **coors.com**.

The following types of URL formats also can be entered in this field:

- IP address - e.g. "209.247.228.221" in http://209.247.228.221
- octal format - e.g. http://0106.0125.0226.0322
- hexadecimal short format - e.g. http://0x465596d2
- hexadecimal long format - e.g. http://0x46.0x55.0x96.0xd2
- decimal value format - e.g. http://1180014290
- escaped hexadecimal format - e.g. http://%57%57%57.%41%44%44%49%43%54%49%4E%47%47%41%4D%45%53.%43%4F%4D
- query string - e.g. http://www.youtube.com/watch?v=3_Wfnj1IIMU



NOTE: The pound sign (#) character is not allowed in this entry.

2. Click **Add** to display the associated URL(s) in the list box below.
3. Select the URL(s) that you wish to add to the category.

 **TIP:** Multiple URLs can be selected by clicking each URL while pressing the Ctrl key on your keyboard. Blocks of URLs can be selected by clicking the first URL, and then pressing the Shift key on your keyboard while clicking the last URL.

4. Click **Apply Action**.

Add a Wildcard URL to the Library Category

 **NOTE:** Wildcards are to be used for blocking only. They are not designed to be used for the always allowed white listing function.

To add a URL containing a wildcard to the library category:

1. In the Edit WildCard URL List frame, enter the asterisk (*) wildcard symbol, a period (.), and the **URL**.

 **TIP:** The minimum number of levels that can be entered is three (e.g. *.yahoo.com) and the maximum number of levels is six (e.g. *.mail.attachments.message.yahoo.com).

2. Click **Add** to display the associated wildcard URL(s) in the list box below.

3. Select the wildcard URL(s) that you wish to add to the category.

4. Click **Apply Action**.

 **NOTE:** Wildcard URL query results include all URLs containing text following the period (.) after the wildcard (*) symbol. For example, an entry of *.beer.com would find a URL such as http://virtualbartender.beer.com. However, if a specific URL was added to a library category that is **not** set up to be blocked, and a separate wildcard entry containing a portion of that URL is added to a category that **is** set up to be blocked, the end user will be able to access the non-blocked URL but not any URLs containing text following the wildcard. For example, if http://www.cnn.com is added to a category that is not set up to be blocked, and *.cnn.com is added to a category set up to be blocked, the end user will be able to access http://www.cnn.com since it is a direct match, but will not be able to access http://www.sports.cnn.com, since direct URL entries take precedence over wildcard entries.

Remove a URL from the Library Category

To remove a URL or wildcard URL from the library category:

1. Click the Action tab.
2. Enter the **URL** in the Edit URL List frame or Edit Wild-Card URL List frame, as pertinent.
3. Click **Remove** to display the associated URLs in the list box below.
4. Select the URL(s) that you wish to remove from the category.
5. Click **Apply Action**.

Reload the Library

After all changes have been made to library windows, click **Reload Library** to refresh.



NOTE: *Since reloading the library utilizes system resources that impact the performance of the Web Filter, M86 recommends clicking Reload Library only **after** modifications to **all** library windows have been made.*

URL Keywords window

The URL Keywords window displays when URL Keywords is selected from the library category's menu of sub-topics. This window is used for adding and removing URL keywords from a library category. A library category uses URL keywords to block a user's access to Internet addresses containing keywords included in its list.

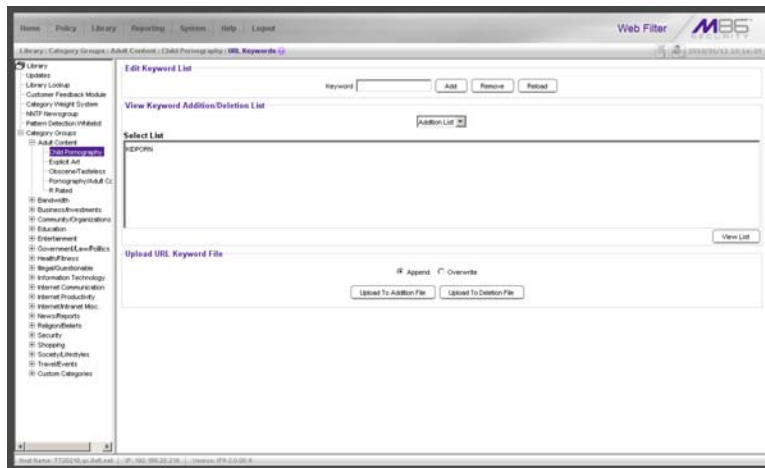

Fig. 2:3-24 URL Keywords window



NOTE: If the feature for URL keyword filtering is not enabled in a filtering profile, URL keywords can be added in this window but URL keyword filtering will not be in effect for the user(s). (See the Filter Options tab in the Policy screen section for information about enabling URL keyword filtering.)



WARNING: Use extreme caution when setting up URL keywords for filtering. If a keyword contains the same consecutive characters as a keyword set up to be blocked, users will be denied access to URLs that are not even within blocked categories. For example, if all URL keywords containing "sex" are blocked, users will not be able to access a non-pornographic site such as <http://www.essex.com>.

View a List of URL Keywords

To view a list of all URL keywords that either have been added or deleted:

1. In the View Keyword Addition/Deletion List frame, make a selection from the pull-down menu for “Addition List”, or “Deletion List”.
2. Click **View List** to display the specified items in the Select List list box.

Add or Remove URL Keywords

Add a URL Keyword to the Library Category

To add a URL keyword to the library category:

1. Enter the **Keyword** in the Edit Keyword List frame.
2. Click **Add**.

Remove a URL Keyword from the Library

To remove a URL keyword from the library category:

1. Enter the **Keyword** in the Edit Keyword List frame.
2. Click **Remove**.

Upload a List of URL Keywords to the Library

Before uploading a text file with URL keyword additions or deletions, in the Upload URL Keyword File frame, specify whether the contents of this file will add to the current file, or overwrite the current file on the server, by clicking the “Append” or “Overwrite” radio button.

Upload a List of URL Keyword Additions

To upload a text file with URL keyword additions:

1. Click **Upload To Addition File** to open the Upload Library Keyword pop-up window:

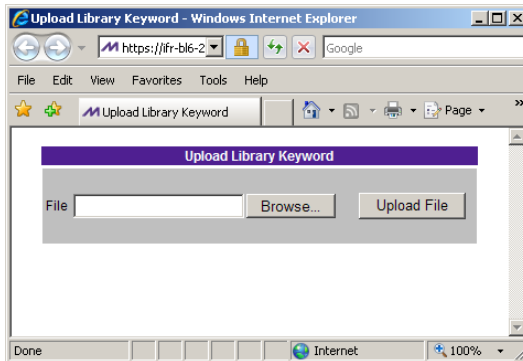

Fig. 2:3-25 Upload Library Keyword pop-up window

2. Click **Browse...** to open the Choose file window.
3. Select the file to be uploaded.
4. Click **Upload File** to upload this file to the server.



NOTE: A URL keyword text file must contain one URL keyword per line.



WARNING: The text file uploaded to the server will overwrite the current file.

Upload a List of URL Keyword Deletions

To upload a text file with URL keyword deletions:

1. Click **Upload To Deletion File** to open the Upload Library Keyword pop-up window (see Fig. 2:3-25).
2. Click **Browse...** to open the Choose file window.
3. Select the file to be uploaded.
4. Click **Upload File** to upload this file to the server.

Reload the Library

After all changes have been made to library windows, click **Reload** to refresh.



NOTE: *Since reloading the library utilizes system resources that impact the performance of the Web Filter, M86 recommends clicking Reload only **after** modifications to **all** library windows have been made.*

Search Engine Keywords window

The Search Engine Keywords window displays when Search Engine Keywords is selected from the library category’s menu of sub-topics. This window is used for adding and removing search engine keywords/phrases to and from a library category. A library category uses search engine keywords to block searches on subjects containing keywords included in its list.

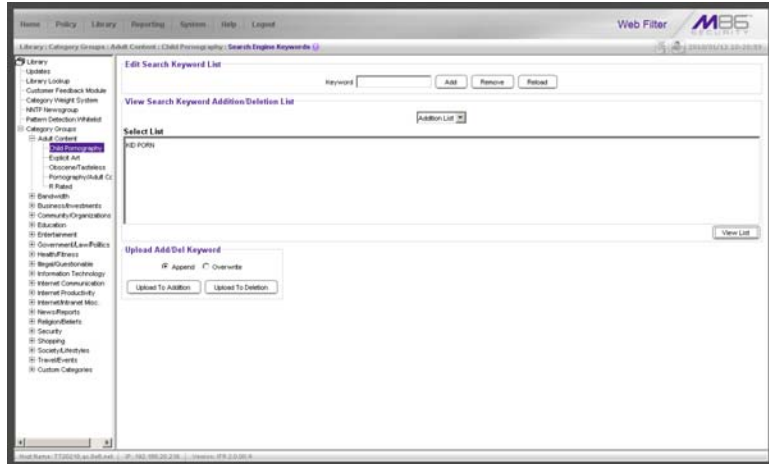

Fig. 2:3-26 Search Engine Keywords window



NOTES: Master lists cannot be uploaded to any M86 supplied library category. See the Custom Categories sub-section of the Group Administrator Section of this user guide for information on uploading a master list to the server.

If the feature for search engine keyword filtering is not enabled in a filtering profile, search engine keywords can be added in this window but search engine keyword filtering will not be in effect for the user(s). (See the Filter Options tab in the Policy screen section for information about enabling search engine keyword filtering.)



WARNING: Use extreme caution when setting up search engine keywords for filtering. If a non-offending keyword contains the same consecutive characters as a keyword set up to be blocked, users will be denied the ability to perform a search using keywords that are not even in blocked categories. For example, if all searches on “gin” are set up to be blocked, users will not be able to run a search on a subject such as “cotton gin”. However, if the word “sex” is set up to be blocked, a search will be allowed on “sexes” but not “sex” since a search engine keyword must exactly match a word set up to be blocked.

View a List of Search Engine Keywords

To view a list of all search engine keywords/phrases that either have been added or deleted:

1. In the View Search Keyword Addition/Deletion List frame, make a selection from the pull-down menu for “Addition List”, or “Deletion List”.
2. Click **View List** to display the specified items in the Select List list box.

Add or Remove Search Engine Keywords

Add a Search Engine Keyword to the Library

To add a search engine keyword/phrase to the library category:

1. In the Edit Search Keyword List frame, enter up to 75 alphanumeric characters in the **Keyword** field.
2. Click **Add**.

Remove a Search Engine Keyword from the Library

To remove a search engine keyword/phrase from the library category:

1. In the Edit Search Keyword List frame, enter up to 75 alphanumeric characters in the **Keyword** field.
2. Click **Remove**.

Upload a List of Search Engine Keywords

Before uploading a text file with search engine keyword/phrase additions or deletions, in the Upload Add/Del Keyword frame, specify whether the contents of this file will add to the current file, or overwrite the current file on the server by clicking the “Append” or “Overwrite” radio button.

Upload a List of Search Engine Keyword Additions

To upload a text file with search engine keyword/phrase additions:

1. Click **Upload To Addition** to open the Upload Library Keyword pop-up window (see Fig. 2:3-25).
2. Click **Browse...** to open the Choose file window. Select the file to be uploaded.
3. Click **Upload File** to upload this file to the server.



NOTE: A search engine keywords text file must contain one keyword/phrase per line.



WARNING: The text file uploaded to the server will overwrite the current file.

Upload a List of Search Engine Keyword Deletions

To upload a text file with search engine keyword/phrase deletions:

1. Click **Upload To Deletion** to open the Upload Library Keyword pop-up window (see Fig. 2:3-25).
2. Click **Browse...** to open the Choose file window. Select the file to be uploaded.
3. Click **Upload File** to upload this file to the server.

Reload the Library

After all changes have been made to library windows, click **Reload** to refresh.



NOTE: *Since reloading the library utilizes system resources that impact the performance of the Web Filter, M86 recommends clicking Reload only **after** modifications to **all** library windows have been made.*

Chapter 4: Reporting screen

The Reporting screen contains options for transferring and/ or reviewing Internet usage data collected by the Web Filter.



Fig. 2:4-1 Reporting screen

From the navigation panel at the left of the screen, click Report Configuration to display the Report Configuration window, used if the Web Filter's log files will be transferred to a reporting application. Click Real Time Probe to display windows for configuring and maintaining real time probes. This tool is used for monitoring Internet activities of specified users in real time. If using M86's Security Reporter (SR) or Enterprise Reporter (ER) as the Web Filter's reporting application, click Shadow Log Format to specify the format in which Web Filter logs will be sent to the SR or ER.

 **NOTE:** Information on configuring the Security Reporter (SR) or Enterprise Reporter (ER) to work with the Web Filter can be found in Appendix E of the Appendices Section.

 **WARNING:** A version of the Enterprise Reporter prior to 3.0 should **not** be configured to work with the Web Filter.

Report Configuration

Report Configuration window

The Report Configuration window displays when Report Configuration is selected from the navigation panel. This window is used if a reporting application needs to be set up to receive logs from the Web Filter.

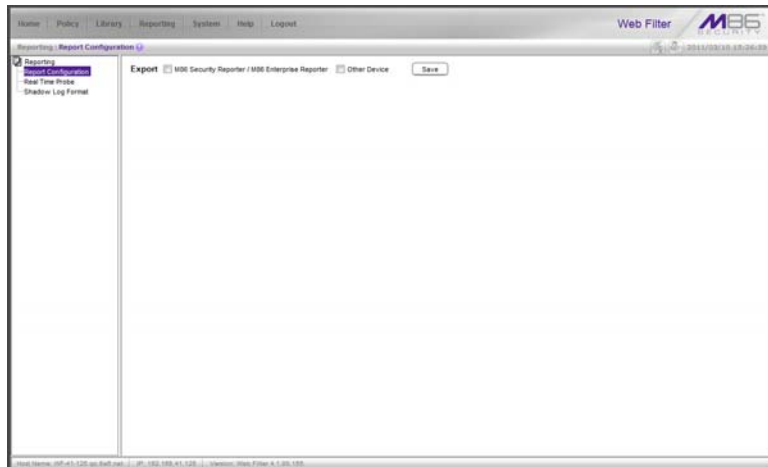

Fig. 2:4-2 Report Configuration window

Specify the Reporting Device

By default, no option is selected at the **Export** field.

If Web Filter logs will be exported to a reporting application:

1. Click the checkbox corresponding to the reporter to be used for transferring logs: “M86 Security Reporter / Enterprise Reporter”, or “Other Device”.
2. Click **Save**.

M86 Security Reporter or Enterprise Reporter

If “M86 Security Reporter / M86 Enterprise Reporter” was selected, the M86 Security Reporter / M86 Enterprise Reporter tab displays by default. On this tab, you need to specify criteria for the SR or ER server that will receive logs from the Web Filter.

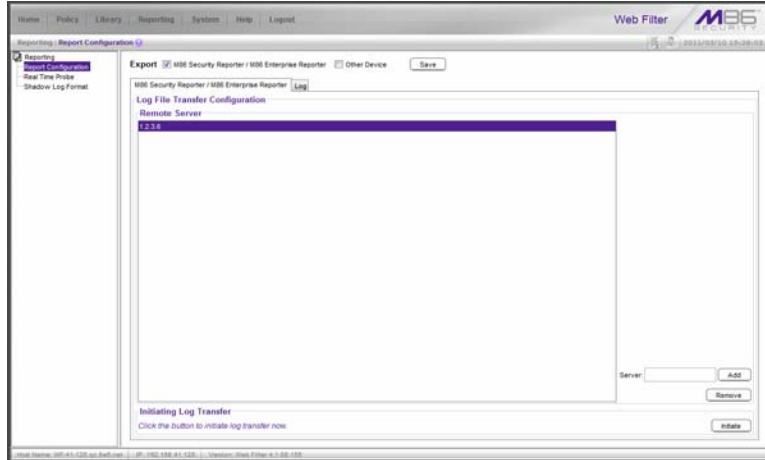

Fig. 2:4-3 Report Configuration window, M86 SR/ER option and tab

Edit SR, ER Server Information

In the Log File Transfer Configuration frame, by default the IP address 1.2.3.6 displays in the Remote Server list box.

To add the IP address assigned to the SR / ER server:

1. Enter the LAN 1 IP address in the **Server** field.
2. Click **Add** to include this IP address in the Remote Server list box.

To remove an IP address from the list box:

1. Select the IP address.
2. Click **Remove**.

Execute Log Transfer Now

In the Initiating Log Transfer frame, click **Initiate** to transfer the log on demand.

View Transfer Activity to the SR, ER

After the SR / ER has been configured and logs have been transferred from the Web Filter to the SR / ER, you can view transfer activity.

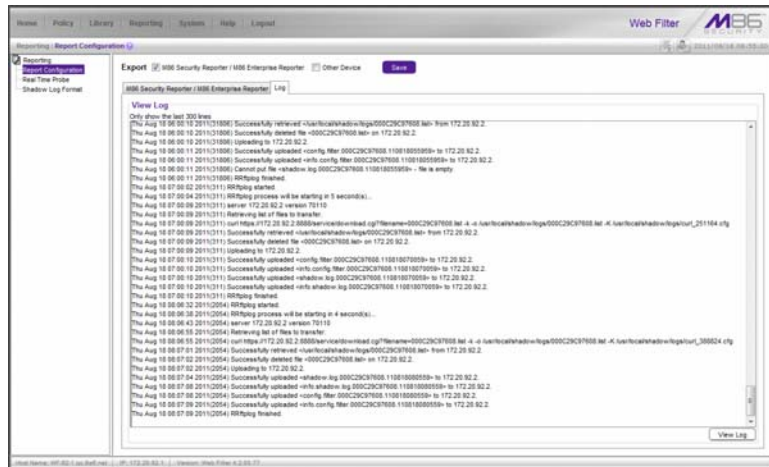

Fig. 2:4-4 Report Configuration window, M86 SR/ER option, Log tab

1. Click the Log tab.
2. Click **View Log** to view up to the last 300 lines of transfer activity in the View Log frame.

Other Device

If “Other Device” was selected, the Other Device tab displays by default. On this tab, you need to specify criteria for the reporter that will receive logs from the Web Filter.

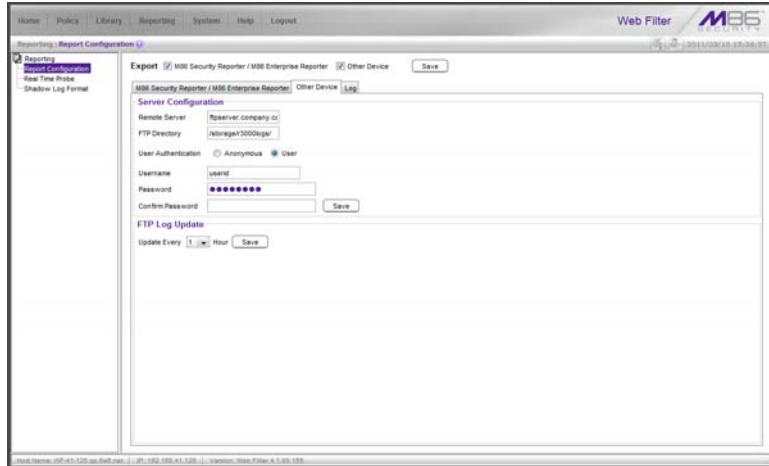

Fig. 2:4-5 Report Configuration window, Other Device option and tab

Enter or Edit Server Information

In the Server Configuration frame:

1. In the **Remote Server** field, enter the IP address of the remote server.
2. In the **FTP Directory** field, enter the path where log files will be stored.
3. At the User Authentication field, “User” is selected by default, indicating that a username and password will be required for FTP transfers. Click the “Anonymous” radio button if no user authentication will be required for FTP transfers.
4. By default, the **Username** field is activated. For this option, *userid* displays by default. Change the username by entering a valid one for FTP transfers.
5. Enter the same password in the **Password** and **Confirm Password** fields.



NOTE: If “Anonymous” is selected, these fields are deactivated.

6. Click **Save**.

In the FTP Log Update frame:

1. At the **Hour** field, make a selection from the pull-down menu (1, 2, 3, 4, 6, 8, 12, 24) to specify the interval between hours—in military time—when the update should occur:
 - 1 = updates occur each hour.
 - 2 = updates occur every two hours, at these intervals of time: 2, 4, 6, 8, 10, 12, 14, 16, 18, 20, 22, 24.
 - 3 = updates occur every three hours, at these intervals of time: 3, 6, 9, 12, 15, 18, 21, 24.
 - 4 = updates occur every four hours, at these intervals of time: 4, 8, 12, 16, 20, 24.
 - 6 = updates occur every six hours, at these intervals of time: 6, 12, 18, 24.
 - 8 = updates occur every eight hours, at these intervals of time: 8, 16, 24.
 - 12 = updates occur every 12 hours, at these intervals of time: 12, and 24.
 - 24 = updates occur every 24 hours.

2. Click **Save**.

View Transfer Activity to the Reporting Device

After logs have been transferred from the Web Filter to the reporting device, the Log tab can be clicked to view transfer activity.

On this tab, click **View Log** to view up to the last 300 lines of transfer activity in the View Log frame.

Real Time Probe

Real Time Probe window

The Real Time Probe window displays when Real Time Probe is selected from the navigation panel. This feature lets the probe administrator monitor a user's Internet usage in real time to see if that user is using the Internet appropriately.

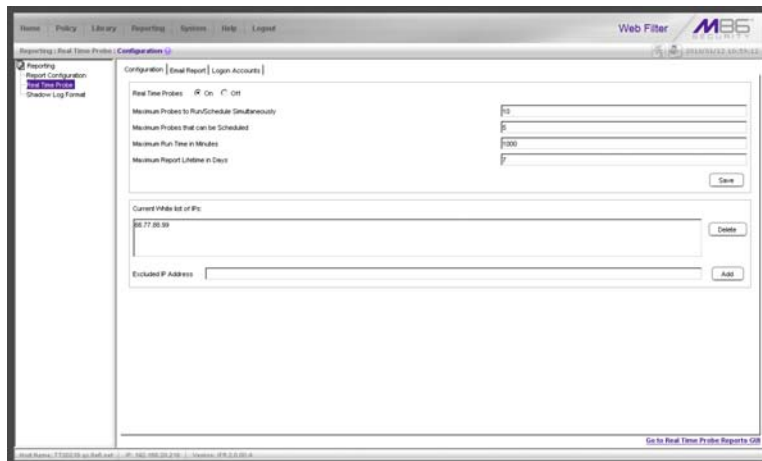

Fig. 2:4-6 Real Time Probe window, Configuration tab

Configuration

Enable Real Time Probes

1. On the Configuration tab, click “On”.
2. Click **Save** to enable the Real Time Probes feature. As a result, all elements in this window become activated.

Set up Real Time Probes

1. Enter the **Maximum Probes to Run/Schedule Simultaneously**, up to 99 probes. The default setting is *10* probes.
2. Enter the **Maximum Probes that can be Scheduled**, equal to or less than the maximum probes that can run at the same time. The default setting is *5* probes.
3. Enter the **Maximum Run Time in Minutes** the probe will search for URLs, up to 1440 minutes (24 hours). The default setting is *1000* minutes.
4. Enter the **Maximum Report Lifetime in Days** to keep a saved report before deleting it. The default setting is *7* days.
5. Click **Save**.

Exclude an IP Address from Real Time Probing

1. Enter the **Excluded IP Address** of a machine to be bypassed from real time probing.
2. Click **Add** to add the IP address in the Current White list of IPs.

Remove IPs from the White List

1. Select the IP address(es) from the Current White list of IPs list box.
2. Click **Delete** to remove the IP address(es) from the white list.

Report Recipients

Click the Report Recipients tab to display Email Report:

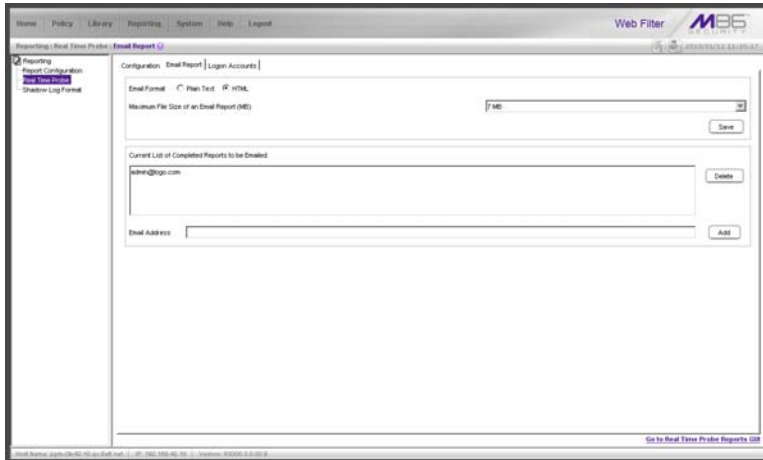

Fig. 2:4-7 Real Time Probe window, Report Recipients tab

Specify Email File Criteria

1. Click the radio button corresponding to the **Email Format** to be used for the file: “Plain Text” or “HTML”. By default, “HTML” is selected.
2. Select the **Maximum File Size of an Email Report (MB)** that can be sent, from 1MB increments up to 20MB. The default is 5 MB.
3. Click **Save**.

Set up Email Addresses to Receive Reports

1. Enter the **Email Address** of an individual who will receive completed probe reports.
2. Click **Add** to include the email address in the Current List of Completed Reports to be Emailed list box.



NOTE: The maximum number of report recipients is 50. If more than 50 recipients need to be included, M86 recommends setting up an email alias list for group distribution.

Remove Email Addresses

1. Select the email address(es) from the Current List of Completed Reports to be Emailed list box.
2. Click **Delete** to remove the email address(es) from list.

Logon Accounts

Click the Logon Accounts tab to display Logon Accounts:

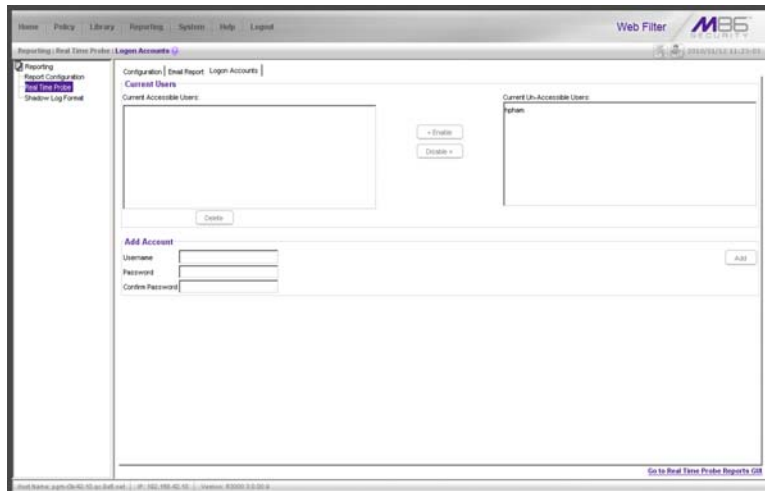

Fig. 2:4-8 Real Time Probe window, Logon Accounts tab

Set up Users Authorized to Create Probes

1. Enter the **Username** of a staff member who is authorized to create real time probes.
2. Enter the user's password in the **Password** and **Confirm Password** fields, using eight to 20 characters and at least one alpha character, one numeric character, and one special character. The password is case sensitive.

3. Click **Add** to include the username in the Current Accessible Users list box.



NOTE: *When an authorized staff member is added to this list, that username is automatically added to the Current Un-Accessible Users list box in the Logon Accounts tab of the X Strikes Blocking window.*

Deactivate an Authorized Logon Account

To deactivate an authorized user's account:

1. Select the username from the Current Accessible Users list box.
2. Click **Disable** to move the username to the Current Un-Accessible Users list box.

Delete a Logon Account

To delete a user's account:

1. Select the username from the Current Accessible Users list box.
2. Click **Delete**.



WARNING: *By deleting a logon account, in addition to not being able to create real time probes, that user will also be removed from the list of users authorized to unlock workstations. (See Chapter 1: System screen, X Strikes Blocking for information on resetting strikes and unlocking workstations.)*

Go to Real Time Probe Reports GUI

When any administrator clicks the Real Time Probe  icon or **Go to Real Time Probe Reports GUI**, either the Re-login window or the Real Time Probe Reports pop-up window opens.

Re-login window

The Re-login window opens if the user's session needs to be validated:

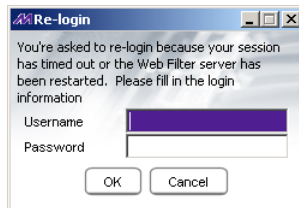

Fig. 2:4-9 Re-login window

1. Enter your **Username**.
2. Enter your **Password**.
3. Click **OK** to close the Re-login window and to re-access the Web Filter console.

Real Time Probe Reports

The Real Time Probe Reports window is comprised of the View and Create tabs. The View tab displays by default (see Fig. 2:4-11), showing the global administrator information on all active probes.



NOTE: An authorized staff member can click a link in an email alert or type in **<https://x.x.x.x:1443/RtProbe.jsp>** in the address field of a browser window—in which “x.x.x.x” is the IP address of the Web Filter—to only see probes he/she created.

When using the aforementioned URL, the following occurs:

- The Login window opens:

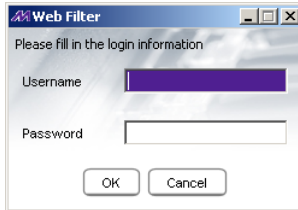

Fig. 2:4-10 Login window

Enter the Username and Password and click **OK** to open the Real Time Probe Reports pop-up window (see Fig. 2:4-11).

- The Web Filter Introductory Window for Real Time Probes simultaneously opens with the Login window:

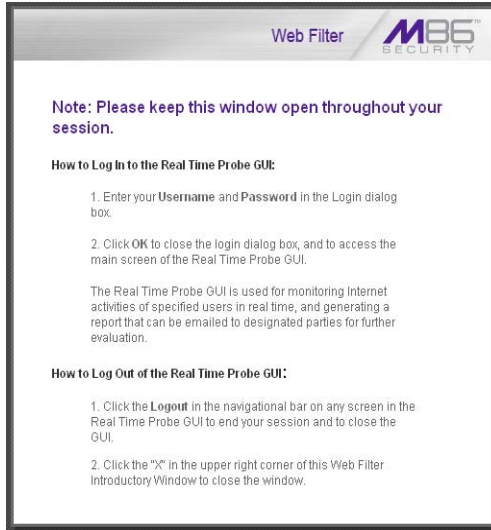

Fig. 2:4-11 Real Time Probes introductory window

This window must be left open during the entire session.

Create a Real Time Probe

Click the Create tab to enter and specify criteria for the report you wish to generate:

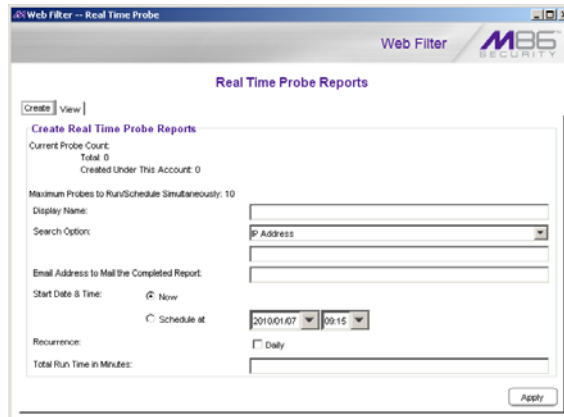

Fig. 2:4-12 Real Time Probe Reports, Create tab

The Current Probe Count displays the Total number of active probes, and the number of probes Created Under This Account. The Maximum Probes to Run/Schedule Simultaneously entered on the Configuration tab displays.

1. Enter up to 40 characters for the **Display Name**. This label will be used for the probe in the View tab and in the email report to be sent to the designated recipient(s).
2. Select the **Search Option**: “IP Address”, “User Name”, “URL”, or “Category”.
3. Enter or specify criteria for the selected Search Option:

- “IP Address”: Enter the IP address to be probed. This selection generates a report with data for the specified IP address.
- “User Name”: Enter the characters to be included in the User Name(s) to be probed. The entry in this field is case-sensitive. This selection generates a report with data for all usernames containing the consecutive characters you specified.

In this example, if **ART** is entered, “ART”, “GARTH”, and “MARTA” would be included in the report. But “Art” or “BARRETT” would not be included, since the former username does not contain all uppercase letters, and the latter username does not contain consecutive characters.

- “URL”: Enter the characters to be included in the URL(s) to be probed. The entry in this field is case-sensitive and the asterisk (*) character is not allowed. This selection generates a report with data for all URLs containing the consecutive characters you specified.

In this example, if **mail** is entered, “http://www.hotmail.com” and “http://loginnet.passport.com/login.srf?id=2&svc=mail&cbid=24325&msspjph=1&tw=0&fs=1&fsa=1&fsat=1296000&lc=1033&_lang=EN” would be included in the report.

- “Category”: Select the library category to be probed. This selection generates a report with data for the specified library category.



TIP: Select “Approved Content” from the drop-down menu to probe instances of the Approved Content online video viewing feature.



NOTE: Up to 250 characters will be accepted for the IP Address, User Name, or URL.

4. If you wish to send the completed report to a specified email address, enter the **Email Address to Mail the Completed Report**.
5. Specify the **Start Date & Time** by clicking the appropriate radio button:
 - “Now” - click this radio button to run the probe now.
 - “Schedule at” - click this radio button to schedule a time for running the probe. Select the date and time from the pull-down menus.

A probe that is scheduled to run at a specified date and time can be scheduled to run on a daily basis by checking the “Daily” checkbox at the **Recurrence** field.
6. Enter the **Total Run Time in Minutes**.
7. Click **Apply**.

View Real Time Probe Details

Click the View tab to view details about active probes:

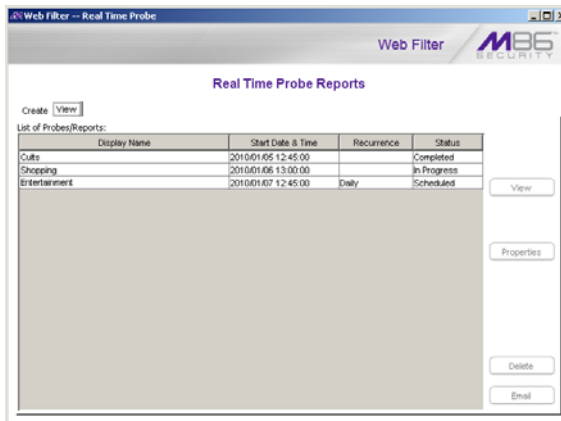

Fig. 2:4-13 Real Time Probe Reports, View tab

The Display Name shows the name assigned to the probe on the Create tab. The Start Date & Time displays in the YYYY/MM/DD HH:MM:SS format. “Daily” displays in the Recurrence column if the probe is scheduled to run on a daily basis. The Status of the probe displays: “Completed”, “In Progress”, or “Scheduled”.

By selecting a probe, buttons for the probe become activated, based on the state of the probe. The following options are available for each of the probe statuses:

- Completed: View, Properties, Delete, Email
- In Progress: View, Properties, Stop
- Scheduled: Properties, Delete

View option

If a probe is Completed or In Progress, clicking **View** opens the Real Time Information window:

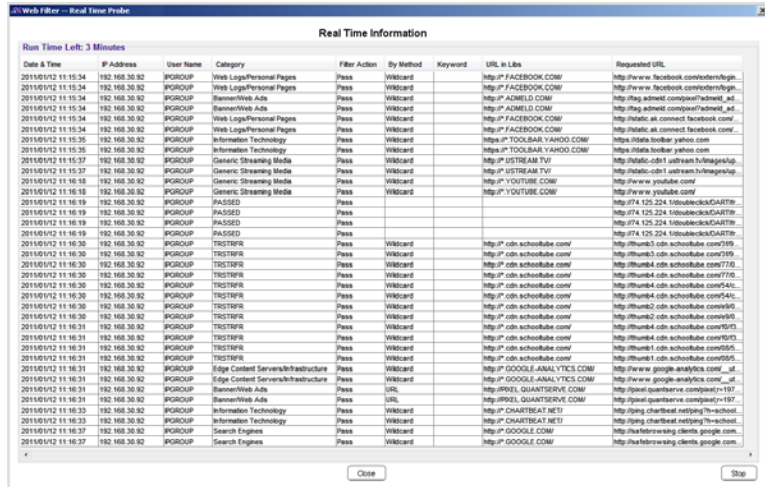

Fig. 2:4-14 Real Time Information window

This window displays the number of minutes left for the probe to run (Run Time Left), and user details for each record in the grid: Date & Time (in the YYYY/MM/DD HH:MM:SS format); IP Address; User Name; library Category (PASSED for any uncategorized sites allowed to pass, and Approved Content if the Approved Content feature is enabled and the record pertains to an approved video), Filter Action set up in the profile (Pass, Block, reserved for ER/SR, Warn, Warned, X Strike, Quota); By Method—the method used in creating the entry (SE Keyword, URL Keyword, URL, Wildcard, Strict HTTPS, Filter Action, Pattern, File Type, Moderate HTTPS); Keyword (displays the matching keyword if the method is an SE Keyword or a URL Keyword); URL in Libraries, and Requested URL.

The following actions can be performed in this window:

- Click a URL to open a window that accesses the designated site.

- If the probe is currently in progress, clicking **Stop** halts the real time probe and changes this button to “Email”.
- After the probe is completed, the Email button is available instead of the Stop button. Clicking **Email** opens the Email option dialog box in which you specify an email address to send the completed report (see Email option).
- Click **Close** to close the Real Time Information window.

Properties option

Clicking **Properties** opens the Probe Properties pop-up box:

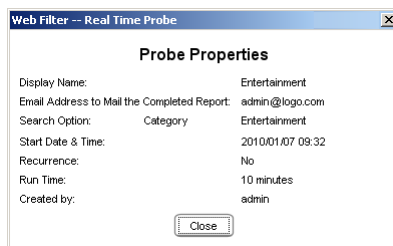

Fig. 2:4-15 Probe Properties pop-up box

This pop-up box includes the following information for the probe: Display Name; Email Address to Mail the Completed Report; Search Option criteria; Start Date & Time; Run Time; and User ID of the creator of the probe (Created by).

Click **Close** to close this pop-up box.

Stop, Delete options

Clicking **Stop** halts the probe and gives it a Completed status. This option is also available in the Real Time Information box via the “Stop” button.

Clicking **Delete** opens the following dialog box, asking if you want to delete the probe:

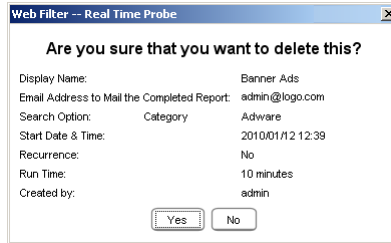

Fig. 2:4-16 Probe Properties deletion box

Click **Yes** to delete the probe and remove it from the View tab.

Email option

Clicking **Email** opens the Email Address box:

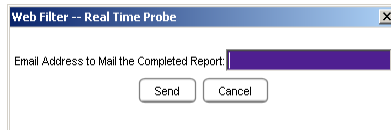

Fig. 2:4-17 Email Address box

Enter the **Email Address to Mail the Completed Report** and click **Send** to send the completed report to the designated email address.

Shadow Log Format

Shadow Log Format window

The Shadow Log Format window displays when Shadow Log Format is selected from the navigation panel. If the Web Filter's reporting device is the M86 Enterprise Reporter (ER), this window is used for specifying the log format the Web Filter will use for sending logs to the ER.

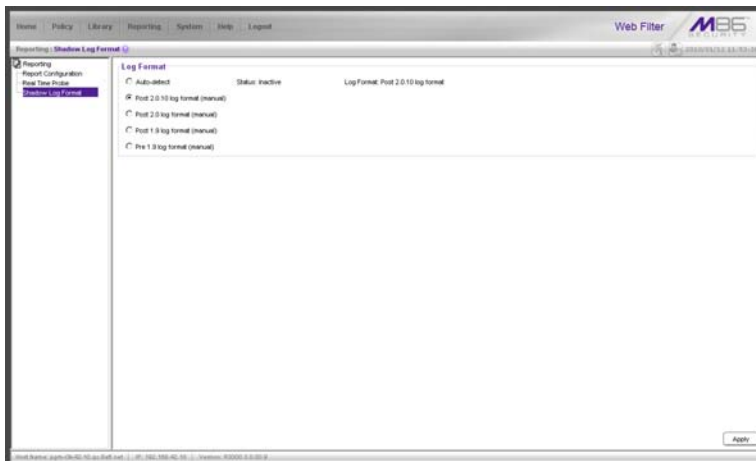

Fig. 2:4-18 Shadow Log Format window

Specify the Shadow Log Format

The window is comprised of the Log Format frame containing radio buttons corresponding to the following options: “Auto-detect”, “Post 2.0.10 log format (manual)”, “Post 2.0 log format (manual)”, “Post 1.9 log format (manual)”, and “Pre 1.9 log format (manual)”.

Auto-detect option

By default, “Auto-detect” is selected. Using this option, the Web Filter will search for a connection to an ER and identify the software version of the software update applied to that appliance.

Status:

- Active - displays by default, or if the ER is using a software version prior to 4.1
- Inactive - displays by default if the ER is using software version 4.1 or later, or if an ER is not connected to the Web Filter

Log Format:

- Post 1.9 log format - displays by default if the ER is using software version 3.75 or later (up until 4.1), or if an ER is not connected to the Web Filter
- Post 2.0 log format - displays by default if the ER is using software version 4.1 or later
- Post 2.0.10 log format - displays by default if the ER is using software version 4.1.20 or later

Post 2.0.10 log format option

If this Web Filter currently has the 2.0.10 or higher software version applied, the Post 2.0.10 log format option should be selected, since the ER 4.1.20 software version uses different logging methods for Medium and High HTTPS filtering.

Post 2.0 log format option

If this Web Filter currently has the 2.0 or higher software update applied, the Post 2.0 log option should be selected, since the ER 4.1 or higher software update uses the new log structure.

Post 1.9 log format option

If this Web Filter currently has the 1.9 or higher software update applied, the Post 1.9 log option should be selected, since the ER 3.75 or higher software update uses the new log structure.

Pre 1.9 log format option

If this Web Filter currently has a software update lower than 1.9 applied, the Pre 1.9 log option should be selected, since ER software updates lower than 3.75 use the original ER log structure.

Apply Setting

Click **Apply** to apply the setting for the shadow log format.

GROUP ADMINISTRATOR SECTION

Introduction

The Group Administrator Section of this user guide is comprised of two chapters that include information on functions performed by the group administrator.

Chapter 1 includes information on setting up and maintaining master IP groups and group members. Chapter 2 includes information on creating and maintaining Custom Categories for libraries.

The group administrator performs the following tasks:

- defines members of a master IP group
- adds sub-group members and/or individual IP members and creates their filtering profiles
- grants designated users access to Internet content blocked at the global level—as appropriate—via an override account and/or exception URL setup
- creates and maintains customized library categories
- uses the lookup tool to remove URLs or search engine keywords from customized libraries

Chapter 1: Policy screen

Group administrators use Policy screen windows to add members to a master IP group, create sub-groups and/or individual IP members, and define and maintain members' filtering profiles. A member is associated with an IP or MAC address (the latter when using the mobile mode) and may contain a netmask within a valid IP address range.

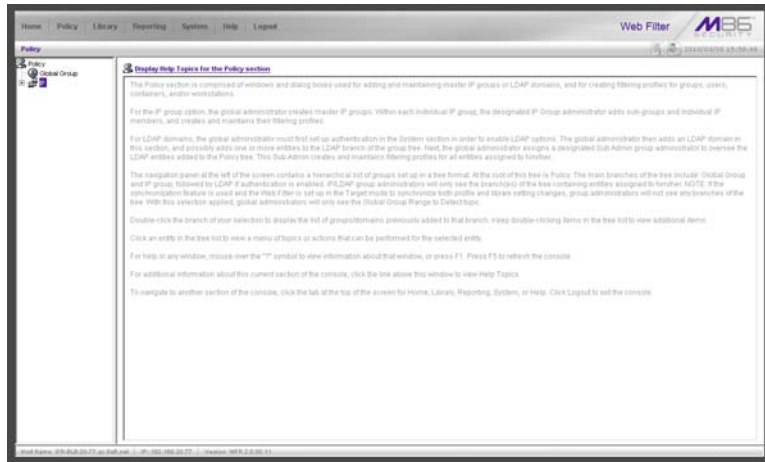

Fig. 3:1-1 Policy screen

The navigation panel at the left of the screen contains the IP branch of the Policy tree.



NOTE: If the synchronization feature is used, a server set up in the Target mode to synchronize both profile and library setting changes will not have branches of the tree accessible.

Double-click the IP branch of the tree to open it and to display the master IP group. Double-click the master IP group to open it and to display any IP sub-groups and/or individual IP members previously set up in the tree list.

Click an entity in the tree list to view a menu of topics or actions that can be performed for that entity.

IP

Refresh

Refresh the Master IP Group, Member

Click Refresh whenever a change has been made to the master IP group or member level of the tree.

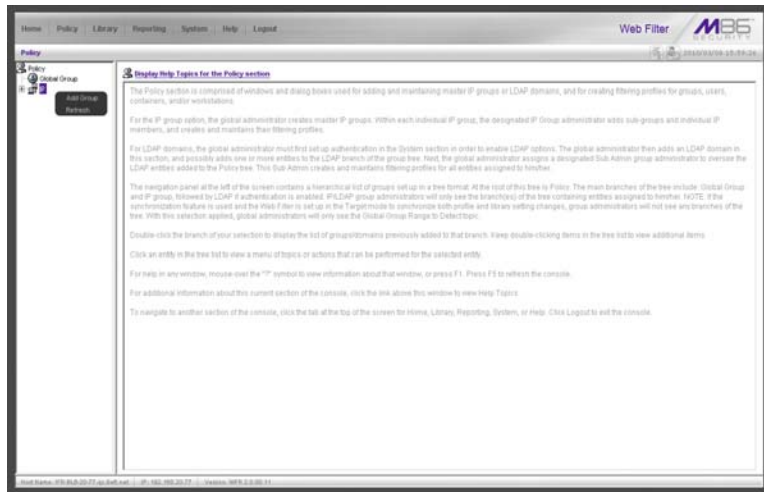

Fig. 3:1-2 Policy screen, IP menu

Master IP Group

Master IP group includes options for defining and maintaining group accounts, setting up an override account and/or exception URLs to bypass global settings, and uploading or downloading IP profiles. Click the master IP group's link to view a menu of sub-topics: Group Details, Members, Override Account, Group Profile, Exception URL, Time Profile, Approved Content (incl. VuSafe), Upload/Download IP Profile, Add Sub Group, Add Individual IP, Delete Group, and Paste Sub Group.

Group Details window

The Group Details window displays when Group Details is selected from the menu. This window is used for viewing the Group Name and for changing the password of the group administrator.

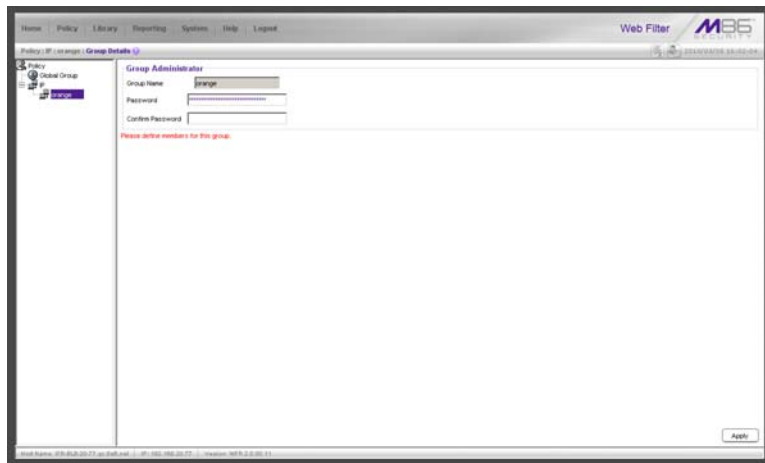

Fig. 3:1-3 Group Details window

Change the Group Administrator Password

In the Group Administrator frame, the **Group Name** displays.

To change the password for this group:

1. Enter the password in the **Password** and **Confirm Password fields**, using eight to 20 characters and at least one alpha character, one numeric character, and one special character. The password is case sensitive.
2. Click **Apply** to apply your settings.

Members window

The Members window displays when Members is selected from the menu. This window is used for adding and managing members of a master IP group. For the invisible and router modes, a member is comprised of an associated IP address, and a sub-group may also contain a netmask. For the mobile mode, a member's MAC address is used for obtaining the end user's filtering profile.



NOTE: See Appendix D: Mobile Client for information on adding members when using the mobile mode.

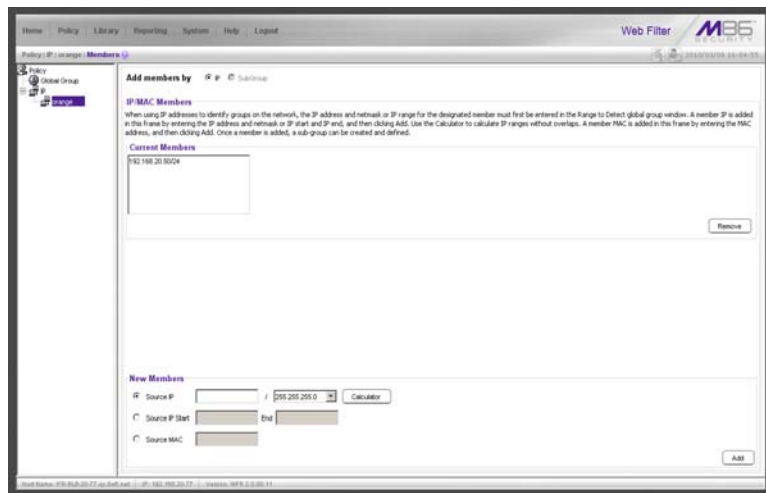

Fig. 3:1-4 Members window

Add the IP Address of the Member

If using the invisible or router mode:

1. Specify whether to add an IP address range with or without a netmask by selecting either “Source IP” or “Source IP Start / End”.
 - If “Source IP” was selected, enter the IP address, and specify the netmask in the **Source IP** fields.
 - If “Source IP Start / End” was selected, enter the **Start** and **End** of the IP address range.
2. Click **Add** to include the IP address entry in the Current Members list box.



TIP: Click **Calculator** to open the IP Calculator, and calculate IP ranges without any overlaps. Enter the **IP** address, specify the **Netmask**, and then click **Calculate** to display results in the Min Host and Max Host fields. Click **Close** to exit.

Remove a Member from the Group

To remove an entry from the Current Members list box:

1. Select the member from the list box.
2. Click **Remove**.

Override Account window

The Override Account window displays when Override Account is selected from the menu. This window is used for creating an override account that allows an end user from a master IP group to bypass settings at the minimum filtering level. A user with an override account will be able to access categories and service ports blocked at the minimum filtering level, if the option to bypass the minimum filtering level is activated.

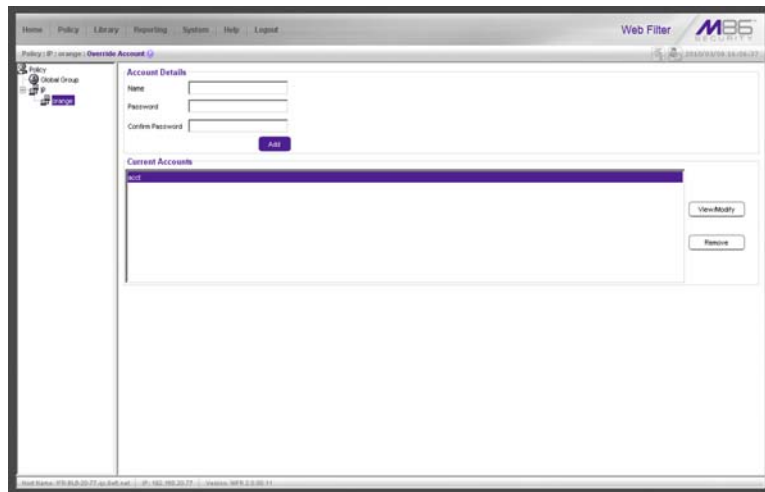

Fig. 3:1-5 Override Account window



NOTES: *Override accounts can be created for any authorized user. In order for a user with an override account to access categories and ports set up to be blocked at the master IP group level, the global administrator must first activate the option to allow an override account to bypass minimum filtering level settings.*

A user can have only one override account. See the Override Account window in Chapter 2 of the Global Administrator Section for information on setting up a global group user's override account.

See Appendix C: Override Pop-up Blockers for information on how a user with an override account can authenticate if a pop-up blocker is installed on his/her workstation.

Add an Override Account

To create an Override Account profile:

1. In the Account Details frame, enter the username in the **Name** field.
2. Enter the **Password**.
3. Make the same entry again in the **Confirm Password** field.
4. Click **Add** to include the username in the list box of the Current Accounts frame, and to open the pop-up window containing the Current Accounts name as well as tabs to be used for specifying the components of the override account profile.
5. Click each of the tabs (Rule, Redirect, Filter Options) and specify criteria to complete the override account profile. (See Category Profile, Redirect URL, and Filter Options in this sub-section for information on the Rule, Redirect, and Filter Options tabs.)
6. Click **Apply** to activate the override account.
7. Click **Close** to close the pop-up window.

Category Profile

The Rule tab is used for creating the categories portion of the override account profile.

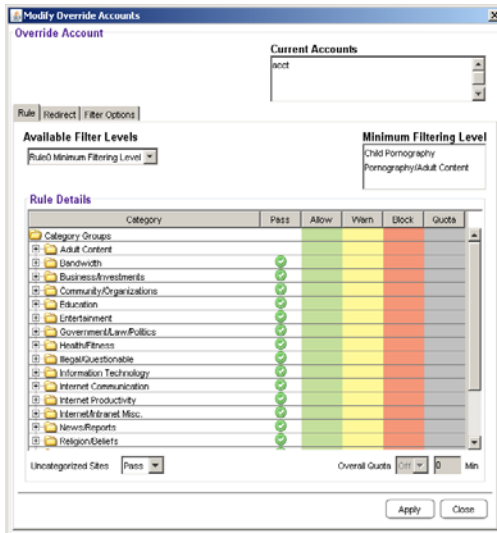

Fig. 3:1-6 Override Account pop-up window, Rule tab

To create the category profile:

1. Select a filtering rule from the available choices in the **Available Filter Levels** pull-down menu. This action automatically populates the Pass, Allow, Warn, and/or Block columns in the Rule Details frame with filter settings for each category group/library category in the Category Groups tree.



TIP: In the Category Groups tree, double-click the group envelope to open that segment of the tree and to view library categories belonging to that group.



NOTE: If a category group does not display any filter setting (i.e. the check mark does not display in any column for the category group), one or more library categories within that group has a filter setting in a column other than the filter setting designated for all collective library categories within that group. For example, if

in the Adult Content category group some of the library categories have a block setting and other library categories have a warn setting, there would be no category group filter setting, since all library categories do not have the same filter setting.

2. To change the filter setting for a category group/library category, double-click the column (Pass, Allow, Warn, Block) in the row corresponding to that category group/library category to move the check mark to that column:
 - **Pass** - URLs in this category will pass to the end user.
 - **Allow** - URLs in this category will be added to the end user's white list.
 - **Warn** - URLs in this category will warn the end user that the URL he/she requested can be accessed, but may be against the organization's policies. The end user can view the URL after seeing a warning message and agreeing to its terms.
 - **Block** - URLs in this category will be blocked.



TIPS: *Multiple categories can be assigned the same filter setting by clicking each category while pressing the Ctrl key on your keyboard, and then double-clicking in the appropriate column.*

Blocks of categories can be assigned the same filter setting by clicking the first category, and then pressing the Shift key on your keyboard while clicking the last category, and then double-clicking in the appropriate column.

3. Make a selection from the **Uncategorized Sites** pull-down menu to specify how to handle a URL that has not yet been categorized: "Pass", "Warn", or "Block".
4. To use the quota feature to restrict the end user's access to a passed library group/category, do the following:

- In the **Quota** column, enter the number of minutes the user will be able to access the library group/category. The minimum number of minutes is “1” and the maximum is “1439” (one day minus one minute). The number of minutes entered here combines with the seconds per hit (minimum one second to maximum 3600 seconds) defined in the Quota Settings window to determine when the end user will be blocked from further access to URLs in that library group/category.



TIP: *If a quota entry is made for a category group, all library categories in that group will show the same number of quota minutes.*



NOTE: *See the Quota Settings window in Chapter 1: System screen for more information on configuring quota settings and resetting quotas for end users currently blocked by quotas.*

- The **Overall Quota** field becomes enabled if a quota is entered for any library group/category. By default, the enabled Overall Quota is turned “Off”. If turned “On”, enter the number of minutes in the **Min** field to indicate when the end user’s access to passed library groups/categories with quotas will be blocked. If the end user spends this amount of time at URLs in any quota-marked library group/category, the Overall Quota overrides the number of minutes defined for each individual quota.
5. Click **Apply** to apply your settings to the override account profile.
 6. Click another tab (Redirect or Filter Options) to continue creating the override account profile, or click **Close** to close the pop-up window and to return to the Override Account window.

Redirect URL

The Redirect tab is used for specifying the URL to be used for redirecting the user if he/she attempts to access a site or service set up to be blocked.

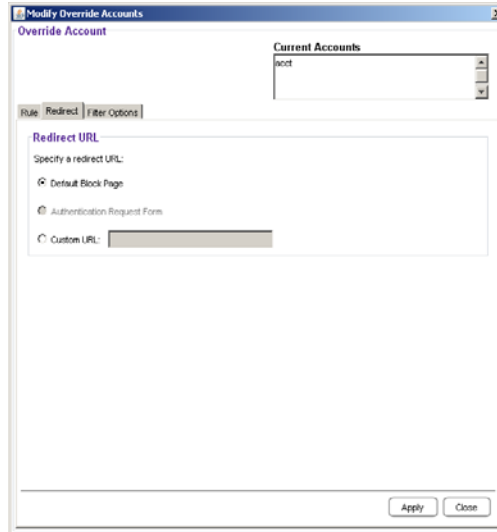

Fig. 3:1-7 Override Account pop-up window, Redirect tab

Specify the type of redirect URL to be used: “Default Block Page”, “Authentication Request Form”, or “Custom URL”.

If “Custom URL” is selected, enter the redirect URL in the corresponding text box. The user will be redirected to the designated page at this URL instead of the block page.

Filter Options

The Filter Options tab is used for specifying which filter option(s) will be applied to the override account profile.

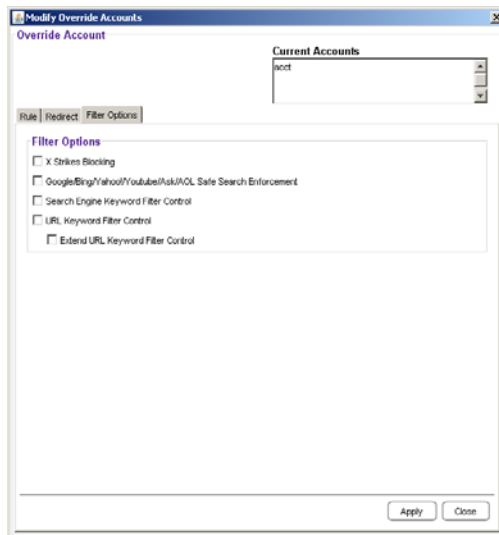

Fig. 3:1-8 Override Account pop-up window, Filter Options tab

Click the checkbox(es) corresponding to the option(s) to be applied to the override account filtering profile:

- “X Strikes Blocking” - With the X Strikes Blocking option enabled, if the user attempts to access inappropriate sites on the Internet, he/she will be locked out from his/her workstation after a specified number of tries within a fixed time period.



NOTE: See the X Strikes Blocking window in Chapter 1: System screen of the Global Administrator Section for information on setting up the X Strikes Blocking feature.

- “Google/Bing/Yahoo!/Youtube/Ask/AOL Safe Search Enforcement” - With the Google/Bing/Yahoo!/Youtube/Ask/AOL Safe Search Enforcement option enabled, Google, Bing.com, Yahoo!, YouTube, Ask.com, and

AOL's "strict" SafeSearch Filtering option will be used whenever the end user performs a Google, Bing.com, Yahoo!, YouTube, Ask.com, or AOL Web search or Image search.



WARNING: *If this option is used in conjunction with the X Strikes Blocking feature and the user is performing an inappropriate Google, Bing.com, Yahoo!, YouTube, Ask.com, or AOL Image search, the number of strikes that user will receive is based upon the amount of time it will take for unacceptable Google, Bing.com, Yahoo!, YouTube, Ask.com, or AOL images returned by the query to load on the page. The user will receive only one strike if all inappropriate images load within the tolerance time range of a given strike.*

- "Search Engine Keyword Filter Control" - With the Search Engine Keyword Filter Control option enabled, search engine keywords can be set up to be blocked. When the user enters a keyword in the search engine, if that keyword has been set up to be blocked, the search will not be performed. Search engine keywords are entered in the Search Engine Keywords window of custom library categories.



NOTE: *To set up search engine keywords in a Search Engine Keywords window, see Search Engine Keywords window in Chapter 2.*

- "URL Keyword Filter Control" - With the URL Keyword Filter Control option enabled, URL keywords can be set up to be blocked. When the user enters a keyword in the address line of a browser window, if that keyword has been set up to be blocked, the user will be denied access to that site or service. URL keywords are entered in the URL Keywords window of custom library categories.

With the "Extend URL Keyword Filter Control" option enabled, a URL keyword search will be extended after the "?" character in a URL.



NOTE: To set up URL keywords in a URL Keywords window, see the URL Keywords window in Chapter 2.

Edit an Override Account

Change the Password

To change an override account's password:

1. In the Current Accounts frame, select the username from the list box.
2. In the Account Details frame, enter the username in the **Name** field.
3. Enter the new **Password**.
4. Make the same entry again in the **Confirm Password** field.
5. Click **View/Modify** to open the pop-up window.
6. Click **Apply**.
7. Click **Close** to close the pop-up window.

Modify an Override Account

To modify an override account:

1. In the Current Accounts frame, select the username from the list box.
2. Click **View/Modify** to open the pop-up window.
3. Click the tab in which to make modifications (Rule, Redirect, Filter Options).
4. Make your edits in this tab and in any other tab, if necessary.
5. Click **Apply**.
6. Click **Close** to close the pop-up window.

Delete an Override Account

To delete an override account:

1. In the Current Accounts frame, select the username from the list box.
2. Click **Remove**.

Group Profile window

The Group Profile window displays when Group Profile is selected from the group menu. This window is used for viewing/creating the group's filtering profile. Click the following tabs in this window: Category, Redirect URL, and Filter Options. Entries in these tabs comprise the profile string for the group.



NOTE: *The Group Profile window is similar to the Sub Group Profile window and the Individual IP Profile window, except the latter windows are configured and maintained by the group administrator.*

Category Profile

Category Profile displays by default when Group Profile is selected from the group menu, or when the Category tab is clicked. This tab is used for assigning filter settings to category groups/library categories for the group's filtering profile.

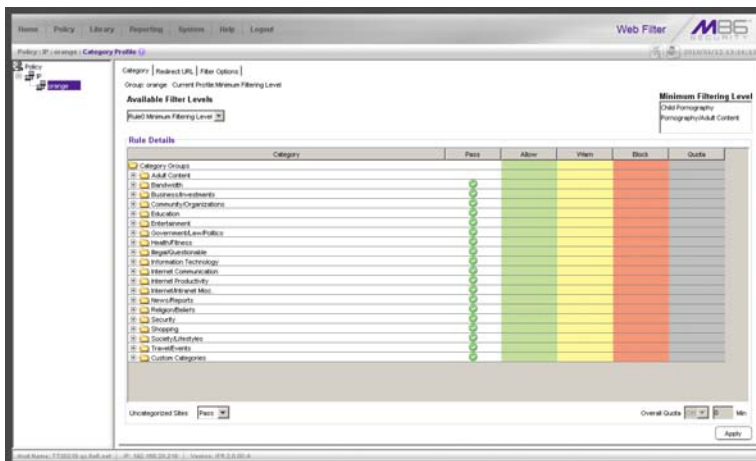



Fig. 3:1-9 Group Profile window, Profile tab

 **NOTE:** In order to use this tab, filtering rules profiles must already have been set up by the global administrator.

By default, “Rule0 Minimum Filtering Level” displays in the **Available Filter Levels** pull-down menu, and the Minimum Filtering Level box displays “Child Pornography” and “Pornography/Adult Content”. By default, **Uncategorized Sites** are allowed to Pass.

 **NOTE:** By default, the Available Filter Levels pull-down menu also includes these five rule choices: Rule1 BYPASS”, “Rule2 BLOCK Porn”, “Rule3 Block IM and Porn”, “Rule4 M86 CIPA Compliance”, and “Rule5 Block All”.

Create, Edit a List of Selected Categories

To create the category profile:

1. Select a filtering rule from the available choices in the **Available Filter Levels** pull-down menu. This action automatically populates the Pass, Allow, Warn, and/or Block columns in the Rule Details frame with filter settings for each category group/library category in the Category Groups tree.

 **TIP:** In the Category Groups tree, double-click the group envelope to open that segment of the tree and to view library categories belonging to that group.

 **NOTE:** If a category group does not display any filter setting (i.e. the check mark does not display in any column for the category group), one or more library categories within that group has a setting in a column other than the filter setting designated for all collective library categories within that group. For example, if in the Adult Content category group some of the library categories have a block setting and other library categories have a warn setting, there would be no category group filter setting, since all library categories do not have the same filter setting.

2. To change the filter setting for a category group/library category, double-click the column (Pass, Allow, Warn, Block) in the row corresponding to that category group/library category to move the check mark to that column:
 - **Pass** - URLs in this category will pass to the end user.
 - **Allow** - URLs in this category will be added to the end user's white list.
 - **Warn** - URLs in this category will warn the end user that the URL he/she requested can be accessed, but may be against the organization's policies. The end user can view the URL after seeing a warning message and agreeing to its terms.
 - **Block** - URLs in this category will be blocked.

 **TIPS:** Multiple categories can be assigned the same filter setting by clicking each category while pressing the Ctrl key on your keyboard, and then double-clicking in the appropriate column.

Blocks of categories can be assigned the same filter setting by clicking the first category, and then pressing the Shift key on your keyboard while clicking the last category, and then double-clicking in the appropriate column.

3. Make a selection from the **Uncategorized Sites** pull-down menu to specify how to handle a URL that has not yet been categorized: "Pass", "Warn", or "Block".

4. To use the quota feature to restrict the end user's access to a passed library group/category, do the following:
 - In the **Quota** column, enter the number of minutes the user will be able to access the library group/category. The minimum number of minutes is "1" and the maximum is "1439" (one day minus one minute). The number of minutes entered here combines with the seconds per hit (minimum one second to maximum 3600 seconds) defined in the Quota Settings window to determine when the end user will be blocked from further access to URLs in that library group/category.



TIP: *If a quota entry is made for a category group, all library categories in that group will show the same number of quota minutes.*



NOTE: *See the Quota Settings window in Chapter 1: System screen for more information on configuring quota settings and resetting quotas for end users currently blocked by quotas.*

5. Click **Apply** to apply your settings to the override account profile.
6. Click another tab (Redirect or Filter Options) to continue creating the override account profile, or click **Close** to close the pop-up window and to return to the Override Account window.

Redirect URL

Redirect URL displays when the Redirect URL tab is clicked. This tab is used for specifying the URL to be used for redirecting users who attempt to access a site or service set up to be blocked at the group level.

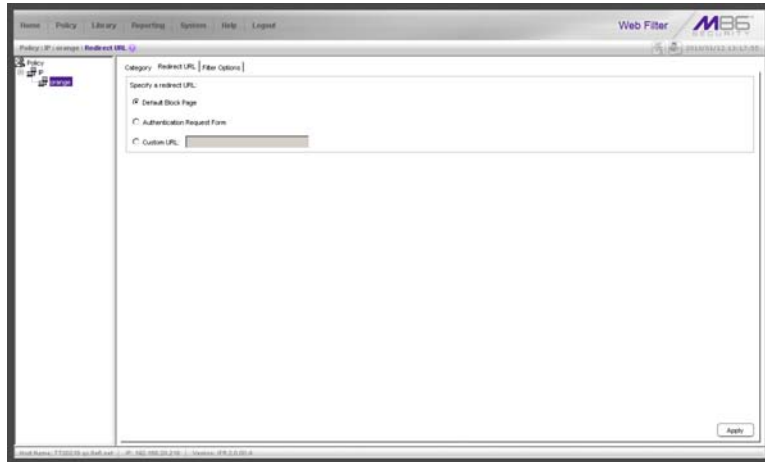

Fig. 3:1-10 Group Profile window, Redirect URL tab

Create, Edit the Redirect URL

1. Specify the type of redirect URL to be used: “Default Block Page”, “Authentication Request Form”, or “Custom URL”.

If “Custom URL” is selected, enter the redirect URL in the corresponding text box. Users will be redirected to the designated page at this URL instead of the block page.

2. Click **Apply** to apply your settings.

Filter Options

Filter Options displays when the Filter Options tab is clicked. This tab is used for specifying which filter option(s) will be applied to the group's filtering profile.

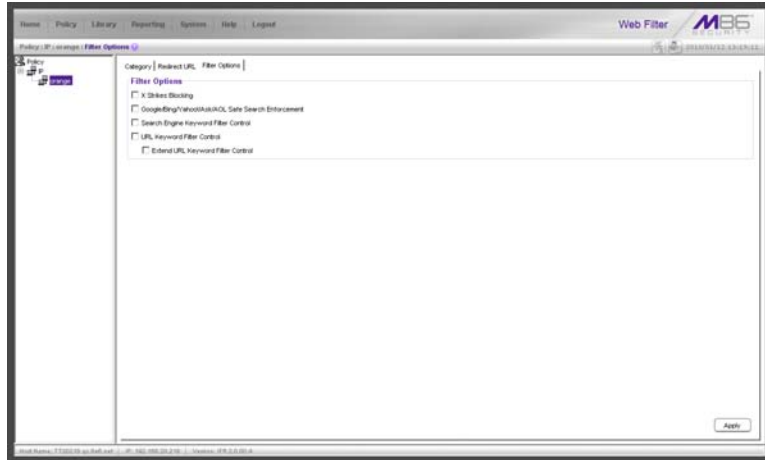

Fig. 3:1-11 Group Profile window, Filter Options tab

Create, Edit the Filter Options

1. Click the checkbox(es) corresponding to the option(s) to be applied to the sub-group filtering profile: “X Strikes Blocking”, “Google/Yahoo!/Youtube/Ask/AOL Safe Search Enforcement”, “Search Engine Keyword Filter Control”, “URL Keyword Filter Control”.
2. Click **Apply** to apply your settings.

X Strikes Blocking

With the X Strikes Blocking option enabled, an end user who attempts to access inappropriate sites on the Internet will be locked out from his/her workstation after a specified number of tries within a fixed time period.



NOTE: See the *X Strikes Blocking* window in Chapter 1: System screen of the Global Administrator Section for information on setting up the *X Strikes Blocking* feature.

Google/Bing/Yahoo!/Youtube/Ask/AOL Safe Search Enforcement

With the Google/Bing/Yahoo!/Youtube/Ask/AOL Safe Search Enforcement option enabled, Google, Bing.com, Yahoo!, YouTube, Ask.com, and AOL's "strict" SafeSearch Filtering option will be used whenever end users perform a Google, Bing.com, Yahoo!, YouTube, Ask.com, or AOL Web search or Image search.



WARNINGS: *This feature is not compatible with the proxy environment as it will cause overblocking.*

An inappropriate image will only be blocked if that image is included in M86's library or is blocked by Google, Bing.com, Yahoo!, YouTube, Ask.com, or AOL.

If this option is used in conjunction with the X Strikes Blocking feature and a user is performing an inappropriate Google, Bing.com, Yahoo!, YouTube, Ask.com, or AOL Image search, the number of strikes that user will receive is based upon the amount of time it will take for unacceptable Google, Bing.com, Yahoo!, YouTube, Ask.com, or AOL images returned by the query to load on the page. The user will receive only one strike if all inappropriate images load within the tolerance time range of a given strike.

Search Engine Keyword Filter Control

With the Search Engine Keyword Filter Control option enabled, search engine keywords can be set up to be blocked. When a user enters a keyword in the search engine, if that keyword has been set up to be blocked, the search will not be performed. Search engine keywords are entered in the Search Engine Keywords window of custom library categories.



NOTES: Search engine keyword filtering relies on an exact keyword match. For example, if the word “sex” is set up to be blocked, but “sexes” is not set up to be blocked, a search will be allowed on “sexes” but not “sex”. However, if the word “gin” is set up to be blocked, a search on “cotton gin” will be blocked since the word “gin” is blocked.

To set up search engine keywords in a Search Engine Keywords window for Custom Categories, see Chapter 2: Library screen, Search Engine Keywords window.

URL Keyword Filter Control

With the URL Keyword Filter Control option enabled, URL keywords can be set up to be blocked. When a user enters a keyword in the address line of a browser window, if that keyword has been set up to be blocked, the user will be denied access to that site or service. URL keywords are entered in the URL Keywords window of custom library categories.

With the “Extend URL Keyword Filter Control” option enabled, a URL keyword search will be extended after the “?” character in a URL.



NOTE: To set up URL keywords in a URL Keywords window for Custom Categories, see Chapter 2: Library screen, URL Keywords window.



WARNING: If this feature is activated, use extreme caution when setting up URL keywords for filtering. If a keyword that is entered in a browser’s address window contains the same consecutive characters as a keyword set up to be blocked, users will be denied access to URLs that are not even within blocked categories. For example, if all URL keywords containing “sex” are blocked, users will not be able to access a non-pornographic site such as <http://www.essex.com>.

Exception URL window

The Exception URL window displays when Exception URL is selected from the group menu. This window is used for blocking group members' access to specified URLs and/or for letting group members access specified URLs blocked at the minimum filtering level.



NOTE: This window is identical to the window by the same name in the Sub Group and Individual IP sections of the Policy tree.

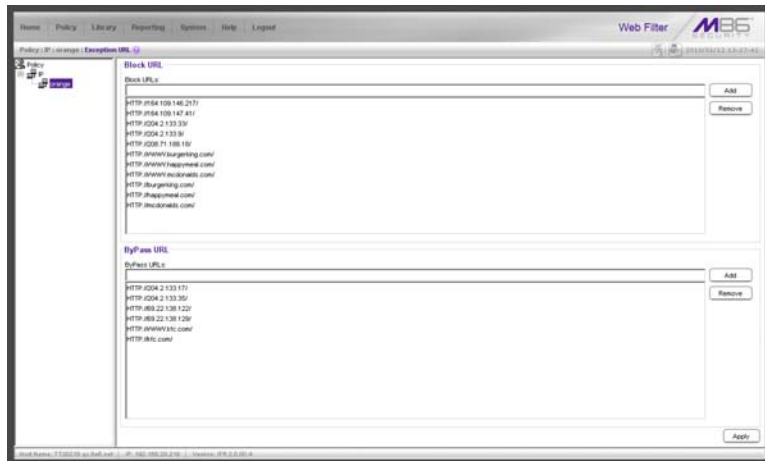

Fig. 3:1-12 Exception URL window



NOTE: Settings in this window work in conjunction with those made in the Override Account window and in the Minimum Filtering Level window maintained by the global administrator. Users with an override account will be able to access URLs set up to be blocked in this window, if the global administrator activates bypass settings in the Minimum Filtering Bypass Options tab. (See the Override Account window in this section for information on setting up an override account to allow a user to bypass group settings and minimum filtering level settings, if allowed.)

Valid URL entries

The following types of URL entries are accepted in this window:

- formats such as: **http://www.coors.com**, **www.coors.com**, or **coors.com**
- IP address - e.g. "209.247.228.221" in http://209.247.228.221
- octal format - e.g. http://0106.0125.0226.0322
- hexadecimal short format - e.g. http://0x465596d2
- hexadecimal long format - e.g. http://0x46.0x55.0x96.0xd2
- decimal value format - e.g. http://1180014290
- escaped hexadecimal format - e.g. http://%57%57%57.%41%44%44%49%43%54%49%4E%47%47%41%4D%45%53.%43%4F%4D
- query string - e.g. http://www.youtube.com/watch?v=3_Wfnj1IIMU



NOTE: The pound sign (#) character is not allowed in this entry.

- case-specific entries - these entries are used by the Approved Content feature that blocks or allows end user accessibility to specific YouTube video URLs
- wildcard entry format that uses an asterisk (*) followed by a period (.) and then the URL, such as: ***.coors.com**



TIP: The minimum number of levels that can be entered for a wildcard entry is three (e.g. *.yahoo.com) and the maximum number of levels is six (e.g. *.mail.attachments.message.yahoo.com).

Add URLs to Block URL or ByPass URL frame

To block or bypass specified URLs, in the Block URL or the ByPass URL frame:

1. Type the URL to be blocked in the **Block URLs** field, or the URL to be bypassed in the **ByPass URLs** field.
2. Click **Add** to open the Add Block URLs / Add Bypass URLs pop-up window to view all corresponding URLs found by the query:

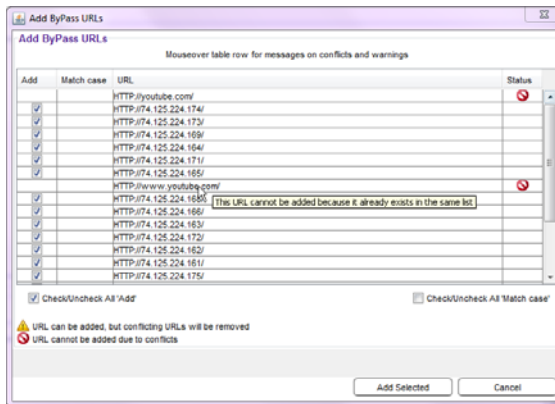



Fig. 3:1-13 Add ByPass URLs pop-up window

This window includes the pre-populated “Add” checkbox preceding each URL in the table. Uncheck any checkbox corresponding to a URL you do not want to include in your list.

 **TIPS:** Click the “Check/Uncheck All ‘Add’” checkbox at the bottom of this window to toggle between selecting or de-selecting all Add column checkboxes in this window.

See the subsequent Status column messages and icons sub-section for information regarding conflicting URLs found by the query.

If a multi-level URL query was executed (as in http://yahoo.com/mail), the Match case column contains an

empty checkbox for each entry in the table. Check the checkbox corresponding to a URL entry you want to designate as being case-specific. The URL entry made by the end user must exactly match this entry in order for the URL to be blocked or bypassed, as set up in this window.



TIPS: Click the “Check/Uncheck All ‘Match case’” checkbox at the bottom of this window to toggle between selecting or de-selecting all Match case column checkboxes in this window.

Click **Cancel** to close this pop-up window without making any selections.

3. Click **Add Selected** to close the pop-up window and to add your selection(s) in the appropriate URL list box.

Status column messages and icons

If conflicting URL entries are found by the query, the following message displays at the top of the query results pop-up window: “Mouseover table row for messages on conflicts and warnings”.

In the Status column of a URL with a conflict, one of two icons displays: either the yellow warning triangle containing an exclamation point, or the red circle with a line through it. Mousing over the affected URL displays a tooltip message indicating the URL already exists in the list, and the type of action that can be performed, if any.

URL conflict types are identified by the legend at the bottom of the pop-up window:

- “URL can be added, but conflicting URLs will be removed” - Preceded by the yellow warning triangle icon containing an exclamation point, this type of conflict indicates the URL entry found by the query is already included in the other frame of the Exception URL window (ByPass URL or Block URL).

- “URL cannot be added due to conflicts” - Preceded by the red circle icon with a line through it, this type of conflict indicates the URL is already included in the Exception URL list.

URL can be added, but conflicting URLs will be removed

When a URL is found in both bypass and block lists, the “Ignore warnings and add URL” checkbox displays to the left of the Add Selected button at the bottom of the pop-up window:

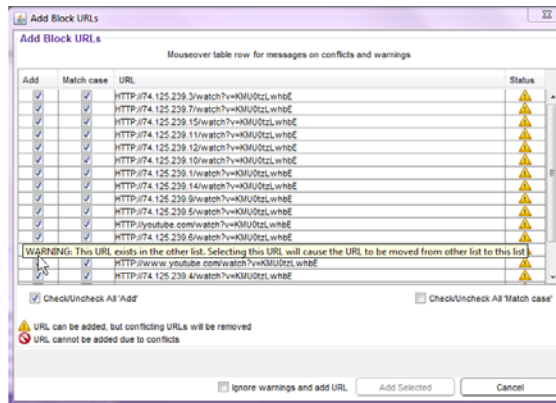

Fig. 3:1-14 Conflicting URLs found by query

Clicking this checkbox activates the Add Selected button. Clicking **Add Selected** closes the pop-up window and moves the selected URLs to the opposite frame in the Exception URL window.

URL cannot be added due to conflicts

If a URL found by the query results is already included in the current list (see Fig. 3:1-13), it will not include a checkbox in the Add column since it cannot be added again.

Remove URLs from Block URL or Bypass URL frame

To remove URLs from the Block URL or the Bypass URL frame:

1. Select a URL to be removed from the Block URL / Bypass URL list box; your selection populates the Block URLs field / Bypass URLs field.

 **TIP:** Choose a non-IP address URL to maximize results to be returned by the URL query.

2. Click **Remove** to open the Remove Block URLs / Remove Bypass URLs pop-up window to view all corresponding URLs found by the query:

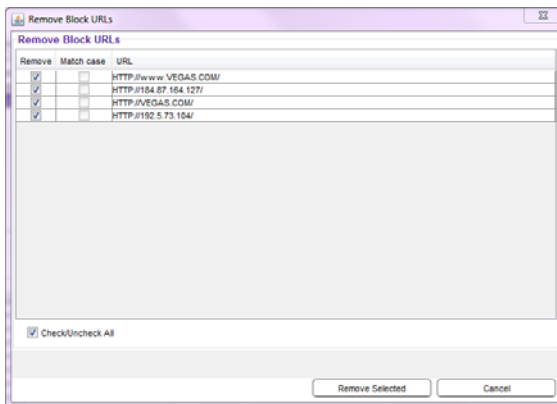



Fig. 3:1-15 Remove Block URLs pop-up window

This window includes the pre-populated “Remove” checkbox preceding each URL in the table. Uncheck any checkbox corresponding to a URL you do not want to remove from your list.

 **TIP:** Clicking the “Check/Uncheck All” checkbox at the bottom of this window toggles between selecting or de-selecting all checkboxes in this window.

3. Click **Remove Selected** to close the pop-up window and to remove your selection(s) from the appropriate URL list box.

Apply Settings

Click **Apply** to apply your settings after adding or removing any URLs.

Time Profile window

The Time Profile window displays when Time Profile is selected from the group menu. This window is used for setting up or modifying a filtering profile to be activated at a specified time.

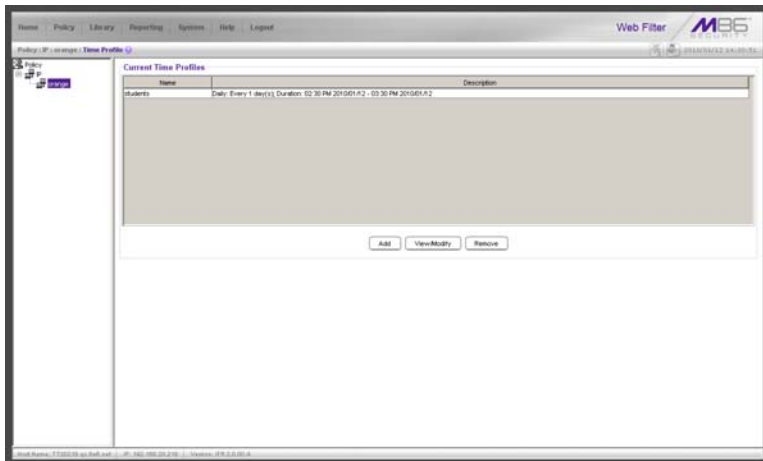

Fig. 3:1-16 Time Profile window

The Current Time Profiles list box displays the Name and Description of any time profiles previously set up for the entity that are currently active.



NOTE: This window is similar to the one used for Sub Group and Individual IP profiles.

Add a Time Profile

To create a time profile:

1. Click **Add** to open the Adding Time Profile pop-up box:

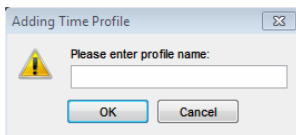

Fig. 3:1-17 Adding Time Profile

2. Type in three to 20 alphanumeric characters—the underscore (`_`) character can be used—for the profile name.
3. Click **OK** to close the pop-up box and to open the Adding Time Profile pop-up window that displays the name of this profile at the top of the Time Profile frame:

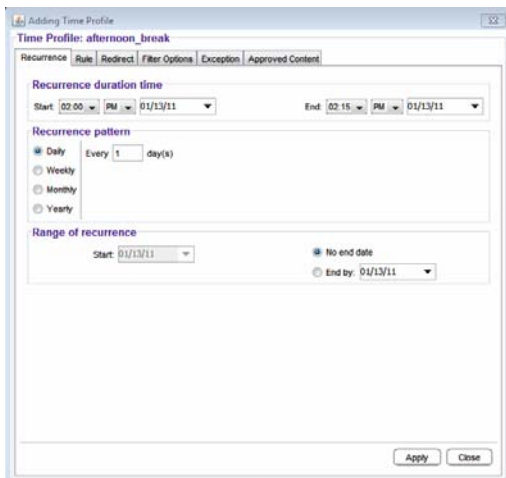

Fig. 3:1-18 Time Profile window Recurrence tab

4. In the Recurrence duration time frame, specify **Start** and **End** time range criteria:

- a. Select from a list of time slots incremented by 15 minutes: “12:00” to “11:45”. By default, the Start field displays the closest 15-minute future time, and the End field displays a time that is one hour ahead of that time. For example, if the time is currently 11:12, “11:15” displays in the Start field, and “12:15” displays in the End field.
- b. Indicate whether this time slot is “AM” or “PM”.
- c. Today’s date displays using the MM/DD/YY format. To choose another date, click the arrow in the date drop-down menu to open the calendar pop-up box:



In this pop-up box you can do the following:

- Click the left or right arrow at the top of this box to navigate to the prior month or the next month.
 - Double-click a date to select it and to close this box, populating the date field with that date.
 - Click **Today** to close this box, populating the date field with today’s date.
5. In the Recurrence pattern frame, choose the frequency this time profile will be used:
 - **Daily** - If this selection is made, enter the interval for the number of days this time profile will be used. By default, “1” displays, indicating this profile will be used each day during the specified time period.

If **5** is entered, this profile will be used every five days at the specified time.

- **Weekly** - If this selection is made, enter the interval for the weeks this time profile will be used, and specify the day(s) of the week (“Sunday” - “Saturday”). By default, “1” displays and today’s day of the week is selected. If today is Tuesday, these settings indicate this profile will be used each Tuesday during the specified time period.

If **2** is entered and “Wednesday” and “Friday” are selected, this profile will be used every two weeks on Wednesday and Friday.

- **Monthly** - If this selection is made, first enter the interval for the months this time profile will be used, and next specify which day of the month:

- If **Day** is chosen, select from “1” - “31”.
- If a non-specific day is chosen, make selections from the two pull-down menus for the following:
 - week of the month: “First” - “Fourth”, or “Last”
 - day of the month: “Sunday” - “Saturday”, “Day”, “Weekday”, “Weekend”.

“By default, “1” displays and today’s Day of the month is selected. If today is the 6th, these settings indicate this profile will be used on the 6th each month during the specified time period.

If **3** is entered and the “Third” “Weekday” are selected, this profile will be used every three months on the third week day of the month. If the month begins on a Thursday (for example, May 1st), the third week day would be the following Monday (May 5th in this example).

- **Yearly** - If this selection is made, the year(s), month, and day for this time profile’s interval must be specified:

First enter the year(s) for the interval. By default “1” displays, indicating this time profile will be used each year.

Next, choose from one of two options to specify the day of the month for the interval:

- The first option lets you choose a specific month (“January” - “December”) and day (“1” - “31”). By default the current month and day are selected.
- The second option lets you make selections from the three pull-down menus for the following:
 - week of the month: “First” - “Fourth”, or “Last”
 - day of the month: “Sunday” - “Saturday”, “Day”, “Weekday”, “Weekend”
 - month: “January” - “December”.

By default, the “First” “Sunday” of “January” are selected.

If **2** is entered and the “First” “Monday” of “June” are selected, this profile will be used every two years on the first Monday in June. For example, if the current month and year are May 2010, the first Monday in June this year would be the 7th. The next time this profile would be used will be in June 2012.

6. In the Range of recurrence frame, the **Start** date displays greyed-out; this is the same date as the Start date shown in the Recurrence duration time frame. Specify whether or not the time profile will be effective up to a given date:
 - **No end date** - If this selection is made, the time profile will be effective indefinitely.
 - **End by** - If this selection is made, by default today’s date displays using the MM/DD/YY format. To choose another date, click the arrow in the date drop-down menu to open the calendar pop-up box. (See the information on the previous pages on how to use the calendar box.)

7. Click each of the tabs (Rule, Redirect, Filter Options, Exception) and specify criteria to complete the time profile. (See Category Profile, Redirect URL, Filter Options, and Exception URL in this sub-section for information on the Rule, Redirect, Filter Options, and Exception tabs.)
8. Click **Apply** to activate the time profile for the IP group at the specified time.
9. Click **Close** to close the Adding Time Profile pop-up window and to return to the Time Profile window. In this window, the Current Time Profiles list box now shows the Name and Description of the time profile that was just added.



WARNING: *If there is an error in a time profile, the Description for that time profile displays in red text. Select that time profile and click **View/Modify** to make any necessary corrections.*

Category Profile

The Rule tab is used for creating the categories portion of the time profile.

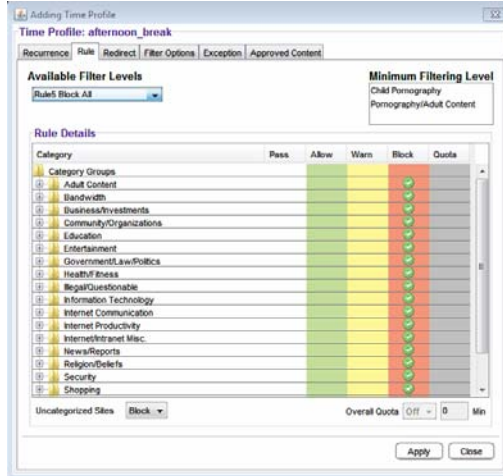

Fig. 3:1-19 Time Profile pop-up window, Rule tab



NOTE: See the *Override Account* window, *Category Profile* subsection in this chapter for information about entries that can be made for this component of the filtering profile.

Redirect URL

The Redirect tab is used for specifying the URL to be used for redirecting users who attempt to access a site or service set up to be blocked.

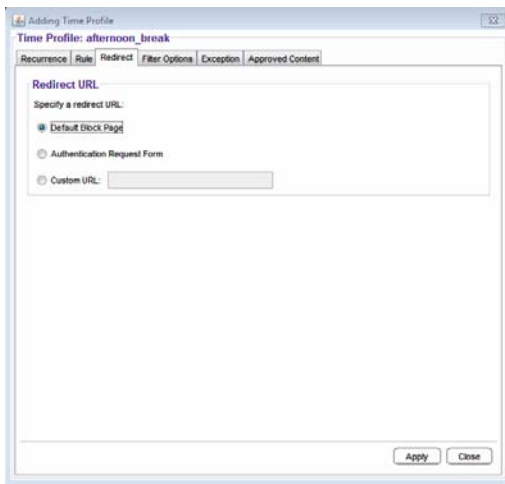

Fig. 3:1-20 Time Profile pop-up window, Redirect URL tab



NOTE: See the *Override Account* window, *Redirect URL* subsection in this chapter for information about entries that can be made for this component of the filtering profile.

Filter Options

The Filter Options tab is used for specifying which filter option(s) will be applied to the time profile.

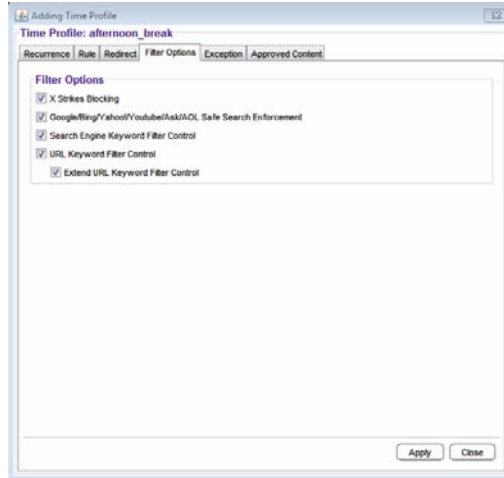

Fig. 3:1-21 Time Profile pop-up window, Filter Options tab



NOTE: See the Override Account window, Filter Options sub-section in this chapter for information about entries that can be made for this component of the filtering profile.

Exception URL

The Exception tab is used for allowing users to be blocked from accessing specified URLs and/or to be allowed to access specified URLs blocked at the minimum filtering level.

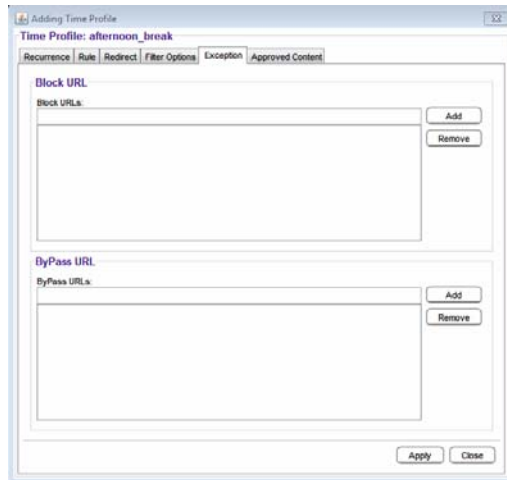

Fig. 3:1-22 Time Profile pop-up window, Exception tab



NOTES: See the Exception URL window sub-section in this chapter for information about entries that can be made for this component of the filtering profile.

Settings in this window work in conjunction with those made in the Override Account window and in the Minimum Filtering Level window maintained by the global administrator. Users with an override account will be able to access URLs set up to be blocked in this window, if the global administrator activates bypass settings in the Minimum Filtering Bypass Options tab. (See the Override Account window in this section for information on setting up an override account to allow a user to bypass group settings and minimum filtering level settings, if allowed.)

Approved Content

The Approved Content tab is used for enabling/disabling the Approved Content feature for users to view specific YouTube or SchoolTube videos from a designated portal or from VuSafe. If this feature is enabled for this profile, passkeys for approved videos are entered in the Passkey list box.

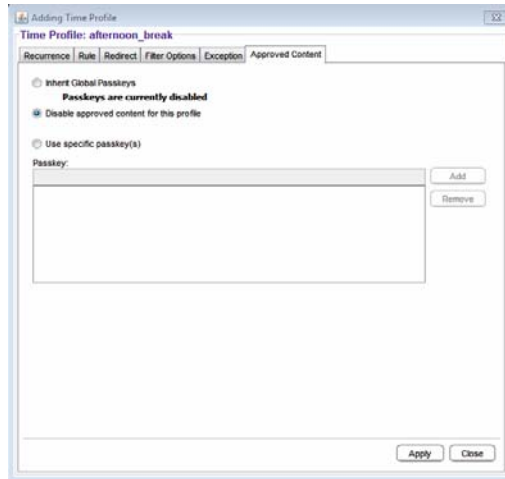



Fig. 3:1-23 Time Profile pop-up window, Approved Content tab

 **NOTE:** See the Approved Content Settings window sub-section in this chapter for information about entries that can be made for this component of the filtering profile.

Modify a Time Profile

To modify an existing time profile:

1. Select the time profile from the Current Time Profiles list box.
2. Click **View/Modify** to open the Modify Time Profiles pop-up window.
3. Make modifications in the default Recurrence tab and/or click the tab in which to make modifications (Rule, Redirect, Filter Options, Exception, Approved Content).
4. Make edits in this tab and in any other tab, if necessary.
5. Click **Apply**.
6. Click **Close** to close the Modify Time Profiles pop-up window, and to return to the Time Profile window.

Delete a Time Profile

To delete a time profile:

1. Select the time profile from the Current Time Profiles list box.
2. Click **Remove**.

Approved Content Settings window

The Approved Content Settings window displays when Approved Content (incl. VuSafe) is selected from the group menu. This window is used for granting users access to a specified set of approved YouTube or SchoolTube videos—via a portal managed by someone within the organization—or videos posted to VuSafe.

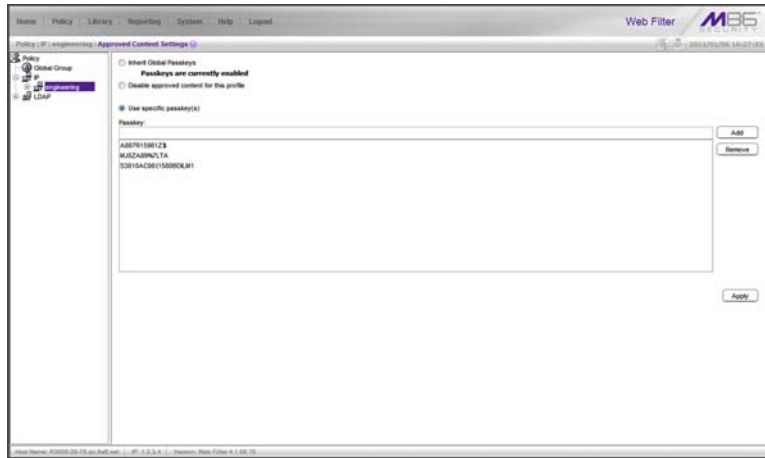

Fig. 3:1-24 Approved Content Settings window



NOTE: See Approved Content Settings window from Chapter 2 of the Global Administrator Section for information about the Approved Content feature and VuSafe.

Approved Content setup and configuration

There are two parts to set up in order to use the Approved Content feature:

- A portal for viewing videos must be created
- The passkey of each approved video must be entered in the Approved Content Settings window for the user's profile



NOTE: If Pattern Blocking is enabled (System > Control > Filter > Service Control frame), then the filtering profile must "Allow" the Flash Video (FLV) pattern (Category Groups > Bandwidth > Streaming Media > Flash Video).

Approved Content portal setup

To create a portal for users to view approved YouTube and/or SchoolTube videos, you will need the following:

- Online Web page or intranet page that you or someone in your organization will maintain for users to view approved videos
- Text editor tool such as Notepad or TextPad
- MD5 checksum calculator tool



NOTE: See the M86 Approved Content Portal Setup document at <http://www.m86security.com/software/8e6/docs/ug/misc/wf.ac.4.1.00.pdf> for instructions on setting up a portal and passkeys for users to view YouTube or SchoolTube videos.

Approved Content Settings entries

1. Choose one of the following options by clicking its corresponding radio button:
 - **Inherit Global Passkeys** - If the Global Group's Approved Content Settings window has the "Enable Approved Content (incl. VuSafe)" option selected, the message "Passkeys are currently enabled" displays in this window. Choosing this option grants this profile access to all videos that have passkeys set up in the Global Group's Passkey list box.

If the Global Group has the “Enable Approved Content (incl. VuSafe)” option disabled, the message “Passkeys are currently disabled” displays, and any passkeys listed for the Global Group will not be inherited by this profile. In this scenario, select either of the other two options, based on whether the Approved Content feature should be disabled or enabled for this profile.

- **Disable approved content for this profile** - Choosing this option disables the Approved Content feature for this profile.
- **Use specific passkey(s)** - Choosing this option lets the profile use passkeys added to the Passkey list box.
To add a passkey to the Passkey list box:
 - a. Enter the case-sensitive, eight to 20 character code in the **Passkey** field.
 - b. Click **Add**.



TIP: To remove a passkey from the list box, select it and then click **Remove**.

2. Click **Apply** to save your entries.

Upload/Download IP Profile window

The IP Profile Management window displays when Upload/Download IP Profile is selected from the group menu. This window is used for uploading or downloading a text file containing filtering profiles of multiple users or sub-groups.

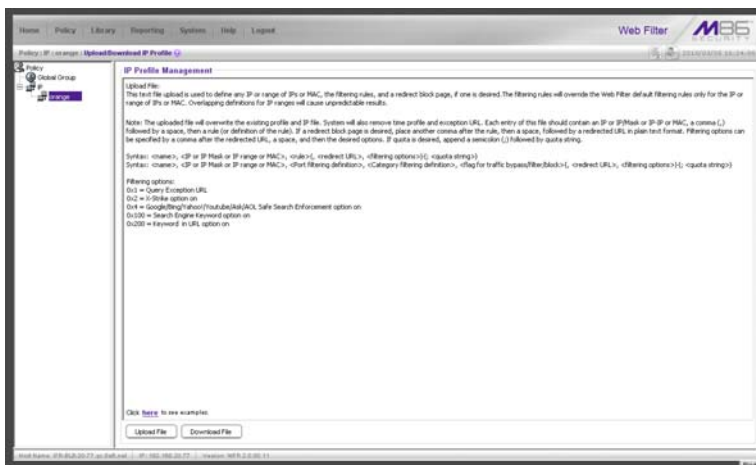

Fig. 3:1-25 IP Profile Management window

Upload IP Profiles

1. Click **Upload File** to open both the refresh message page (see Fig.3:1-27) and the Upload IP Profiles pop-up window:

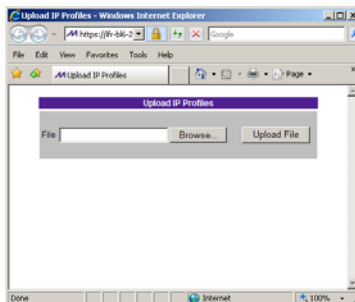



Fig. 3:1-26 Upload IP Profiles pop-up window

 **NOTE:** Leave the refresh page open until the file containing the profile has been uploaded.

2. Click **Browse...** to open the Choose file window in which you find and select the file containing the IP profiles to be uploaded. This text file of user/group profiles must be entered in a specific format.

 **NOTE:** For examples of entries to include in a profile file, go to http://www.m86security.com/software/8e6/hlp/r3000/files/2group_ipprofiles.html

Once the file is selected, the path displays in **File** field.

 **WARNING:** Any existing profiles will be overwritten by the contents of the uploaded file.

3. Click **Upload File** in this pop-up window to display the message “Upload IP Profiles Successfully.”
4. Click the “X” in the upper right corner of the Upload IP Profiles pop-up window to close it.
5. Click **Refresh** in the refresh page to refresh the IP groups branch of the tree:

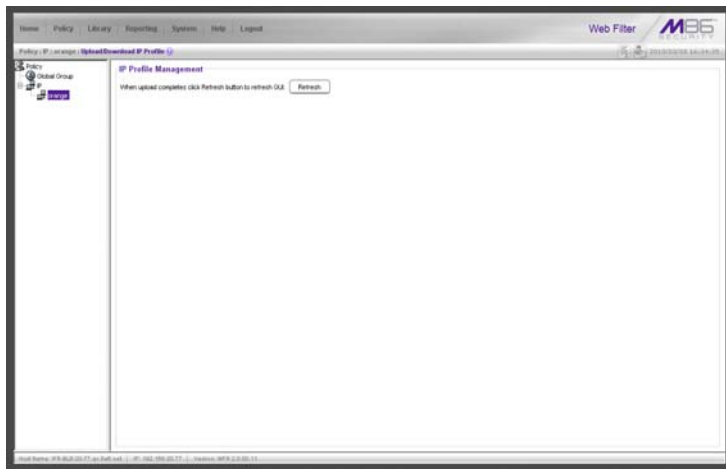

Fig. 3:1-27 Upload IP Profiles refresh page

Download Profile

If profiles have been created and/or uploaded to the server:

1. Click **Download Profile** to open a browser window containing the profiles:

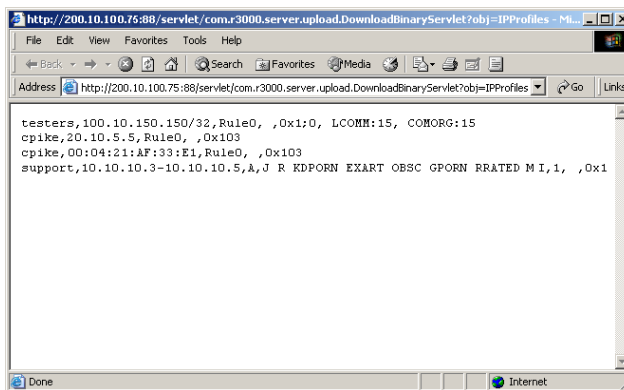

Fig. 3:1-28 Download IP Profiles window

The contents of this window can viewed, printed, and/or saved.

2. Click the “X” in the upper right corner of the window to close it.

Add Sub Group

Add an IP Sub Group

From the group menu:

1. Click Add Sub Group to open the Create Sub Group dialog box:

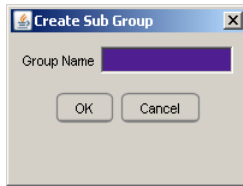

Fig. 3:1-29 Create Sub Group box

2. Enter the **Group Name** for the sub-group.



NOTES: The name of the sub-group must be less than 20 characters; cannot be "IP" or LDAP", and cannot contain spaces. The first character cannot be a digit.

The following characters cannot be used in the name: "." (period), "," (comma), ":" (colon), ";" (semi-colon), "!" (exclamation point), "?" (question mark), "&" (ampersand), "*" (asterisk), "" (quotation mark), "'" (apostrophe), "`" (grave accent mark), "~" (tilde), "^" (caret), "_" (underscore), "|" (pipe), "/" (slash), "\" (backslash), "\\" (double backslashes), "(" (left parenthesis), ")" (right parenthesis), "{" (left brace), "}" (right brace), "[" (left bracket), "]" (right bracket), "@" (at sign), "#" (pound sign), "\$" (dollar sign), "%" (percent sign), "<" (less than symbol), ">" (greater than symbol), "+" (plus symbol), "-" (minus sign), "=" (equals sign).

3. Click **OK** to close the dialog box and to add the sub-group to the master IP group in the Policy tree.



WARNING: When adding a sub-group to the tree list, sub-group users will be blocked from Internet access until the minimum filtering level profile is defined via the Minimum Filtering Level window. The minimum filtering level is established by the global administrator.

Add Individual IP

Add an Individual IP Member

From the group menu:

1. Click Add Individual IP to open the Create Individual IP dialog box:

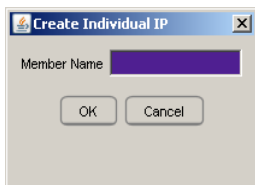

Fig. 3:1-30 Create Individual IP box

2. Enter the **Member Name** for the Individual IP address.



NOTES: The name of the individual IP address must be less than 20 characters; cannot be "IP" or "LDAP", and cannot contain spaces. The first character cannot be a digit.

The following characters cannot be used in the name: "." (period), "," (comma), ":" (colon), ";" (semi-colon), "!" (exclamation point), "?" (question mark), "&" (ampersand), "*" (asterisk), "" (quotation mark), "'" (apostrophe), "`" (grave accent mark), "~" (tilde), "^" (caret), "_" (underscore), "|" (pipe), "/" (slash), "\" (backslash), "\\\" (double backslashes), "(" (left parenthesis), ")" (right parenthesis), "{" (left brace), "}" (right brace), "[" (left bracket), "]" (right bracket), "@" (at sign), "#" (pound sign), "\$" (dollar sign), "%" (percent sign), "<" (less than symbol), ">" (greater than symbol), "+" (plus symbol), "-" (minus sign), "=" (equals sign).

3. Click **OK** to close the dialog box and to add the individual IP member to the master IP group in the Policy tree.



WARNING: When adding an Individual IP member to the tree list, the user will be blocked from Internet access until the minimum filtering level profile is defined via the Minimum Filtering Level window. The minimum filtering level is established by the global administrator.

Delete Group

Delete a Master IP Group Profile

To delete a group profile, choose Delete Group from the group menu. This action removes the master IP group from the tree.

Paste Sub Group

The Paste Sub Group function is used for expediting the process of creating sub-groups, if the sub-group to be added has the same configuration settings as one that already exists.

A sub-group can be “pasted”—or copied—to a group if the Copy Sub Group function was first performed at the sub-group level.

Paste a Copied IP Sub Group

From the group menu:

1. Select Paste Sub Group to open the Paste Sub Group dialog box:

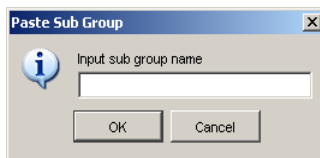

Fig. 3:1-31 Paste Sub Group dialog box

2. In the **Input sub group name** field, enter the name of the sub-group.
3. Click **OK** to add the sub-group to the group in the Policy tree.

Sub Group

Sub Group includes options for creating and maintaining the filtering profile for the sub-group. Click the sub-group's link to view a menu of sub-topics: Sub Group Details, Members, Sub Group Profile, Exception URL, Time Profile, Approved Content (incl. VuSafe), Delete Sub Group, and Copy Sub Group.

Sub Group (IP Group) window

The Sub Group (IP Group) window displays when Sub Group Details is selected from the menu. This window is used for viewing and adding or editing details on an IP group member.

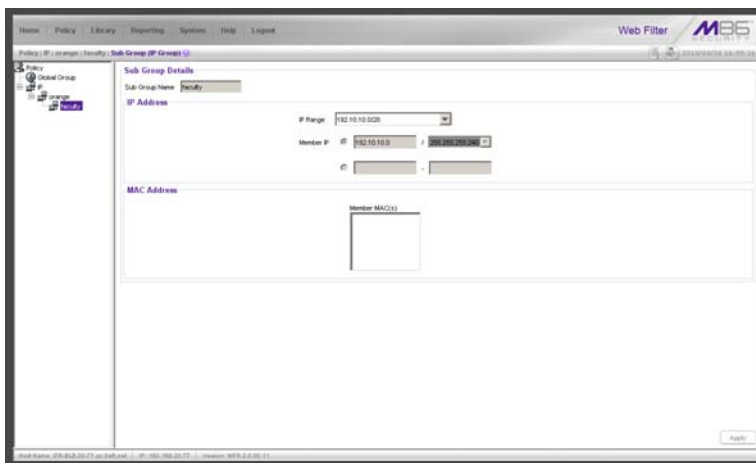



Fig. 3:1-32 Sub Group (IP Group) window, view only

View IP Sub-Group Details

If the sub-group was previously defined, the fields in the Sub Group Details frame cannot be edited. The following information displays:

- Sub Group Name

- IP Range
- Member IP address and netmask or IP address range, and MAC Address(es) if using the mobile mode.

 **NOTE:** See Appendix D: Mobile Client for information on using the mobile mode.

Add IP Sub-Group Details

If the sub-group was not previously defined, the fields in the IP Address frame and the Apply button remain activated.

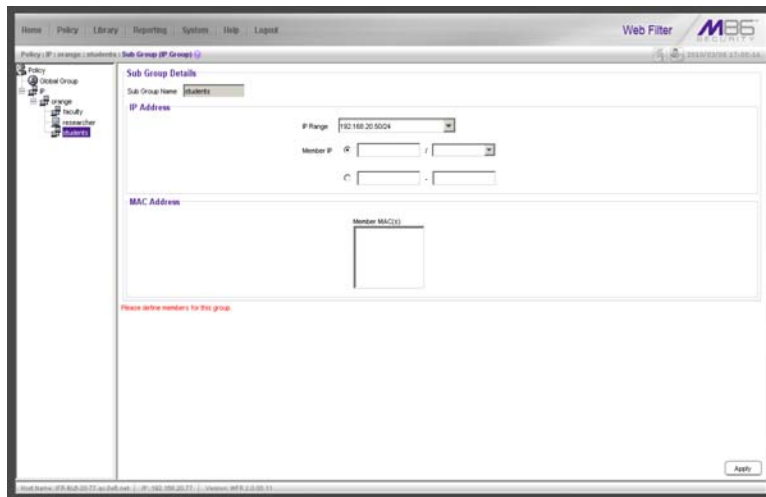



Fig. 3.1-33 Sub Group (IP Group) window, fields activated

1. In the IP Address frame, click the appropriate radio button corresponding to the type of **Member IP** address range to be entered: IP address with netmask, or IP address range.

 **TIP:** Use the IP Range pull-down menu to view the IP address(es) that can be entered in these fields.

2. Corresponding to the selected radio button:
 - enter the IP address and specify the netmask, or

- enter the IP address range in the text boxes.
3. Click **Apply** to save your entries. Once applied, the Member fields become greyed-out and the Apply button becomes deactivated (see Fig. 3:1-32).

Members window

The Members window displays when Members is selected from the menu. This window is used for modifying the sub-group's Member IP address, if using the invisible or router mode. If using the mobile mode, MAC address(es) can be selected for inclusion in the sub-group.



NOTE: See Appendix D: Mobile Client for information on modifying members when using the mobile mode.

The screenshot shows the 'Members' window in the M86 Security Web Filter interface. The window has a navigation menu on the left with 'Members' selected. The main content area is titled 'Add members by' and 'Subgroup'. Below this, there is a section for 'Modify Sub Group Member'. This section contains instructions: 'To add or modify a member IP, enter the IP address and network or IP range in the Member fields. Use the Calculator to calculate IP ranges without any overlaps. To add member MAC(s), highlight the MAC address(es) from the "Available MAC(s)" list and click the left arrow. To remove member MAC(s), highlight the MAC address(es) and click the right arrow. To save changes, click Modify.' The 'IP Address' section has a radio button for 'Member IP' and a 'Calculator' button. Below it are fields for 'Member IP Start' and 'End'. The 'MAC Address' section has two columns: 'Member MAC(s)' and 'Available MAC(s)', with arrows between them. A 'Modify' button is located at the bottom right of the form.

Fig. 3:1-34 Members window

Modify Sub-Group Members

The Modify Sub Group Member frame is comprised of the IP Address and MAC Address frames.

1. In the IP Address frame, specify whether to add or edit an IP address range with or without a netmask by selecting either “Member IP” or “Member IP Start / End”.
 - If “Member IP” was selected, enter the IP address and specify the netmask in the **Member IP** fields.
 - If “Member IP Start / End” was selected, enter the **Member IP Start** and **End** of the IP address range.



TIP: Click **Calculator** to open the IP Calculator, and calculate IP ranges without any overlaps.

2. Click **Modify** to apply your settings.

Sub Group Profile window

The Sub Group Profile window displays when Sub Group Profile is selected from the sub-group menu. This window is used for viewing/creating the sub-group’s filtering profile. Click the following tabs in this window: Category, Redirect URL, and Filter Options. Entries in these tabs comprise the profile string for the sub-group.



NOTE: See the Group Profile window in this chapter for information about entries that can be made for the following components of the filtering profile: Category Profile, Redirect URL, Filter Options.

Exception URL window

The Exception URL window displays when Exception URL is selected from the sub-group menu. This window is used for blocking sub-group members' access to specified URLs and/or for letting sub-group members access specified URLs blocked at the minimum filtering level.



NOTE: See the Exception URL window in the Master IP Group sub-section of this chapter for information on entries that can be made in this window.

Time Profile window

The Time Profile window displays when Time Profile is selected from the sub-group menu. This window is used for setting up or modifying a filtering profile to be activated at a specified time.



NOTE: See the Time Profile window in the Master IP Group sub-section of this chapter for information on entries that can be made for the following components of the filtering profile: Category Profile, Redirect URL, Filter Options, Exception URL, Approved Content.

Approved Content Settings window

The Approved Content Settings window displays when Approved Content (incl. VuSafe) is selected from the sub-group menu. This window is used for granting access to a specified set of approved online videos posted to YouTube or SchoolTube—via a portal managed by someone within the organization—or videos posted to VuSafe.



NOTES: See the *Approved Content Settings window* in Chapter 2 of the *Global Administrator Section* of this user guide for information about the *Approved Content* feature and *VuSafe*.

See the *M86 Approved Content Portal Setup* document at <http://www.m86security.com/software/8e6/docs/ug/misc/wf.ac.4.1.00.pdf> for information on setting up a portal and pass-keys for viewing online YouTube and/or SchoolTube videos. See the *Approved Content Settings window* in the *Master IP Group* sub-section of this chapter for information on entries that can be made in this window.

Delete Sub Group

Delete an IP Sub-Group

To delete a sub-group, choose Delete Sub Group from the sub-group menu. This action removes the sub-group from the tree.

Copy Sub Group

The Copy Sub Group function is used for expediting the process of creating sub-groups, if the sub-group to be added has the same configuration settings as one that already exists.

Copy an IP Sub-Group

To copy configurations made for a specified sub-group:

1. Choose Copy Sub Group from the sub-group menu.
2. Select the group from the tree and choose Paste Sub Group from the group menu to paste the sub-group to the group. (See Paste Sub Group dialog box in the Group section of this chapter.)

Individual IP

Individual IP includes options for creating and maintaining the filtering profile for the Individual IP member. Click the individual IP member’s link to view a menu of sub-topics: Members, Individual IP Profile, Exception URL, Time Profile, Approved Content (incl. VuSafe), Delete Individual IP.

Member window

The member window displays when Members is selected from the menu. This window is used for modifying the individual IP member’s IP address, if using the invisible or router mode. If using the mobile mode, the member’s MAC address can be selected for inclusion in the sub-group.



NOTE: See Appendix D: Mobile Client for information on modifying members when using the mobile mode.



Fig. 3:1-35 Member window

Enter the IP Address of the Member

In the Modify Individual Group Member frame:

1. Enter the IP address in the **Member** field.
2. Click **Modify** to apply your changes.

Individual IP Profile window

The Individual IP Profile window displays when Individual IP Profile is selected from the individual IP member menu. This window is used for viewing/creating the member's filtering profile. Click the following tabs in this window: Category, Redirect URL, and Filter Options. Entries in these tabs comprise the profile string for the member.



NOTE: See the Group Profile window in this chapter for information about entries that can be made for the following components of the filtering profile: Category Profile, Redirect URL, Filter Options.

Exception URL window

The Exception URL window displays when Exception URL is selected from the individual IP member menu. This window is used for blocking the member's access to specified URLs and/or for letting the member access specified URLs blocked at the minimum filtering level.



NOTE: See the Exception URL window in the Master IP Group sub-section of this chapter for information on entries that can be made in this window.

Time Profile window

The Time Profile window displays when Time Profile is selected from the individual IP member menu. This window is used for setting up or modifying a filtering profile to be activated at a specified time.



NOTE: See the *Time Profile window in the Master IP Group sub-section of this chapter for information on entries that can be made for the following components of the filtering profile: Category Profile, Redirect URL, Filter Options, Exception URL, Approved Content.*

Approved Content Settings window

The Approved Content Settings window displays when Approved Content (incl. VuSafe) is selected from the individual IP member menu. This window is used for granting access to a specified set of approved online videos posted to YouTube or SchoolTube—via a portal managed by someone within the organization—or videos posted to VuSafe.



NOTES: See the *Approved Content Settings window in Chapter 2 of the Global Administrator Section of this user guide for information about the Approved Content feature and VuSafe.*

See the *M86 Approved Content Portal Setup document at <http://www.m86security.com/software/8e6/docs/ug/misc/wf.ac.4.1.00.pdf> for information on setting up a portal and pass-keys for viewing online YouTube and/or SchoolTube videos. See the *Approved Content Settings window in the Master IP Group sub-section of this chapter for information on entries that can be made in this window.**

Delete Individual IP

Delete an Individual IP Member

To delete an individual IP member, choose Delete Individual IP from the individual IP member menu. This action removes the member from the tree.

Chapter 2: Library screen

Group administrators use windows and dialog boxes in the Library screen to look up URLs and to add and maintain custom library categories for a group. Library categories are used when creating or modifying filtering profiles.

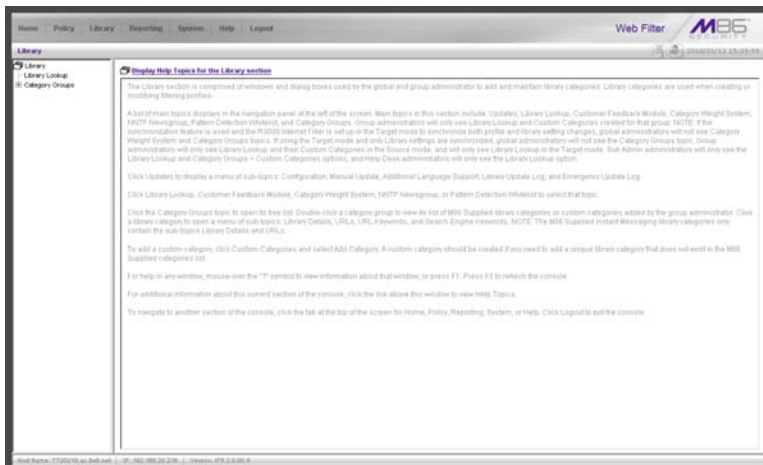

Fig. 3.2-1 Library screen

A list of main topics displays in the navigation panel at the left of the screen. Main topics in this section include the following: Library Lookup and Category Groups, the latter topic containing the Custom Categories sub-topic.



NOTE: If the synchronization feature is used, a server set up in the Target mode will only have the Library Lookup topic available.

Library Lookup

Library Lookup window

The Library Lookup window displays when Library Lookup is selected from the navigation panel. This window is used for verifying whether or not a URL or search engine keyword or keyword phrase exists in a library category.

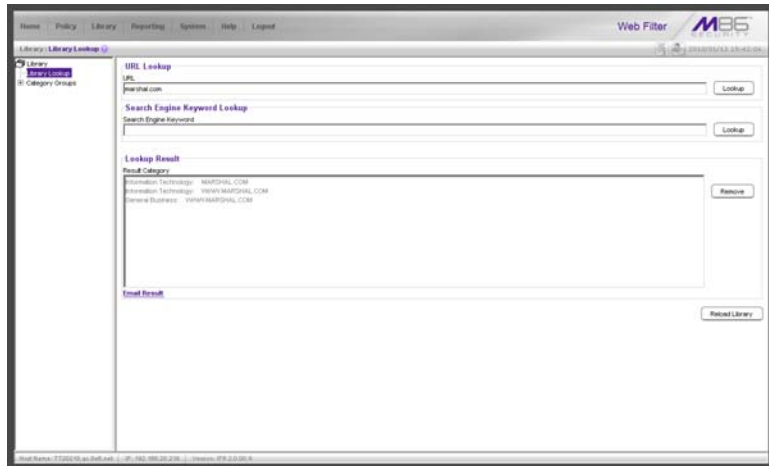

Fig. 3:2-2 Library Lookup window



NOTE: This window is also used by global administrators, except their permissions let them remove URLs and search engine keywords/phrases. The reload library function is used after making changes to the library.

Look up a URL

1. In the URL Lookup frame, enter the **URL**. For example, enter **http://www.coors.com**, **coors.com**, or use a wildcard by entering ***.coors.com**. A wildcard entry finds all URLs containing text that follows the period (.) after the asterisk (*).

The following types of URL formats also can be entered in this field:

- IP address - e.g. "209.247.228.221" in http://209.247.228.221
- octal format - e.g. http://0106.0125.0226.0322
- hexadecimal short format - e.g. http://0x465596d2
- hexadecimal long format - e.g. http://0x46.0x55.0x96.0xd2
- decimal value format - e.g. http://1180014290
- escaped hexadecimal format - e.g. http://%57%57%57.%41%44%44%49%43%54%49%4E%47%47%41%4D%45%53.%43%4F%4D
- query string - e.g. http://www.youtube.com/watch?v=3_Wfnj1IIMU



NOTES: The pound sign (#) character is not allowed in this entry. The minimum number of wildcard levels that can be entered is three (e.g. *.yahoo.com) and the maximum number of levels is six (e.g. *.mail.attachments.message.yahoo.com).

2. Click **Lookup** to open the alert box asking you to wait while the search is being performed.
3. Click **OK** to close the alert box and to display any results in the Result Category list box, showing the long name of the library category, followed by the URL.

Look up a Search Engine Keyword

To see if a search engine keyword or keyword phrase has been included in any library category:

1. In the Search Engine Keyword Lookup frame, enter the **Search Engine Keyword** or keyword phrase, up to 75 alphanumeric characters.
2. Click **Lookup** to display results in the Result Category list box, showing the long name of all categories that contain the search engine keyword/phrase.

Custom Categories

Custom Categories includes options for adding a custom category to the tree list and to refresh the menu. Click the Custom Categories link to view a menu of topics: Add Category, and Refresh.

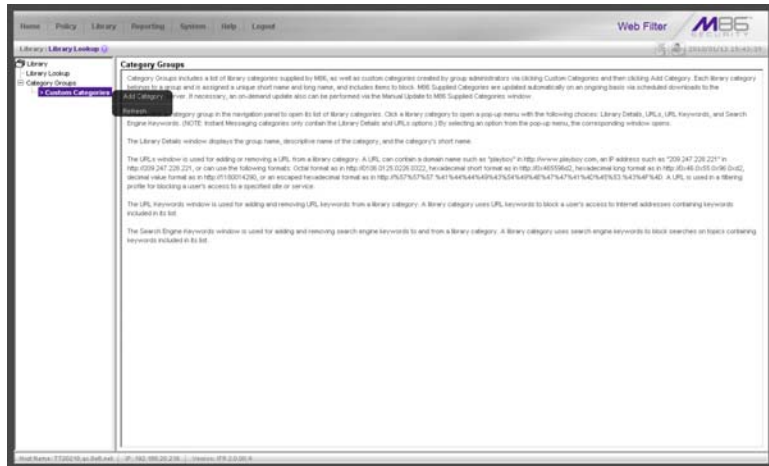

Fig. 3:2-3 Custom Categories menu



NOTE: Since custom categories are not created by M86, updates cannot be provided. Maintaining the list of URLs and keywords is the responsibility of the global or group administrator.



WARNING: *The maximum number of categories that can be saved is 512. This figure includes both M86 supplied categories and custom categories.*

Add Category

A unique custom library category should be created only if it does not exist in the Category Groups tree, and if any subgroup needs to use that library category. Custom library categories for a group must be maintained by the group administrator.

Add a Custom Library Category

1. Select Add Category to open the Create Category dialog box:

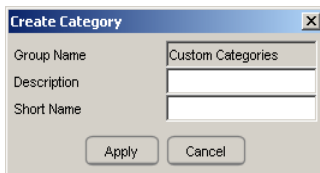

Fig. 3:2-4 Create Category dialog box

The **Group Name** field displays Custom Categories greyed-out.

2. In the **Description** field, enter from three to 20 characters for the long name of the new category.
3. In the **Short Name** field, enter up to seven characters without any spaces for the short name of the new category.



NOTE: *Once the short name has been saved it cannot be edited.*

4. Click **Apply** to add the category to the Custom Categories tree list. Upon saving this entry, the long name displays in the tree list. For group administrators adding a

new custom category, the group name displays in parentheses after the long name.



TIP: *If this is the first custom category you are adding, you may need to double-click “Custom Categories” to open the tree list.*



NOTE: *The category must have URLs, URL keywords, and/or search keywords added to its profile in order for it to be effective.*

Refresh

Refresh the Library

Click Refresh after uploading a file to a customized library category.

Custom library category

When a custom library category is created, its long name displays in the Custom Categories tree list. Click the custom library category link to view a menu of sub-topics: Library Details, URLs, URL Keywords, Search Engine Keywords, and Delete Category.

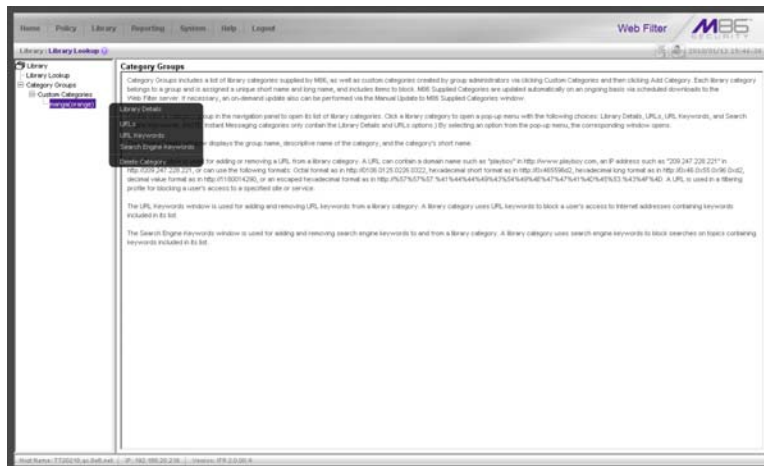

Fig. 3:2-5 Library screen, custom library category menu



NOTE: Since custom categories are not created by M86, updates cannot be provided. Maintaining the list of URLs and keywords is the responsibility of the global or group administrator.

Library Details window

The Library Details window displays when Library Details is selected from the library category's menu of sub-topics. This window is used for editing the long name of the custom library category, and for viewing name criteria previously entered.

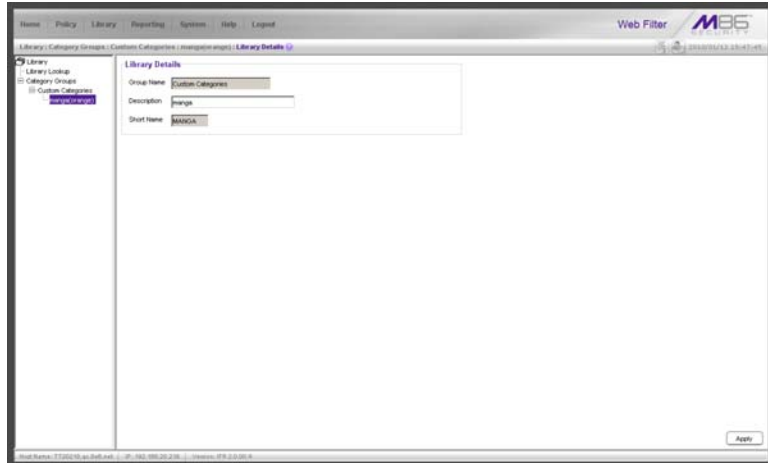

Fig. 3:2-6 Library Details window

View, Edit Library Details

The following display and cannot be edited: Custom Categories **Group Name** and library category **Short Name**.

1. The long **Description** name displays and can be edited.
2. After modifying the description for the library category, click **Apply** to save your entry.

URLs window

The URLs window displays when URLs is selected from the custom library category's menu of sub-topics. This window is used for viewing, adding and/or removing a URL from a custom library category's master URL list or master wildcard URL list. A URL is used in a filtering profile for blocking a user's access to a specified site or service.

A URL can contain a domain name—such as “playboy” in **http://www.playboy.com**—or an IP address—such as “209.247.228.221” in **http://209.247.228.221**. A wildcard asterisk (*) symbol followed by a period (.) can be entered in a format such as ***.playboy.com**, for example, to block access to all URLs ending in “.playboy.com”. A query string can be entered to block access to a specific URL.

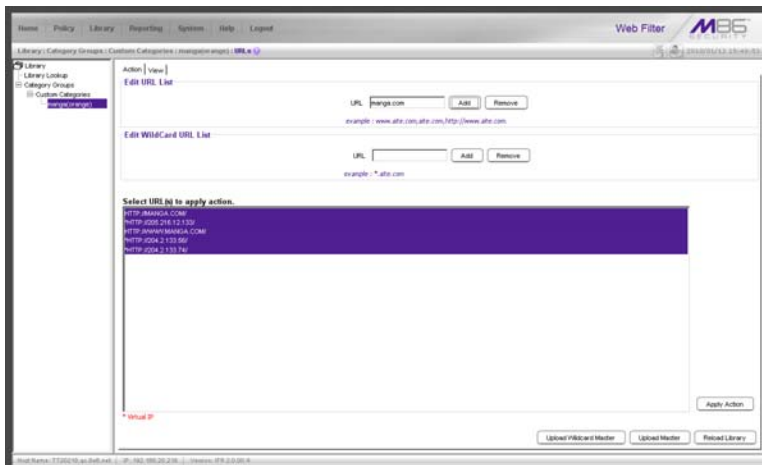

Fig. 3:2-7 URLs window, Action tab

View a List of URLs in the Library Category

To view a list of all URLs that either have been added or deleted from the master URL list or master wildcard URL list:

1. Click the View tab.
2. Make a selection from the pull-down menu for “Master List”, or “Wild Card Master List”.
3. Click **View List** to display the specified items in the Select List list box:

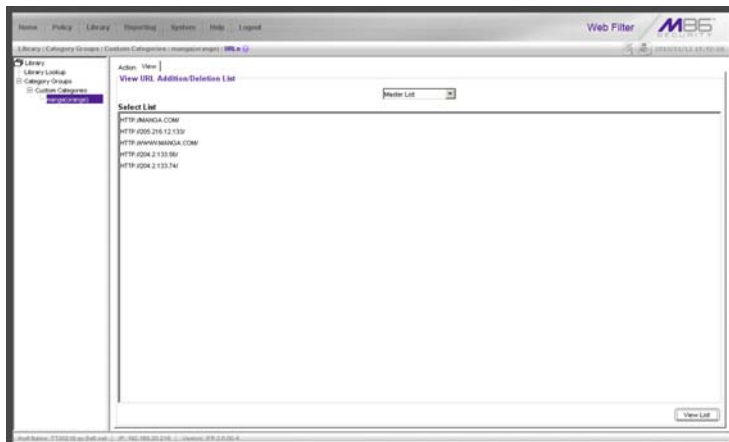

Fig. 3:2-8 URLs window, View tab

Add or Remove URLs or Wildcard URLs

The Action tab is used for making entries in the URLs window for adding or removing a URL or wildcard URL, uploading a master URL list or master wildcard URL list, or reloading the library.

Add a URL to the Library Category

To add a URL to the library category:

1. In the Edit URL List frame, enter the **URL** in a format such as **http://www.coors.com**, **www.coors.com**, or **coors.com**.

The following types of URL formats also can be entered in this field:

- IP address - e.g. "209.247.228.221" in http://209.247.228.221
- octal format - e.g. http://0106.0125.0226.0322
- hexadecimal short format - e.g. http://0x465596d2
- hexadecimal long format - e.g. http://0x46.0x55.0x96.0xd2
- decimal value format - e.g. http://1180014290
- escaped hexadecimal format - e.g. http://%57%57%57.%41%44%44%49%43%54%49%4E%47%47%41%4D%45%53.%43%4F%4D
- query string - e.g. http://www.youtube.com/watch?v=3_Wfnj1IIMU



NOTE: *The pound sign (#) character is not allowed in this entry.*

2. Click **Add** to display the associated URL(s) in the list box below.
3. Select the URL(s) that you wish to add to the category.

 **TIP:** Multiple URLs can be selected by clicking each URL while pressing the Ctrl key on your keyboard. Blocks of URLs can be selected by clicking the first URL, and then pressing the Shift key on your keyboard while clicking the last URL.

4. Click **Apply Action**.

Add a Wildcard URL to the Library Category

 **NOTE:** Wildcards are to be used for blocking only. They are not designed to be used for the always allowed white listing function.

To add a URL containing a wildcard to the library category:

1. In the Edit WildCard URL List frame, enter the asterisk (*) wildcard symbol, a period (.), and the **URL**.

 **TIP:** The minimum number of levels that can be entered is three (e.g. *.yahoo.com) and the maximum number of levels is six (e.g. *.mail.attachments.message.yahoo.com).

2. Click **Add** to display the associated wildcard URL(s) in the list box below.

3. Select the wildcard URL(s) that you wish to add to the category.

4. Click **Apply Action**.

 **NOTE:** Wildcard URL query results include all URLs containing text following the period (.) after the wildcard (*) symbol. For example, an entry of *.beer.com would find a URL such as http://virtualbartender.beer.com. However, if a specific URL was added to a library category that is **not** set up to be blocked, and a separate wildcard entry containing a portion of that URL is added to a category that **is** set up to be blocked, the end user will be able to access the non-blocked URL but not any URLs containing text following the wildcard. For example, if http://www.cnn.com is added to a category that is not set up to be blocked, and *.cnn.com is added to a category set up to be blocked, the end user will be able to access http://www.cnn.com since it is a direct match, but will not be able to access http://www.sports.cnn.com, since direct URL entries take precedence over wildcard entries.

Remove a URL from the Library Category

To remove a URL or wildcard URL from the library category:

1. Click the Action tab.
2. Enter the **URL** in the Edit URL List frame or Edit Wild-Card URL List frame, as pertinent.
3. Click **Remove** to display the associated URLs in the list box below.
4. Select the URL(s) that you wish to remove from the category.
5. Click **Apply Action**.

Upload a Master List to the Library

Upload a Master List of URLs

To upload a master file with URL additions:

1. Click **Upload Master** to open the Upload Custom Library URL pop-up window:

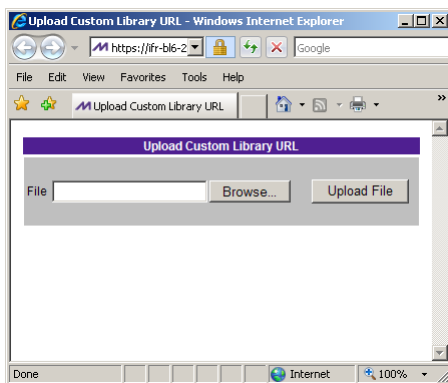





Fig. 3:2-9 Upload Custom Library URL window

2. Click **Browse...** to open the Choose file pop-up window.
3. Select the file to be uploaded.

 **TIP:** A URL text file must contain one URL per line.

 **WARNING:** The text file uploaded to the server will overwrite the current file.

 **NOTE:** Before the file is uploaded to the server, it will first be validated.

4. Click **Upload File** to display the results of the library file content validation in the Library File Content/IP Lookup Options pop-up window:

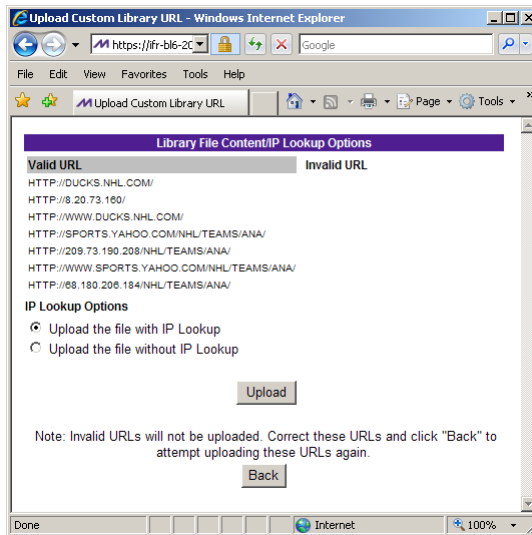

Fig. 3:2-10 Library File Content/IP Lookup Options

URLs contained in the file are listed under the column for either Valid URL or Invalid URL.

5. If the file contains invalid URLs, click **Back** to return to the Upload URL window. Another attempt to validate the file can be made after corrections have been made to the file.

If the file contains valid URLs:

- a. Go to the **IP Lookup Options** section and click the radio button corresponding to the option to be used when uploading the file:
 - “Upload the file with IP Lookup” - If this option is selected, IP addresses that correspond to URLs in the uploaded file will be blocked along with the URLs.
 - “Upload the file without IP Lookup” - If this option is selected, an IP lookup for IP addresses that correspond to URLs in the uploaded file will not be performed.
- b. Click **Upload** to open the Upload Successful pop-up window.



NOTE: In order for the URLs to take effect, library categories must be reloaded.

Upload a Master List of Wildcard URLs

To upload a master file with wildcard URL additions:

1. Click **Upload Wildcard Master** to open the Upload Custom Library WildCard URL pop-up window:

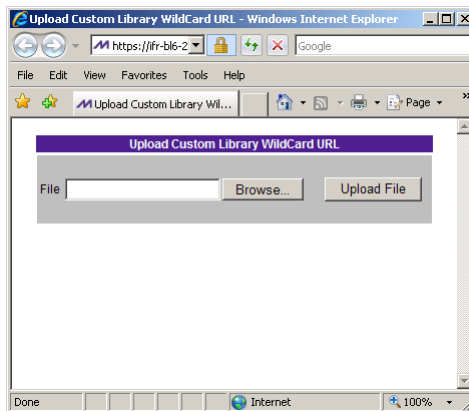





Fig. 3:2-11 Upload Custom Library WildCard URL window

2. Click **Browse...** to open the Choose file pop-up window.

3. Select the file to be uploaded.

 **TIP:** A wildcard URL text file must contain one wildcard URL per line.

 **WARNING:** The text file uploaded to the server will overwrite the current file.

 **NOTE:** Before the file is uploaded to the server, it will first be validated.

4. Click **Upload File** to display the results of the library file content validation in the Library File Content/IP Lookup Options pop-up window:

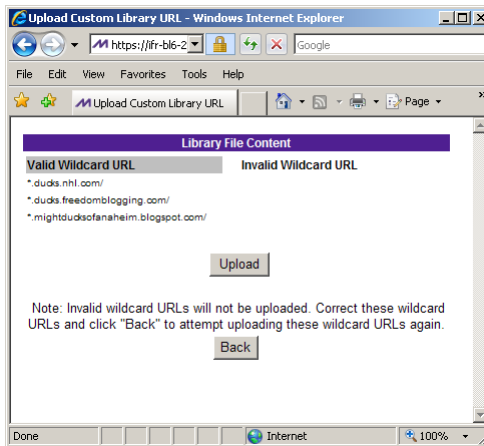

Fig. 3:2-12 Library File Content/IP Lookup Options

Wildcard URLs contained in the file are listed under the column for either Valid URL or Invalid URL.

5. If the file contains invalid wildcard URLs, click **Back** to return to the Upload WildCard URL window. Another attempt to validate the file can be made after corrections have been made to the file.

If the file contains valid wildcard URLs, click **Upload** to open the Upload Successful pop-up window.



NOTE: In order for the URLs to take effect, library categories must be reloaded.

Reload the Library

After all changes have been made to library windows, click **Reload Library** to refresh.



NOTE: Since reloading the library utilizes system resources that impact the performance of the Web Filter, M86 recommends clicking **Reload Library** only after modifications to all library windows have been made.

URL Keywords window

The URL Keywords window displays when URL Keywords is selected from the custom library category's menu of sub-topics. This window is used for adding or removing a URL keyword from a custom library category's master list. A library category uses URL keywords to block a user's access to Internet addresses containing keywords included in its list.

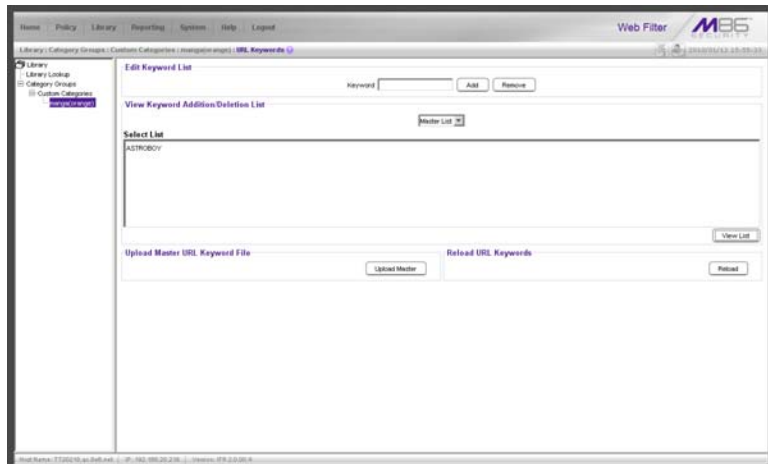

Fig. 3:2-13 URL Keywords window



NOTE: *If the feature for URL keyword filtering is not enabled in a filtering profile, URL keywords can be added in this window but URL keyword filtering will not be in effect for the user(s). (See the Filter Options tab in the Policy screen section for information about enabling URL keyword filtering.)*



WARNING: *Use extreme caution when setting up URL keywords for filtering. If a keyword contains the same consecutive characters as a keyword set up to be blocked, users will be denied access to URLs that are not even within blocked categories. For example, if all URL keywords containing “sex” are blocked, users will not be able to access a non-pornographic site such as <http://www.essex.com>.*

View a List of URL Keywords

To view a list of all URL keywords that either have been added or deleted:

1. In the View Keyword Addition/Deletion List frame, make a selection from the pull-down menu for “Master List”.
2. Click **View List** to display the specified items in the Select List list box.

Add or Remove URL Keywords

Add a URL Keyword to the Library Category

To add a URL keyword to the library category:

1. Enter the **Keyword** in the Edit Keyword List frame.
2. Click **Add**.

Remove a URL Keyword from the Library

To remove a URL keyword from the library category:

1. Enter the **Keyword**.
2. Click **Remove**.

Upload a List of URL Keywords to the Library

To upload a text file containing URL keyword additions:

1. In the Upload Master URL Keyword File frame, click **Upload Master** to open the Upload Library Keyword pop-up window:

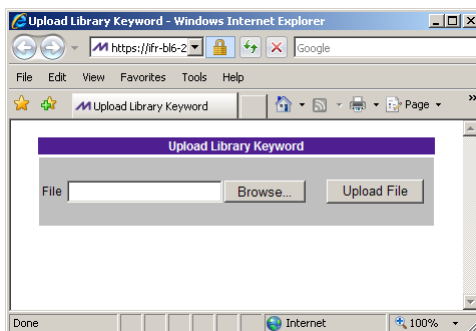



Fig. 3:2-14 Upload Library Keyword pop-up window

2. Click **Browse...** to open the Choose file window.
3. Select the file to be uploaded.
4. Click **Upload File** to upload this file to the server.

 **NOTE:** A URL keywords text file must contain one URL keyword per line.

 **WARNING:** The text file uploaded to the server will overwrite the current file.

Reload the Library

After all changes have been made to library windows, in the Reload URL Keywords frame, click **Reload** to refresh.

 **NOTE:** Since reloading the library utilizes system resources that impact the performance of the Web Filter, M86 recommends clicking Reload only **after** modifications to **all** library windows have been made.

Search Engine Keywords window

The Search Engine Keywords window displays when Search Engine Keywords is selected from the custom library category's menu of sub-topics. This window is used for adding and removing search engine keywords and phrases to and from a custom library category's master list. A library category uses search engine keywords to block searches on subjects containing keywords included in its list.

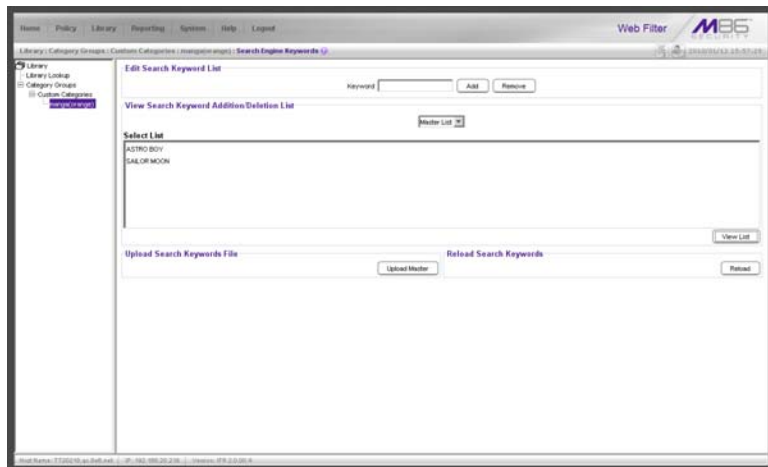

Fig. 3:2-15 Search Engine Keywords window



NOTE: If the feature for search engine keyword filtering is not enabled in a filtering profile, search engine keywords can be added in this window but search engine keyword filtering will not be in effect for the user(s). (See the Filter Options tab in the Policy screen section for information about enabling search engine keyword filtering.)



WARNING: Use extreme caution when setting up search engine keywords for filtering. If a non-offending keyword contains the same consecutive characters as a keyword set up to be blocked, users will be denied the ability to perform a search using keywords that are not even in blocked categories. For example, if all searches on “gin” are set up to be blocked, users will not be

able to run a search on a subject such as “cotton gin”. However, if the word “sex” is set up to be blocked, a search will be allowed on “sexes” but not “sex” since a search engine keyword must exactly match a word set up to be blocked.

View a List of Search Engine Keywords

To view a list of all search engine keywords that either have been added or deleted:

1. In the View Search Keyword Addition/Deletion List frame, make a selection from the pull-down menu for “Master List”.
2. Click **View List** to display the specified items in the Select List list box.

Add or Remove Search Engine Keywords

Add a Search Engine Keyword to the Library

To add a search engine keyword or keyword phrase to the library category:

1. In the Edit Search Keyword List frame, enter up to 75 alphanumeric characters in the **Keyword** field.
2. Click **Add**.

Remove a Search Engine Keyword

To remove a search engine keyword or keyword phrase from a library category:

1. In the Edit Search Keyword List frame, enter up to 75 alphanumeric characters in the **Keyword** field.
2. Click **Remove**.

Upload a Master List of Search Engine Keywords

To upload a master list containing search engine keyword/phrase additions:

1. In the Upload Search Keywords File frame, click **Upload Master** to open the Upload Library Keyword pop-up window (see Fig. 3:2-14).
2. Click **Browse...** to open the Choose file window.
3. Select the file to be uploaded.



TIP: A search engine keyword text file must contain one keyword/phrase per line.



WARNING: The text file uploaded to the server will overwrite the current file.

4. Click **Upload File** to upload this file to the server.

Reload the Library

After all changes have been made to library windows, in the Reload Search Keywords frame, click **Reload** to refresh.



NOTE: Since reloading the library utilizes system resources that impact the performance of the Web Filter, M86 recommends clicking **Reload** only **after** modifications to **all** library windows have been made.

Delete Category

Delete a Custom Category

To delete a custom library category, choose Delete Category from the menu. This action removes the library category from the Custom Categories list.

APPENDICES SECTION

Appendix A

Filtering Profile Format and Rules

A filtering profile must be set up in a specified format, containing the following items:

1. The username or group name
2. IP address or MAC address
3. Filtering profile criteria:
 - Rule number (Rule0, Rule1, etc.), or
 - rule criteria:
 - a. Ports to Block or Filter
 - b. Categories to Block or Open
 - c. Filter Mode
4. Redirect URL (optional)
5. Filter Options (optional). For IP profiles, the code 0x1 should be placed at the end with all filter options disabled.
6. Quotas (optional).



NOTE: *Each filtering profile should be entered on a separate line in the file.*

Rule Criteria

Rule criteria consists of selections made from the following lists of codes that are used in profile strings:

- **Port command codes:**

- A = Filter all ports
- B = Filter the defined port number(s)
- I = Open all ports
- J = Open the defined port number(s)
- M = Set the defined port number(s) to trigger a warn message
- Q = Block all ports
- R = Block the defined port number(s)

- **Port Numbers:**

- 21 = FTP (File Transfer Protocol)
- 80 = HTTP (Hyper Text Transfer Protocol)
- 119 = NNTP (Network News Transfer Protocol)
- 443 = HTTPS (Secured HTTP Transmission)
- Other

- **Filter Mode Values:**

- 1 = Default, Block Mode
- 2 = Monitoring Mode
- 4 = Bypassing Mode

- **Category command codes:**

Category command codes must be entered in the following order: J, R, M, I. "PASSED" should either be entered after J, R, or M, or after a string of category codes following J, R, or M.

J = Positioned before the category/categories defined as "always allowed."

R = Positioned before the category/categories defined as "blocked."

M = Positioned before the category/categories defined as containing URLs potentially against the organization's policies, and accompanied by a warning message.

I = Positioned at the end of a profile string, indicating that all other categories should "pass."

PASSED = When positioned at the end of a string of categories or after a category command code, this code indicates that unidentified categories will follow suit with categories defined by that code: J (pass), R (block), or M (receive warning message).

- **Category Codes:**

For the list of category codes (short names) and their corresponding descriptions (long names), go to **http://www.m86security.com/software/8e6/hlp/r3000/files/2group_textfile_cat.html#cat**



NOTE: *The list of library category codes and corresponding descriptions is subject to change due to the addition of new categories and modification of current categories. For explanations and examples of category items, go to **<http://www.m86security.com/resources/database-categories.asp>***

- **Filter Option codes:**

- 0x1 = Exception URL Query (always enabled)
- 0x2 = X Strikes Blocking
- 0x4 = Google/Bing/Yahoo!/Youtube/Ask/AOL Safe Search Enforcement
- 0x100 = Search Engine Keyword
- 0x200 = URL Keyword
- 0x1000= Extend URL Keyword Filter Control



NOTE: To enable multiple filter codes, add the codes together. For example, to enable all features for an IP profile, add $1 + 2 + 4 + 100 + 200 + 1000 = 1307$, which means that **0x1307** should be entered at the end of the profile string (unless the quota option is used, in which case the quota should be entered at the end of the profile string). To disable all filter codes for an IP profile, enter **0x1** for the filter option.

- **Quota format**

To include quotas in a profile string, enter them after the filter options using this format: A semicolon (;), Overall Quota minutes, a comma (,), the first library category code, a colon (:), the number of quota minutes, and a comma between each quota. For example: **;10,EMPL:30,FINAN:30,GENBUS:30,TRADING:30,ESTATE:30**



NOTES: See http://www.m86security.com/software/8e6/hlp/r3000/files/2group_ipprofiles.html for examples of filtering profile entries.

Appendix B

Create a Custom Block Page

M86 offers ways for you to customize the block page so that the page can have a different look while retaining the information/functionality provided in M86's default block page.



NOTE: The solutions provided in this appendix will only let you customize the Block page, not the Options page.

Part I: Modify the Web Filter

1. Enable block page redirection

Set up for each sub-group

1. Make modifications in one of the redirect URL tabs:
 - Go to: Policy > IP > "Group Name" > "Sub-Group Name" > Sub Group Profile > Redirect URL
 - Go to: Policy > Global Group > Global Group Profile > Default Redirect URL
2. Set the redirect URL to: `http://<server for block_page>[:<port for block page>]/<blockpage>`



NOTE: The Web Filter console does not accept the URL with a port setting (`:<port for block page>`), so to get around this the block page must be placed at the default HTTP port, which is 80. Since the console may not allow certain characters (e.g. "_"), if such characters are used in the URL a modified name must be used instead for the `<blockpage>`.

As a result, the Web Filter will redirect the block page to the customized one with the following link format:

http://<server for block_page>[:<port for block page>]/
<blockpage>?URL=<blocked url>&IP=<client
IP>&CAT=<URL category>&USER=<client User Name>

2. Exclude filtering <server for block page> IP

1. Go to: GUI: Policy > Global Group > Range to Detect
2. Input the IP address under “Destination IP” > ”Exclude IP”

Without excluding this IP address, the Web Filter may capture/filter/block the following redirect link:

http://<server for block_page>[:<port for block page>]/
<blockpage>?URL=<blocked url>&IP=<client
IP>&CAT=<URL category>&USER=<client User Name>

Part II: Customize the Block Page

1. Set up a Web server

A Web server must be set up to hold the customized block page.

2. Create a customized block page

The customized block page must be accessible via this link:

http://<server for block_page>[:<port for block page>]/
<blockpage>

Show M86's information in the block page (optional)

The following information is passed to the <blockpage> through the query string:

Name	Description: Value
URL	Blocked URL: <i>From the query string of the block page URL</i>
IP	IP that accessed the blocked URL: <i>(see URL)</i>
CAT	Category of the blocked URL: <i>(see URL)</i>
USER	User Name that accessed the blocked URL: <i>(see URL)</i>

Implement the "further option" (optional)

The "further option" is included in M86's default block page. If used, the <block page> needs to provide a link back to Web Filter's Options page and post the required hidden form data (shown in the table below):

Name	Description: Value
SITE	Optional value: <i>_BLOCK_SITE_</i>
URL	Blocked URL: <i>From the query string of the block page URL</i>
IP	IP that accessed the blocked URL: <i>(see URL)</i>
CAT	Category of the blocked URL: <i>(see URL)</i>
USER	User Name that accessed the blocked URL: <i>(see URL)</i>
STEP	Required value: <i>STEP 2</i>

Customized block page examples

The examples in the Reference portion of this appendix illustrate how form data is parsed and posted in the customized block page. Examples include:

1. HTML (using Java Script to parse/post form data)
2. CGI written in Perl
3. CGI written in C

See the Reference portion of this appendix for coding details.



NOTE: *Don't forget to replace <Web Filter IP> with the real IP in the HTML/CGI before using these samples.*

Part III: Restart the Web Filter

You must restart the Web Filter to make your changes effective.

Reference

HTML

```

<!-- Description: Sample HTML for Web Filter customized block page
-->
<!-- Replace <Web Filter IP> with real IP before using -->
<!-- Revision: 1 -->
<!-- Date: 03/08/2004 -->

<html>
<head>
<script language=javascript>
function parseData(str, start, end)
{
    result = "";
    i = str.indexOf(start);
    if (i >= 0) {
        len = str.length;
        substr = str.substr(i+start.length, len -
start.length);

        j = substr.indexOf(end);
        if ( j > 0) {
            result = substr.substring(0, j);
        }
        else {
            if ( j != 0) {
                len = substr.length;
                result = substr.substr(0, len);
            }
        }
    }
    return result;
}

function getData(){
    str = document.location.href;
    len = str.length;
    i = str.indexOf("?");
    if ( i>= 0) {
        query = str.substr(i+1, len-i-1);
        url = parseData(query, "URL=", "&");
        document.block.URL.value = url;
        ip = parseData(query, "IP=", "&");
        document.block.IP.value = ip;
        cat = parseData(query, "CAT=", "&");
        document.block.CAT.value = cat;
    }
}

```

```
        user = parseData(query, "USER=", "&");
        document.block.USER.value = user;
    }
}
function showData(){
    document.write("URL:" + document.block.URL.value + "<br>");
    document.write("IP:" + document.block.IP.value + "<br>");
    document.write("CAT:" + document.block.CAT.value + "<br>");
    document.write("USER:" + document.block.USER.value +
"<br>");
}
function do_options(){
    document.block.action="http://<Web Filter IP>:81/cgi/
block.cgi"
    document.block.submit();
}
</script>

</head>

<body>

<form method=post name=block >
    <input type=hidden name="SITE" value="_BLOCK_SITE_">
    <input type=hidden name="URL" value="">
    <input type=hidden name="IP" value="">
    <input type=hidden name="CAT" value="">
    <input type=hidden name="USER" value="">
    <input type=hidden name="STEP" value="STEP2">
</form>

<br>Web Filter Customized Block Page (HTML using Java Script to
parse and post form data)<br>
<script language=javascript>
    getData();
    showData();
</script>
<br>For further options, <a
href="javascript:do_options()">click here</a><br>

</body>
</html>
```

CGI written in Perl

There are two methods for CGI written in Perl: One lets you embed data in the query string to pass data to the Options CGI, and the other lets you use Java Script to post form data to the Options CGI.

Embed data in query string

```
#!/usr/bin/perl
# Original Filename: cusp_block1.cgi
# File Type:      CGI
# Description:    Sample Perl script for Web Filter customized block
page
# Replace the <Web Filter IP> with the real IP before using.
# This script provide data to the options CGI through query string
# Revision:      1
# Date: 03/08/2004

$method = $ENV{'REQUEST_METHOD'};

if ($method =~ /post/i) {
    $string = <STDIN>;
} else {
    $string= $ENV{"QUERY_STRING"};
}

$url = $1 if ($string =~ /URL=(\S+)&IP=/i);
$ip = $1 if ($string =~ /IP=(\S+)&CAT=/i);
$cat = $1 if ($string =~ /CAT=(\S+)&USER=/i);
$user = $1 if ($string =~ /USER=(\S+)/i);

print "Content-type: text/html\n\n";
print "<html>\n";
print "<head>\n";
print "</head>\n";
print "<body>\n";

print "<br>Web Filter Customized Block Page (CGI written with
Perl)<br>\n";

print "URL: $url<br>\n";
print "IP: $ip<br>\n";
print "CAT: $cat<br>\n";
print "USER: $user<br>\n";
```

```
print "<br>For further options, <a href=\"http://<Web Filter IP>:81/
cgi/
block.cgi?URL=$url&IP=$ip&CAT=$cat&USER=$user&STEP=STEP2\">click
here</a><br>\n";

print "</body>\n";
print "</html>\n";
```

Use Java Script to post form data

```
#!/usr/bin/perl
# Original Filename: cusp_block2.cgi
# File Type:          CGI
# Description:        Sample Perl script for Web Filter customized
block page
# Replace the <Web Filter IP> with the real IP before using.
# This script uses Java Script to post form data to
# options CGI
# Revision:           1
# Date: 03/08/2004

$method = $ENV{'REQUEST_METHOD'};

if ($method =~ /post/i) {
    $string = <STDIN>;
} else {
    $string= $ENV{"QUERY_STRING"};
}

$url = $1 if ($string =~ /URL=(\S*)&IP=/i);
$ip = $1 if ($string =~ /IP=(\S*)&CAT=/i);
$cat = $1 if ($string =~ /CAT=(\S*)&USER=/i);
$user = $1 if ($string =~ /USER=(\S*)/i);

print "Content-type: text/html\n\n";
print "<html>\n";

print "<head>\n";

print "<script language=\"JavaScript\">\n";
print "function do_options()\n";
print "{\n";
print "document.block.action=\"http://<Web Filter IP>:81/cgi/
block.cgi\"\n";
print "document.block.submit()\n";
print "}\n";
print "</script>\n";
print "</head>\n";
```

```
print "<body>\n";

print "<form method=post name=block>\n";
print "<input type=hidden name=\"SITE\"
value=\"_BLOCK_SITE_\">\n";
print "<input type=hidden name=\"IP\" value=\"$ip\">\n";
print "<input type=hidden name=\"URL\" value=\"$url\">\n";
print "<input type=hidden name=\"CAT\" value=\"$cat\">\n";
print "<input type=hidden name=\"USER\" value=\"$user\">\n";
print "<input type=hidden name=\"STEP\" value=\"STEP2\">\n";

print "<br>Web Filter Customized Block Page (CGI written with Perl
using Java Script to post form data)<br>\n";

print "URL: $url<br>\n";
print "IP: $ip<br>\n";
print "CAT: $cat<br>\n";
print "USER: $user<br>\n";

print "<br>For further options, <a
href=\"javascript:do_options()\">click here</a><br>\n";
print "</form>";

print "</body>\n";
print "</html>\n";
```

CGI written in C

```
/*
 * cusc_block.c
 * Description: sample C source code of CGI for customized block page
 * Replace <Web Filter IP> with real IP and recompile before using
 * Revision: 1
 * Date: 03/08/2004
 */
#include <stdio.h>

struct {
    char *name;
    char *val;
} entries[20];

char szIP[16];
char szURL[1024];
char szUserName[1024];
char szCategory[8];

/*function prototypes*/
void printhtml();
void unescape_url(char *url);
char x2c(char *what);
char *makeword(char *line, char stop);
void plustospace(char *str);
char *fmakeword(FILE *f, char stop, int *cl);
int to_upper(char *string);
void getquery(char *paramd, char **paramv);
void getnextquery(char **paramv);

int main(int argc, char **argv)
{
    int data_size; /* size (in bytes) of POST input */
    int index;
    char *paramd, *paramn, *paramv;
    char step[120];

    printf("content-type: text/html\n\n");

    /* If using the GET method */
    if (strcmp((char *)getenv("REQUEST_METHOD"), "GET") == 0)
    {
        paramd = (char *)strdup((char *)getenv("QUERY_STRING"));
        getquery(paramd, &paramv);
        while (paramv)
        {
            plustospace(paramv);
        }
    }
}
```

```

        unescape_url(paramv);
        paramn = (char *)makeword(paramv, '=');
        to_upper(paramn);

        if (strcmp(paramn, "IP") == 0)
            strcpy(szIP, paramv);
        else if (strcmp(paramn, "URL") == 0)
            strcpy(szURL, paramv);
        else if (strcmp(paramn, "CAT") == 0)
            strcpy(szCategory, paramv);
        else if (strcmp(paramn, "USER") == 0)
            strcpy(szUserName, paramv);

        getnextquery(&paramv);
    }
    free(paramd);
}
else
{
    /*=====
    Read stdin and convert form data into an array; set
    a variety of global variables to be used by other
    areas of the program
    =====*/
    data_size = atoi(getenv("CONTENT_LENGTH"));
    for(index = 0; data_size && (!feof(stdin)); index++)
    {
        entries[index].val = (char *)fmakeword(stdin, '&',
&data_size);
        plustospace(entries[index].val);
        unescape_url(entries[index].val);
        entries[index].name = (char
*)makeword(entries[index].val, '=');

        if (strcmp(entries[index].name, "IP") == 0)
            strcpy(szIP, entries[index].val);
        else if (strcmp(entries[index].name, "URL") == 0)
            strcpy(szURL, entries[index].val);
        else if (strcmp(entries[index].name, "CAT") == 0)
            strcpy(szCategory, entries[index].val);
        else if (strcmp(entries[index].name, "USER") == 0)
            strcpy(szUserName, entries[index].val);
    }
}

    printhtml();
}

void printhtml()

```

```

{
    printf("<html>\n");
    printf("<head>\n");
    printf("<script language=\"JavaScript\">\n");
    printf("function do_options()\n");
    printf("{\n");
    printf("document.block.action=\"http://<Web Filter IP>:81/cgi/
block.cgi\"\n");
    printf("document.block.submit()\n");
    printf("}\n");
    printf("</script>\n");
    printf("</head>\n");

    printf("<form method=post name=block >\n");
    printf("<input type=hidden name=\"SITE\"
value=\"_BLOCK_SITE_\">\n");
    printf("<input type=hidden name=\"IP\" value=\"%s\">\n", szIP);
    printf("<input type=hidden name=\"URL\" value=\"%s\">\n",
szURL);
    printf("<input type=hidden name=\"CAT\" value=\"%s\">\n",
szCategory);
    printf("<input type=hidden name=\"USER\" value=\"%s\">\n",
szUserName);
    printf("<input type=hidden name=\"STEP\"
value=\"STEP2\">\n");
    printf("<br>Web Filter Customized Block Page (CGI written with C
using Java Script to post form data)<br>\n");

    printf("URL: %s<br>\n", szURL);
    printf("IP: %s<br>\n", szIP);
    printf("CAT: %s<br>\n", szCategory);
    printf("USER: %s<br>\n", szUserName);

    printf("<br>For further options, <a
href=\"javascript:do_options()\">click here</a><br>\n");

    printf("</form>\n");
    printf("</body>\n");
    printf("</html>\n");
}

/* functions to get the CGI parameters */
void unescape_url(char *url)
{
    register int x,y;

    for(x=0,y=0;url[y];++x,++y)
    {
        if((url[x] = url[y]) == '%')

```



```

        {
            url[x] = x2c(&url[y+1]);
            y+=2;
        }
    }
    url[x] = '\0';
}

char x2c(char *what)
{
    register char digit;

    digit = (what[0] >= 'A' ? ((what[0] & 0xdf) - 'A')+10 :
(what[0] - '0'));
    digit *= 16;
    digit += (what[1] >= 'A' ? ((what[1] & 0xdf) - 'A')+10 :
(what[1] - '0'));
    return(digit);
}

char *makeword(char *line, char stop)
{
    int x = 0, y;
    char *word = (char *) malloc(sizeof(char) * (strlen(line) +
1));

    for(x=0;((line[x]) && (line[x] != stop));x++)
        word[x] = line[x];

    word[x] = '\0';
    if(line[x]) ++x;
    y=0;

    while(line[y++] = line[x++]);
    return word;
}

void plustospace(char *str)
{
    register int x;

    for(x=0;str[x];x++)
        if(str[x] == '+')
            str[x] = ' ';
}

char *fmakeword(FILE *f, char stop, int *cl)
{
    int wsize;

```

```
char *word;
int ll;

wsize = 102400;
ll=0;
word = (char *) malloc(sizeof(char) * (wsize + 1));

while(1)
{
    word[ll] = (char)fgetc(f);
    if(ll==wsize)
    {
        word[ll+1] = '\\0';
        wsize+=102400;
        word = (char
*)realloc(word,sizeof(char)*(wsize+1));
    }
    --(*c1);
    if((word[ll] == stop) || (feof(f)) || (!(*c1)))
    {
        if(word[ll] != stop)
            ll++;
        word[ll] = '\\0';
        return word;
    }
    ++ll;
}
}
/* to_upper:
 * Change the string to upper case
 */
int to_upper(char *string)
{
    int len;
    int i;
    char *tmp=NULL;

    if (string && strlen(string))
    {
        if (!(tmp=(char*)strdup(string)))
            return 0;
        len=strlen(string);
        for (i=0; i<len; i++)
        {
            string[i]=toupper(tmp[i]);
        }
        free(tmp);
    }
    return 1;
}
```

```
    }

void getquery(char *paramd, char **paramv)
{
    if (paramd == NULL)
        *paramv = NULL;
    else
        *paramv = (char *)strtok(paramd, "&");
}

void getnextquery(char **paramv)
{
    *paramv = (char *)strtok(NULL, "&");
}
```

Appendix C

Override Pop-up Blockers

An override account user with pop-up blocking software installed on his/her workstation will need to temporarily disable pop-up blocking in order to authenticate him/herself via the Options page:

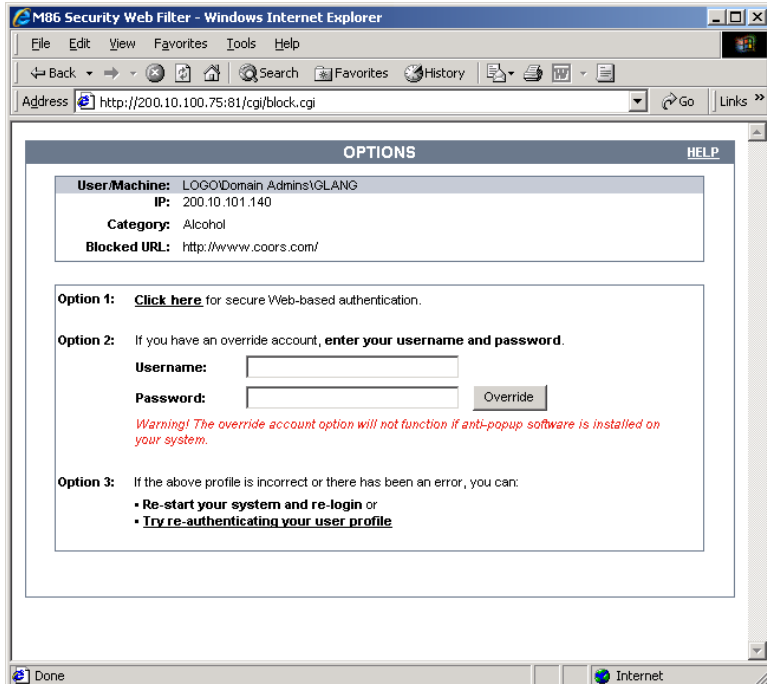

Fig. C-1 Options page

This appendix provides instructions on how to use an override account if typical pop-up blocking software is installed, as in the following products: Yahoo! Toolbar, Google Toolbar, AdwareSafe, Mozilla Firefox, and Windows XP Service Pack 2 (SP2).

Yahoo! Toolbar Pop-up Blocker

If Pop-up Blocking is Enabled

1. In the Options page (see Fig. C-1), enter your **Username** and **Password**.
2. Press and hold the **Ctrl** key on your keyboard while simultaneously clicking the **Override** button—this action opens the override account pop-up window.

Add Override Account to the White List

If the override account window was previously blocked by the Yahoo! Toolbar, it can be moved from the black list and added to the white list so that it will always be allowed to pass. To do this:

1. Go to the Yahoo! Toolbar and click the pop-up icon to open the pop-up menu:

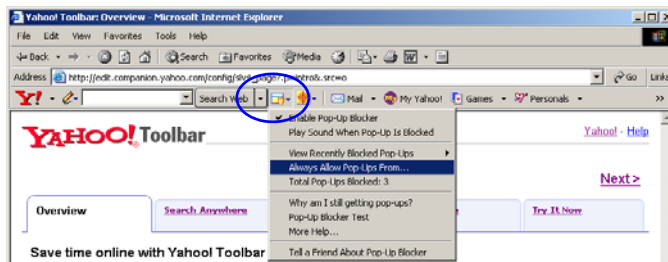

Fig. C-2 Select menu option Always Allow Pop-Ups From

2. Choose Always Allow Pop-Ups From to open the Yahoo! Pop-Up Blocker dialog box:

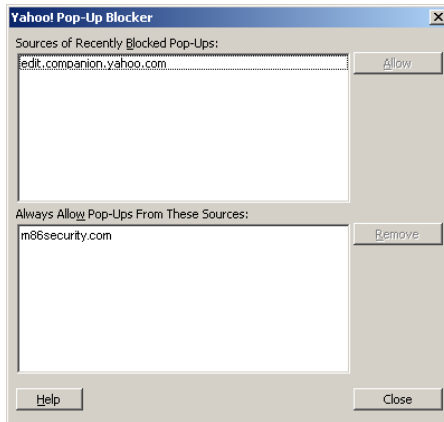

Fig. C-3 Allow pop-ups from source

3. Select the source from the Sources of Recently Blocked Pop-Ups list box to activate the Allow button.
4. Click **Allow** to move the selected source to the Always Allow Pop-Ups From These Sources list box.
5. Click **Close** to save your changes and to close the dialog box.

Google Toolbar Pop-up Blocker

If Pop-up Blocking is Enabled

1. In the Options page (see Fig. C-1), enter your **Username** and **Password**.
2. Press and hold the **Ctrl** key on your keyboard while simultaneously clicking the **Override** button—this action opens the override account pop-up window.

Add Override Account to the White List

To add the override account window to the white list so that it will always be allowed to pass, go to the Google Toolbar and click the Pop-up blocker button:

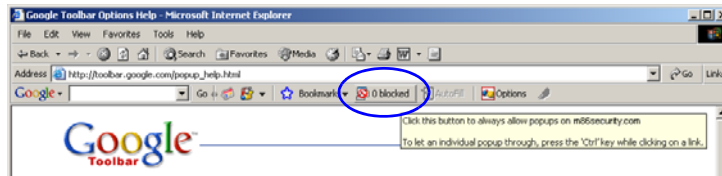

Fig. C-4 Pop-up blocker button enabled

Clicking this button toggles to the Pop-ups okay button, adding the override account window to your white list:

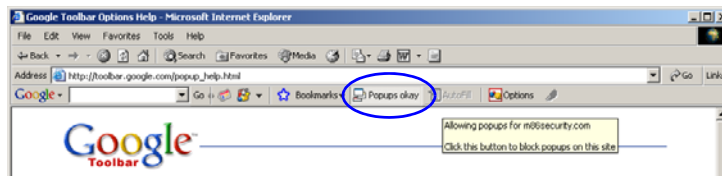

Fig. C-5 Pop-ups okay button enabled

AdwareSafe Pop-up Blocker

If Pop-up Blocking is Enabled

1. In the Options page (see Fig. C-1), enter your **Username** and **Password**.
2. Press and hold the **Ctrl** key on your keyboard while simultaneously clicking the **Override** button—this action opens the override account pop-up window.

Temporarily Disable Pop-up Blocking

AdwareSafe's SearchSafe toolbar lets you toggle between enabling pop-up blocking (# popups blocked) and disabling pop-up blocking (Popup protection off) by clicking the pop-up icon.

1. In the IE browser, go to the SearchSafe toolbar and click the icon for # popups blocked to toggle to Popup protection off. This action turns off pop-up blocking.
2. In the Options page (see Fig. C-1), enter your **Username** and **Password**.
3. Click the **Override** button to open the override account pop-up window.
4. Go back to the SearchSafe toolbar and click the icon for Popup protection off to toggle back to # popups blocked. This action turns on pop-up blocking again.

Mozilla Firefox Pop-up Blocker

Add Override Account to the White List

1. From the Firefox browser, go to the toolbar and select **Tools > Options** to open the Options dialog box.
2. Click the Content tab at the top of this box to open the Content section:

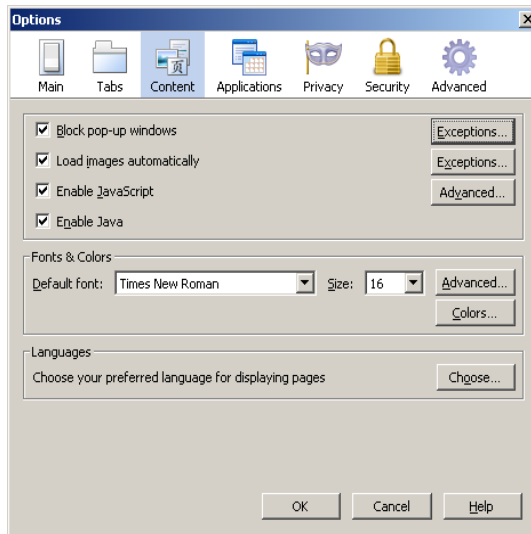

Fig. C-6 Mozilla Firefox Pop-up Windows Options

3. With the “Block pop-up windows” checkbox checked, click the **Exceptions...** button at right to open the Allowed Sites - Pop-ups box:

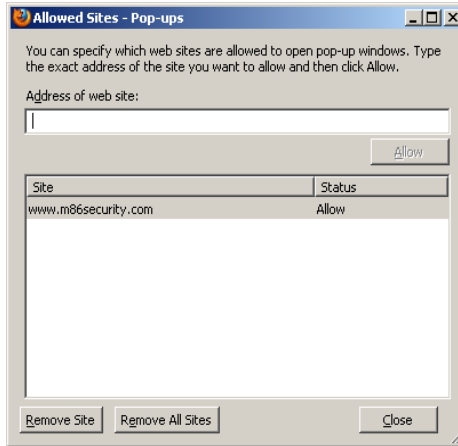

Fig. C-7 Mozilla Firefox Pop-up Window Exceptions

4. Enter the **Address of the web site** to let the override account window pass.
5. Click **Allow** to add the URL to the list box section below.
6. Click **Close** to close the Allowed Sites - Pop-ups box.
7. Click **OK** to close the Options dialog box.

Windows XP SP2 Pop-up Blocker

Set up Pop-up Blocking

There are two ways to enable the pop-up blocking feature in the IE browser.

Use the Internet Options dialog box

1. From the IE browser, go to the toolbar and select **Tools > Internet Options** to open the Internet Options dialog box.
2. Click the Privacy tab:

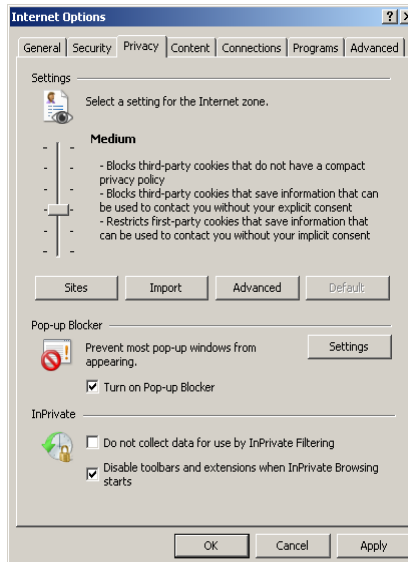

Fig. C-8 Enable pop-up blocking

3. In the Pop-up Blocker frame, check “Turn on Pop-up Blocker”.
4. Click **Apply** and then click **OK** to close the dialog box.

Use the IE Toolbar

In the IE browser, go to the toolbar and select **Tools > Pop-up Blocker > Turn On Pop-up Blocker**:

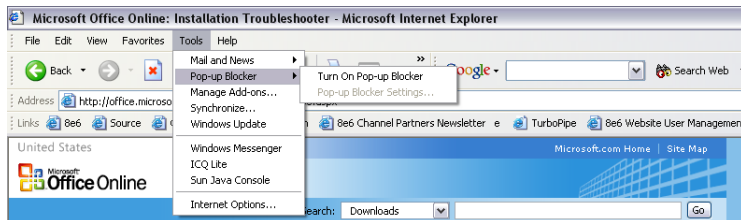

Fig. C-9 Toolbar setup

When you click Turn On Pop-up Blocker, this menu selection changes to Turn Off Pop-up Blocker and activates the Pop-up Blocker Settings menu item.

You can toggle between the On and Off settings to enable or disable pop-up blocking.

Temporarily Disable Pop-up Blocking

1. In the Options page (see Fig. C-1), enter your **Username** and **Password**.
2. Press and hold the **Ctrl** key on your keyboard while simultaneously clicking the **Override** button—this action opens the override account pop-up window.

Add Override Account to the White List

There are two ways to disable pop-up blocking for the override account and to add the override account to your white list.

Use the IE Toolbar

1. With pop-up blocking enabled, go to the toolbar and select **Tools > Pop-up Blocker > Pop-up Blocker Settings** to open the Pop-up Blocker Settings dialog box:

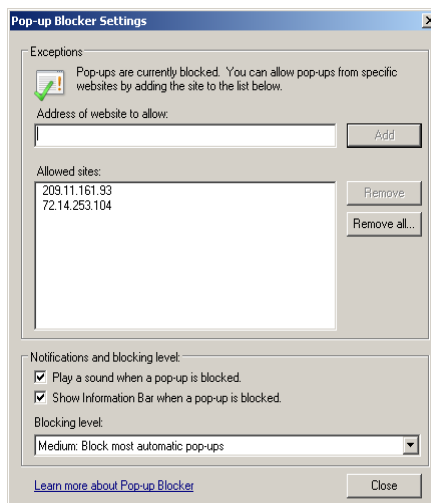

Fig. C-10 Pop-up Blocker Settings

2. Enter the **Address of Web site to allow**, and click **Add** to include this address in the Allowed sites list box. Click **Close** to close the dialog box. The override account window has now been added to your white list.
3. In the Options page (see Fig. C-1), enter your **Username** and **Password**.
4. Click the **Override** button to open the override account pop-up window.

Use the Information Bar

With pop-up blocking enabled, the Information Bar can be set up and used for viewing information about blocked pop-ups or allowing pop-ups from a specified site.

Set up the Information Bar

1. Go to the toolbar and select **Tools > Pop-up Blocker > Pop-up Blocker Settings** to open the Pop-up Blocker Settings dialog box (see Fig. C-10).
2. In the Notifications and Filter Level frame, click the checkbox for “Show Information Bar when a pop-up is blocked.”
3. Click **Close** to close the dialog box.

Access your Override Account

1. In the Options page (see Fig. C-1), enter your **Username** and **Password**.
2. Click the **Override** button. This action displays the following message in the Information Bar: “Pop-up blocked. To see this pop-up or additional options click here...”:

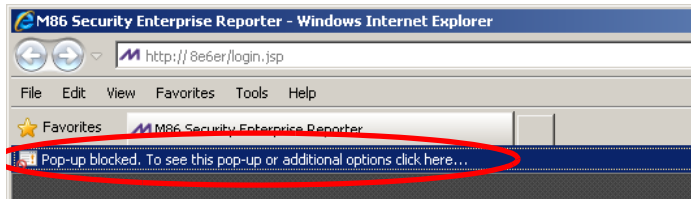

Fig. C-11 Information Bar showing blocked pop-up status

3. Click the Information Bar for settings options:

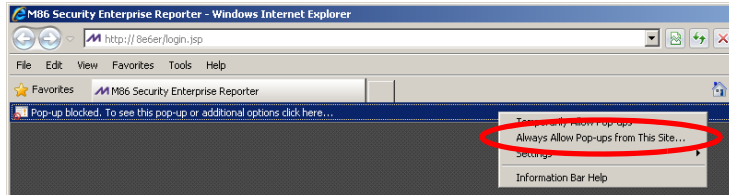

Fig. C-12 Information Bar menu options

4. Select Always Allow Pop-ups from This Site—this action opens the Allow pop-ups from this site? dialog box:

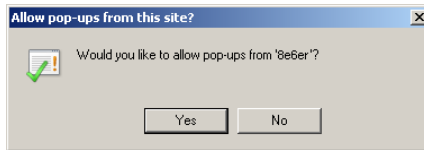



Fig. C-13 Allow pop-ups dialog box

5. Click **Yes** to add the override account to your white list and to close the dialog box.

 **NOTE:** To view your white list, go to the Pop-up Blocker Settings dialog box (see Fig. C-10) and see the entries in the Allowed sites list box.

6. Go back to the Options page and click **Override** to open the override account window.

Appendix D

Mobile Client

Mobile Client performs Internet filtering and blocking on mobile PCs physically located outside your organization. This product is comprised of a Web Filter configured to use the mobile mode, profiles of end users—working at home or on the road—uploaded to the Web Filter configured to use the mobile mode, and Mobile Client software installed on end users' workstations. Mobile Client ensures Internet activity of all end users located outside the organization will be tracked and filtered in the same manner as end users on the Web Filter used in house, thereby giving you, the administrator, assurance that your organization will be protected against lost productivity, network bandwidth issues, Internet security threats, and possible legal problems that can result from the misuse of Internet resources on an unfiltered, remote, laptop computer.

Environment Requirements

Workstation Requirements

System requirements for the administrator include the following:

- Web Filter must be configured to use the Mobile mode option
- Session cookies from the Web Filter must be allowed in order for the Administrator console to function properly
- Pop-up blocking software, if installed, must be disabled
- JavaScript enabled
- Java Virtual Machine
- Java Plug-in (use the version specified for the Web Filter software version)

System requirements for the end user include the following:

- Windows XP, Vista (32-bit), or 7 (32-bit) operating system running:
 - Internet Explorer (IE) 7.0 or 8.0
 - Firefox 3.5 or 3.6
- Macintosh OS X Version 10.5 or 10.6 running:
 - Safari 4.0
 - Firefox 3.5 or 3.6



WARNING: *The filtered end user must be set up with standard user rights only—these users should **not** have Power User, Administrator, or root level access.*

Network Requirement

- High speed connection from the Web Filter to mobile PCs

Remote Filtering Components

- Mobile Client software installed on each end user's mobile PC

Work Flow Overview

Mobile Client Installed on a Mobile PC

For mobile PCs located outside of the organization:

- a Web Filter set up for filtering in the mobile mode is used for obtaining the end user's profile and for logging his/her Internet activity
- the Mobile Client application is used on the remote PC for filtering the end user's Internet activity

When these two components are installed, the following scenario occurs on the network:

1. The end user logs into his/her mobile PC located outside of the organization, and then makes a URL request.
2. The Mobile Client detects the Web Filter, and the Web Filter grants the URL request or blocks the request, based on the end user's profile supplied by the Mobile Client.
3. If the end user comes into the organization, logs into his/her workstation and is authenticated on the internal network, the end user's profile now comes from the Web Filter, and not the Mobile Client.

Network Operations Overview

Mobile Client on the Network

Mobile Client

1. A URL request is made from an end user's mobile PC to access inappropriate content on the Internet.
2. The Mobile Client installed on the end user's workstation sends a parallel request to the Web Filter.
3. The Web Filter searches its M86 database for a match to the request. If a match to the requested URL is found and the site is disallowed, the Mobile Client software blocks the connection to the Web server.



NOTE: *If using Mobile Client software version 2.0 or higher in a Macintosh environment, and the Web Filter is configured to use the "High" HTTPS Filtering Level, Macintosh end users will be blocked from accessing any HTTPS URL. (See the Filter window in this User Guide for information about setting the HTTPS Filtering Level.)*

Enterprise Reporter

1. The Web Filter sends logs to the local Enterprise Reporter (ER) for processing.
2. Using the ER Web Client, an administrator can generate customized reports on the remote end user in minutes.

Mobile Server Section

The Mobile Server Section of this user guide contains information on how to set up and configure the Web Filter's hardware and software to be used with the Mobile Client.

Initial Setup

The basic requirements for initial network setup are as follows:

- Port 81 must be open on the network for block page requests
- Port 443 must be open on the network for the Mobile Client to communicate with the Web Filter.



NOTE: *The Web Filter can be set up on the WAN network's DMZ for extra security purposes.*

Configure the Web Filter to use the Mobile Mode

The Operation Mode window is used for setting up the Web Filter to use the mobile mode for filtering mobile PCs.

1. In the Mode frame, choose either “Mobile Only” or one of the filtering modes (Invisible, Router, Firewall) with the “Mobile” option added to display the Mobile Client Control frame, used for configuring the Web Filter to use the mobile mode:

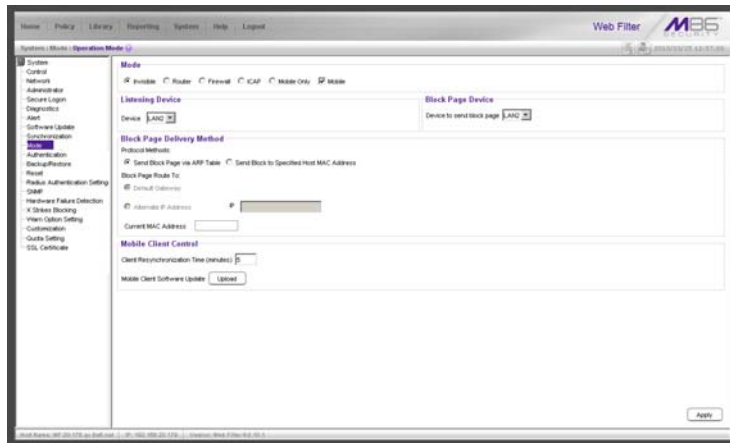

Fig. D-1 Operation Mode window, mobile mode

2. In the **Client Resynchronization Time** field, specify the interval of minutes for the Web Filter to resynchronize the profile on the end user's workstation with the profile set up for him/her on the Web Filter. By default, 60 minutes displays.



NOTES: The Mobile Client Software Update field is used if you wish to update end user workstations automatically with the latest configuration files and will be using the Web Filter to host and deploy these files. More information about using this feature is provided in subsequent pages in this section of the user guide.

The following features are not available when using the mobile mode: Minimum Filtering Level, Time Profile, Override Account,

Exception URL, LDAP Authentication, and Warn and Quota filter settings. (An end user with categories blocked in his/her profile will be blocked from categories with a Warn or Quota setting instead of receiving a warning or quota page. If his/her profile does not contain blocked categories but instead contains categories with Warn or Quota settings, the Global Group Profile will be assigned instead.)

3. Click **Apply** to apply your settings.

Add MAC Addresses to the Master IP Group

In the mobile mode, the master IP group Members window is used for adding mobile PC MAC addresses. MAC addresses are used for obtaining mobile PC members' filtering profiles.

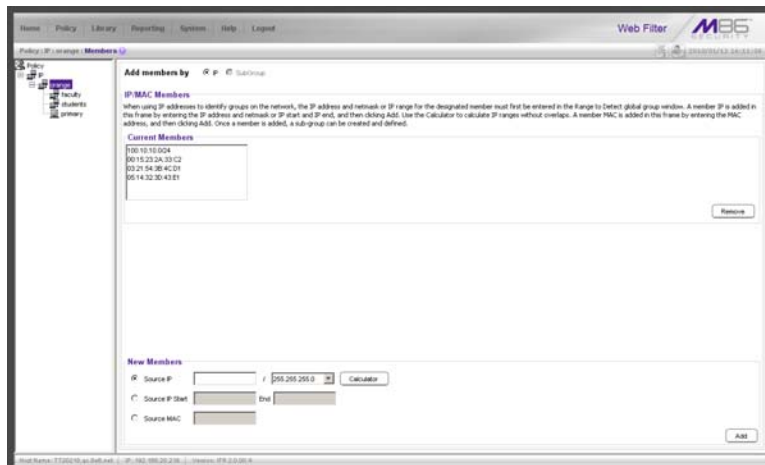

Fig. D-2 Members window, master IP group with MAC addresses

1. In the New Members frame, select “Source MAC”.
2. Enter the member’s MAC address.
3. Click **Add** to include the MAC address entry in the Current Members list box.



NOTES: Follow steps 2-3 for each MAC address to be added. To remove a member from the Current Members list box, select the MAC address from the list box, and then click **Remove**.

Select MAC Addresses for a Sub Group

In the mobile mode, the sub-group Members window is used for selecting MAC addresses for inclusion in the sub-group.

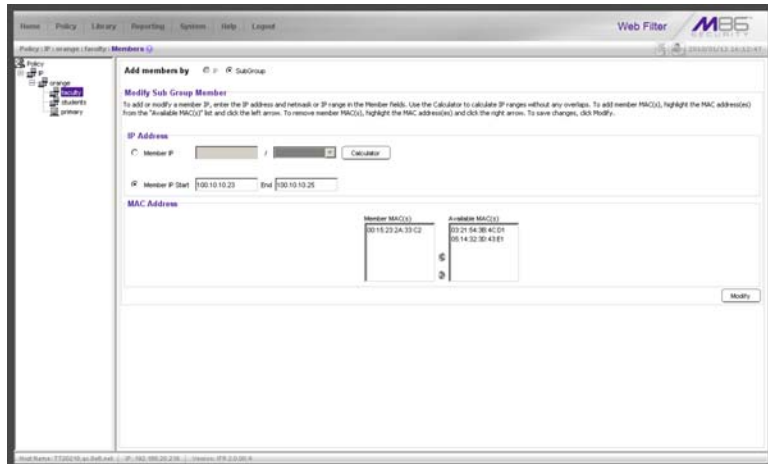

Fig. D-3 Members window, sub-group with MAC addresses

The Modify Sub Group Member frame is comprised of the IP Address and MAC Address frames.

1. In the MAC Address frame, Source MAC addresses previously added in the master IP group's Members window display in the Available MAC(s) and/or Member MAC(s) list box(es). Specify whether or not to add/remove MAC addresses to/from the sub-group:
 - To add MAC addresses to the sub-group, select each sub-group by highlighting it in the Available MAC(s) list box, and then clicking the left arrow to move the item(s) to the Member MAC(s) list box.

- To remove MAC addresses from the sub-group, select each sub-group by highlighting it in the Member MAC(s) list box, and then clicking the right arrow to move the item(s) to the Available MAC(s) list box.



TIPS: Multiple MAC addresses can be moved to a list box by clicking each MAC address while pressing the Ctrl key on your keyboard, and then clicking the arrow key pointing to that list box.

Blocks of MAC addresses can be moved to a list box by clicking the first MAC address, and then pressing the Shift key on your keyboard while clicking the last MAC address, and then clicking the arrow key pointing to that list box.

2. Click **Modify** to apply your settings.

View Sub Group MAC Addresses

When using the mobile mode, the Sub Group (IP Group) window is used for viewing this sub-group's MAC addresses previously added in the sub-group's Members window.

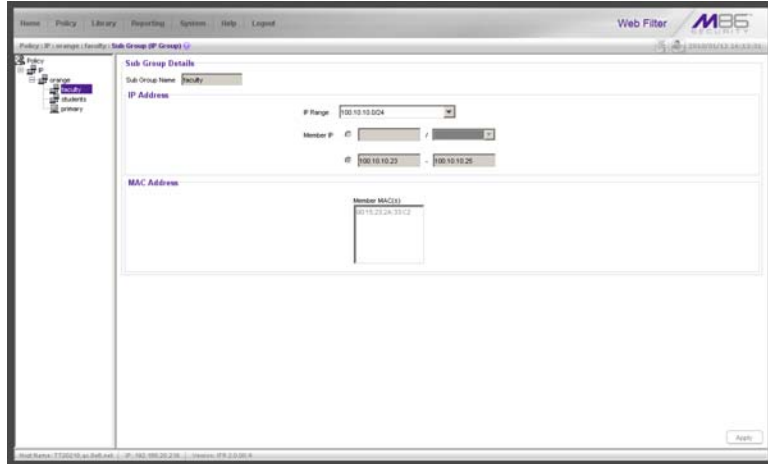

Fig. D-4 Sub Group (IP Group) window, view MAC Addresses

MAC addresses display in the Member MAC(s) list box in the MAC Address frame.

If the sub-group has been completely defined, IP address criteria was entered in the IP Address frame and saved in this window.

Add a MAC Address to an Individual Member

When using the mobile mode, the Individual IP's Member window is used for selecting the member's MAC address for inclusion in the sub-group.



Fig. D-5 Member window with MAC Address

1. In the Modify Individual Group Member frame, select the member's **MAC Address** from the pull-down menu.
2. Click **Modify** to apply your changes.

Upload MAC Address File for IP Group

A file containing multiple MAC addresses can be uploaded to the master IP group using the Upload/Download IP Profile window.

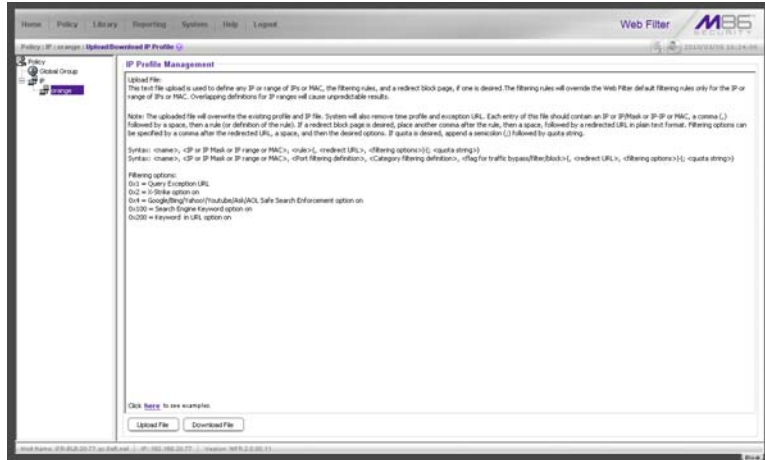

Fig. D-6 Master IP group's Upload/Download IP Profile window



WARNING: Any existing profiles will be overwritten by the contents of the uploaded file.

If the end user has both an IP address and a MAC address, each profile should be entered on a separate line in the file.

For example, if end user “tlind” has the IP address 150.100.30.2 and MAC address 00:04:21:AF:33:E1, the following entries for that user’s profile would be made on two separate lines in the master IP group’s profile file:

```
tlind, 150.100.30.2,A,J CHAT R GPORN M I,1, ,0x103
tlind, 00:04:21:AF:33:E1,A,J CHAT R GPORN M I,1, ,0x103
```



NOTE: For other examples of entries to include in the profile file, go to http://www.m86security.com/software/8e6/hlp/r3000/files/2group_ipprofiles.html.

Troubleshoot MAC Addresses

When using the mobile mode, the Active Profile Lookup is used for verifying whether an entity has an active filtering profile for his/her MAC address. This window also is used for troubleshooting synchronization on "target" Web Filters, to verify whether settings for user profiles match the ones synced over from the "source" Web Filter.



Fig. D-7 Active Profile Lookup window with MAC Address



NOTE: See Active Profile Lookup window in Chapter 1: System screen from the Global Administrator Section for information on using the Active Profile Lookup window.

Mobile Client Section

The Mobile Client Section of this user guide contains information on how the Windows network administrator uses the Mobile Client Deployment Kit to install the Mobile Client on a Windows or Macintosh network, configure the Mobile Client via the Package Editor, deploy the Mobile Client to Windows or Macintosh OS X end user workstations, and uninstall the Mobile Client.

The Mobile Client Deployment Kit is comprised of the following resources:

- Unconfigured packages containing the Mobile Client software (8e6client.msi for Windows, and 8e6clientInstaller.mpkg.tar for Macintosh OS X)



NOTE: *The unconfigured 8e6clientInstaller.mpkg.tar package in this kit contains Mobile Client software for Macintosh OS X and should be used in a “Macintosh only” environment.*

- A tool for setting or modifying Mobile Client packages (the “package editor,” Mc_tool.exe)
- The optional Mobile Client Updater (MCU) component that updates Mobile Client binaries from your Mobile Server running M86 Web Filter software version 4.0 or higher, or from your own Web server (the “updater,” 8e6winmcu.msi for Windows, and 8e6osxmcu.pkg.tar for Macintosh OS X)
- An .msi package that can be assigned via Group Policy to workstations to remove a previously-installed Mobile Client package (the “remover,” 8e6purge.msi)
- Online help instructions for configuring, deploying, and removing the Mobile Client.

Download and Install the Deployment Kit

To download the Mobile Client Deployment Kit to your machine:

1. Launch the M86 Mobile Client Web page, and then find and click the link for the Mobile Client Deployment Kit Installer (.msi file) you wish to download to your machine.



NOTES: Please contact technical support if you need the link to the M86 Mobile Client Web page.



WARNING: If a prior version of the Mobile Client is installed on your workstation (i.e. software version 1.x or 2.x), you must *uninstall* that software before installing software version 3.0. (See *Mobile Client Removal from Computers for information about using 8e6purge.msi to uninstall the Mobile Client.*)

2. Once the .msi file is downloaded to your machine, click that file to launch the Mobile Client Deployment Kit Setup Wizard:



Fig. D-8 Mobile Deployment Kit Setup Wizard

3. Click **Next** to read the End User License Agreement and to accept its terms by clicking the checkbox corresponding to “I accept the terms in the License Agreement”:

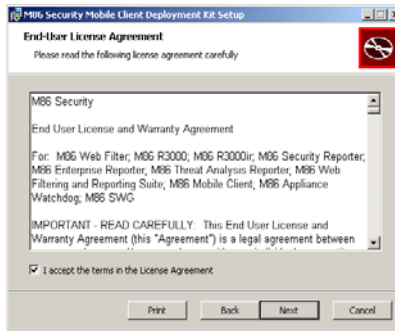

Fig. D-9 End User License Agreement

4. Click **Next** to go to the Choose Setup Type step, and select the setup option for installing the Mobile Client: "Typical", "Custom", "Complete":

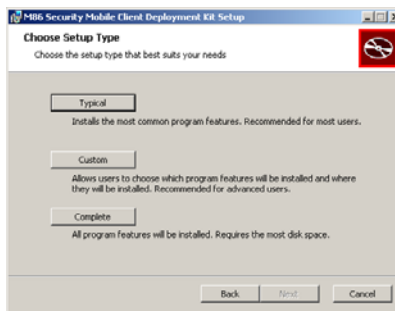

Fig. D-10 Choose Setup Type

5. Click **Next** to proceed with the option you selected for installing the application. If you chose the Custom option, you will need to specify where or how the main executable and support files will be installed on your machine, and/or where or how Windows and Macintosh packages for the Mobile Client will be installed for distribution to user workstations.

When your machine is ready to install the Deployment Kit, the page that confirms the installation process is ready to begin displays:

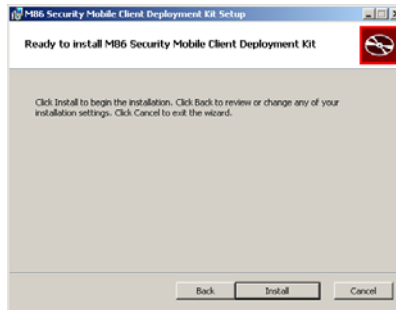

Fig. D-11 Installation process ready to begin

6. Click **Install** to begin the installation process. The following page displays when the installation process is complete:



Fig. D-12 Installation complete

7. Click **Finish** to close the wizard dialog box.

Access the Mobile Client Deployment Tool window

Once the Mobile Client Deployment Kit is installed on your machine, the Mobile Client Deployment Tool window (see Fig. D-13) and Package Configuration window (see Fig. D-15) are used for configuring packages for Windows or Macintosh.



NOTE: Refer to the instructions in this section of the user guide or consult the help topics via the **Help** link in the Mobile Client Deployment Tool for instructions on using these windows.

The Mobile Client Deployment Tool window is accessible via **Start > All Programs > M86 Security Mobile Client Deployment Kit > Package Editor:**

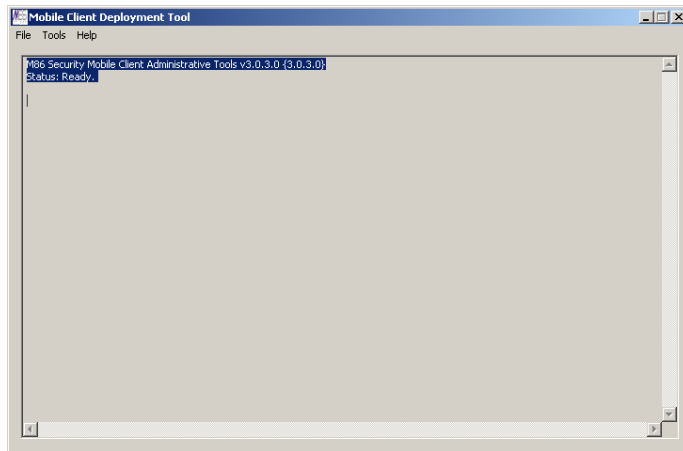

Fig. D-13 Mobile Client Deployment Tool window

The Mobile Client Deployment Tool's package editor log window displays the operations performed when creating and configuring packages.



NOTES: Before exiting the Mobile Client Deployment Tool and Package Configuration windows, be sure to save all entries you intend to save for packages you've configured. To exit the Mobile Client Deployment Tool window, with the Package Configuration window closed, go to **File > Exit**.

Configure a New Package Set

1. In the Mobile Client Deployment Tool window, go to **File > New Package...** to open the Choose Product Version dialog box:

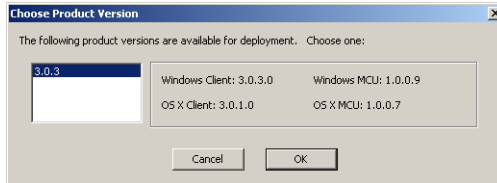

Fig. D-14 Choose Product Version dialog box

2. Select the Mobile Client software version from the available choices, and then click **OK** to close the Choose Product Version dialog box and to open the Package Configuration window:

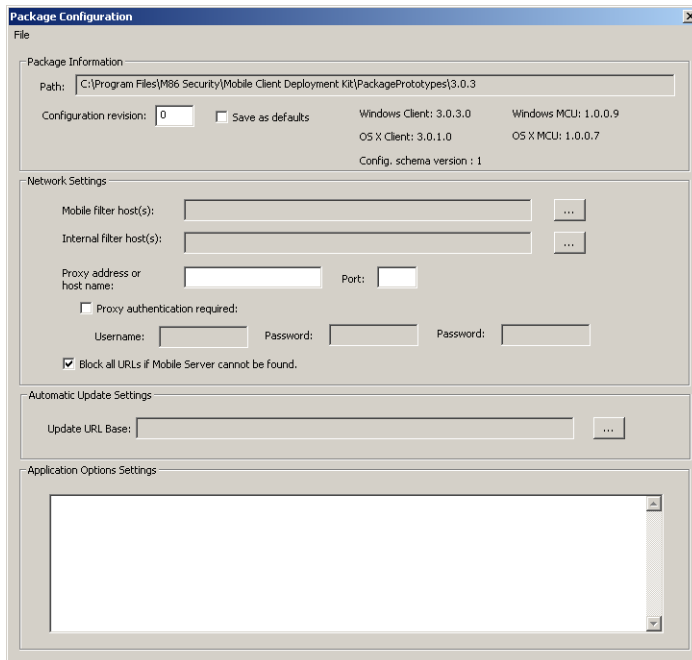

Fig. D-15 Package Configuration window

The Package Configuration window is comprised of the following frames: Package Information, Network Settings, Automatic Update Settings, and Application Options Settings.



NOTE: To exit the Package Configuration window at any time before saving your edits, select **File > Cancel** from the menu.

Specify Package criteria

The Package Information frame includes the following information: Path on the system where the current package is located, Configuration revision number, Configuration schema version number, and package version numbers.

The following fields are editable:

- **Configuration revision:** This number is automatically incremented by “1” each time changes made to the package configuration are saved. When deploying the Mobile Client to end user workstations, the installer uses this revision number to determine whether a newer configuration is already installed on the workstation.



TIP: To ensure updates to end user workstations are properly applied, if you are making configuration-only changes, it is better to edit the previous package rather than create a new one.

- **Save as defaults:** By checking this box, your configuration will be saved in a central defaults file for use in the next “Save” command.



TIP: By enabling this feature, if creating a new package you can apply these saved default settings to the new package by choosing **File > Apply Defaults** from the menu.



NOTE: To edit the default settings, from the Mobile Client Deployment Tool window select **Tools > Edit default configuration...** (see *Edit a Package Configuration: Edit default configuration settings for information about making edits to default settings*).

Configure Network Settings

The Network Settings frame includes fields for entering IP addresses of host servers used for filtering mobile workstations and in-house workstations, and proxy server criteria—the latter, if a proxy server is used with filtering servers on your network.

Add, remove mobile filter host server

1. Click the ellipses (...) button to the right of the **Mobile filter host(s)** field to open the Add/Remove Mobile Filter Host(s) dialog box:

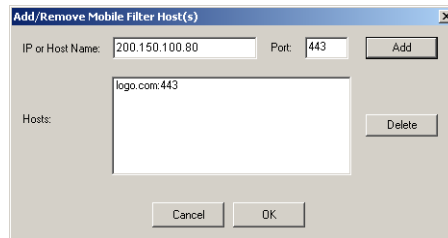

Fig. D-16 Add/Remove Mobile Filter Host(s)

2. In the **IP or Host Name** field, enter the public IP address or hostname of your mobile filter host server.
3. By default, **443** displays in the **Port** field and should not be modified unless the mobile filter host server is on another port.
4. Click **Add** to include the entry in the list box below.
5. After entering host criteria for each mobile filter, click **OK** to close the dialog box and to display your entries in the Mobile filter host(s) field of the Package Configuration window.



NOTE: To remove a mobile filter from the list, select the entry from the Hosts list box, click **Delete**, and then click **OK**.

Add, remove internal filter host server



NOTE: Entries made in this portion of the user interface are optional. If you have one filter host server on your network, the IP address would be the same IP address you entered for the mobile filter host server.

1. Click the ellipses (...) button to the right of the **Internal filter host(s)** field to open the Add/Remove Internal Filter Host(s) dialog box:

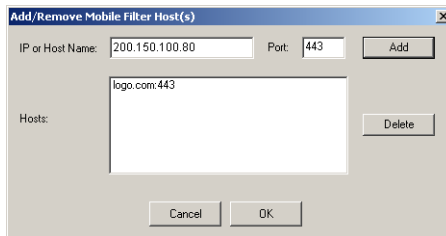

Fig. D-17 Add/Remove Internal Filter Host(s)

2. In the **IP or Host Name** field, enter the public IP address or hostname of your internal filter host server.
3. By default, 81 displays in the **Port** field and should not be modified unless the internal filter host server is using a different port.
4. Click **Add** to include the entry in the list box below.
5. After entering host criteria for each internal filter, click **OK** to close the dialog box and to display your entries in the Internal filter host(s) field of the Package Configuration window.



NOTE: To remove an internal filter from the list, select the entry from the Hosts list box, click **Delete**, and then click **OK**.

Add proxy address or host name

1. If your organization is using a proxy server on the network, in the **Proxy address or host name** field, enter the IP address or host name of your proxy server.
2. In the **Port** field, enter the port number for this proxy server.
3. If authentication is required for the Mobile Client to communicate with this proxy server, do the following:
 - a. Click the “Proxy authentication required” checkbox; this action activates the Username and Password fields.
 - b. Enter the proxy server **Username**.
 - c. Enter the proxy server **Password** twice.

Optional: Block all URLs if Mobile Server cannot be found

The “Block all URLs if Mobile Server cannot be found.” checkbox is checked by default. This setting indicates that if the Mobile Client cannot detect the mobile filter host server, all URLs requested by the end user will be blocked.

Uncheck this box if the end user’s workstation should be permitted unrestricted Internet access when the mobile filter host server is unavailable.



WARNING: *By deselecting this option, technically savvy end users may be able to bypass filtering permanently by disrupting communications between the workstation and the mobile filter host server.*

Optional: Specify URL for Mobile Client Updates



NOTES: A URL directory entry is required in the Automatic Update Settings frame only if the Mobile Client Updater will be installed on end user workstations and a Web server will be used for deploying updated Mobile Client package configuration updates to these workstations.

You do not need to specify a URL directory entry if you wish to use the Web Filter (running software version 4.0 or higher) to deploy updates to end user workstations. However, please note that using the Web Filter to deploy updates could impact the performance of the server.

For more information about using a host server for the Mobile Client Updater, see *MCU file preparations: Choose a deployment host for updates*.

1. In the Automatic Update Settings frame, click the ellipses (...) button to the right of the **Update URL Base** field to open the Add/Remove Update URL(s) dialog box:

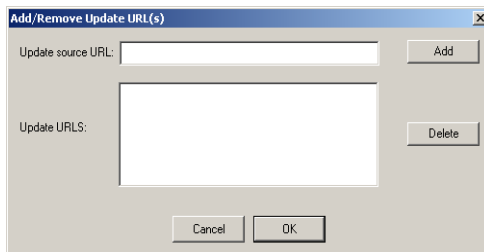

Fig. D-18 Add/Remove Update URL(s)

2. In the **Update source URL** field, enter the URL of the directory to be used for deploying Mobile Client package configuration updates to mobile workstations with the Mobile Client installed. The URL format should include the protocol (e.g. “http”), the port number (if a port other than port 80 is used), the host name, and directory name. For example: **http://www.mycompany.com/mobile_client_updates**



NOTE: Only the HTTP protocol is supported at this time.

3. Click **Add** to include the entry in the list box below.
4. After entering the URL, click **OK** to close the dialog box and to display your entries in the Update URL Base field of the Package Configuration window.



NOTE: To remove a URL from the list, select the entry from the Update URLs list box, click **Delete**, and then click **OK**.

Optional: Set up Application Options



NOTE: Entries in the Application Options Settings frame are only required if you need to modify the behavior of the Mobile Client in order to accommodate specific applications on your network.

Both Windows and Macintosh OS X share a single set of Applications Options Settings. This is not a problem as long as you qualify the application(s) sufficiently to avoid any chance of ambiguity (e.g. “wget” is too short of a qualifier if you want to block it on Macintosh OS X but allow it on Windows).

Types of scenarios in which entries would be made in the Applications Options Settings frame for the Mobile Client include the following:

- Your organization uses a custom application which should never be filtered
- There are specific applications you would like to permanently and unconditionally block from accessing the Internet
- You wish to enable special log-verbosity settings for one or more applications—i.e. to troubleshoot possible conflicts between the Mobile Client and other network applications.

Step 1: First line entry

By default, the Application Options Settings field is empty. If you wish to add any options, you must first type in **Mode 0** on the first line. For example:

```
Mode 0  
{option #1}  
{option #2}  
...
```

Step 2: Identify the name and path of the application

Determine the name and path of the executable program for which network access should be blocked or granted unrestricted network access. For example: Program Files\Mozilla Firefox\Firefox.exe

Step 3: Add an option line for the application

Enter an option line for each application to be blocked or bypassed.

To block an application, for example:

```
block_firefox -c "c:\Program Files\Mozilla Firefox\Firefox.exe" -k
```

To bypass an application, for example:

```
bypass_myapp -c "c:\Program Files\MyCorporation\MyCustomApp\MyApp.exe" -b
```

To enabling verbose logging for an application, for example:

```
logall_IE -c "c:\Program Files\Internet Explorer\iexplore.exe"
-xt *,0 -xl *,0
```

Here's an example of the entire set of entries to enable verbose logging for all applications, block Firefox for Windows, and grant unfiltered access to Myapp.exe:

```
Mode0
logall -c * -xl *,0 -xt *,0
block_firefox -c *\Program Files\Mozilla Firefox\Firefox.exe* -k
pass_myapp -c *\Program Files\MyCompany\MyApp\Myappl.exe* -b
```



NOTES: The first word of each option is an arbitrary “label”; you can use any name containing characters [a-z],[A-Z],[0-9], or an underscore ('_').

The *-c* option specifies a partial command line match. You could, therefore, just specify “Firefox.exe” instead of listing the entire path. However, doing so could also make it easier for a sophisticated end user to exploit a bypass setting.

Line encryptor/decryptor...

Other types of application qualifying arguments exist in addition to the examples provided in the previous paragraphs of this user guide. It is also possible to encrypt the Application Options Settings if you wish to obfuscate them from your users.

 **NOTE:** Contact M86 Technical Support for advanced information about Applications Options Settings.

To encrypt or decrypt commands to be included in the Application Options Settings frame of the Package Configuration window:

1. From the Mobile Client Deployment Tool window, go to **Tools > Line encryptor/decryptor...** to open the **Line encryptor/decryptor** window:

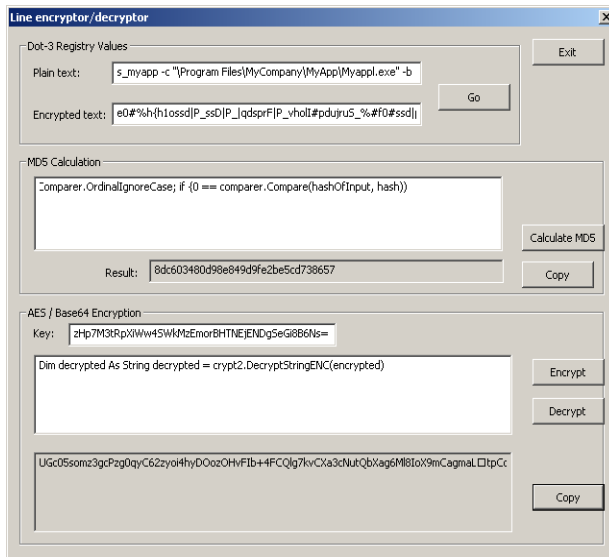

Fig. D-19 Line encryptor/decryptor window

The following frames are included in this window:

- Dot-3 Registry Values - use the tools in this frame to modify .3 registry entries.

- MD5 Calculation - use the tools in this frame to generate an MD5 “digital thumbprint” for a file.
 - AES / Base64 Encryption - use the tools in this frame to generate Advanced Encryption Standard (AES) base64 encryption:
2. Click **Exit** to close this window.

Save configuration settings, download files

In the Package Configuration window, the following options are available from the File menu for saving the package configuration:

- **Save** - Saves the current package
- **Save as...** - Launches the Save Package window in which you specify the **Package Name**, click **OK** and then **Yes** in a dialog box to close both the box and window
- **Save and Quit** - Saves your edits and closes the Package Configuration window

When the package is saved the Configuration revision number in the Package Configuration window is automatically incremented to the next sequential number, and the Mobile Client Package Contents local Web page launches, providing a summary of package contents with links to various components generated in the package:

Mobile Client
Package Contents

Component Versions:

Product version: 3.0.3
 Windows Client version: 3.0.3.0
 Mac OS X Client version: 3.0.1.0
 Windows MCU version: 1.0.0.9
 Mac OS X MCU version: 1.0.0.7

Packages:

Windows - Direct or Group Policy Setup
 This package installs the Windows Mobile Client directly, e.g. by launching it from the client workstation or by assigning it to the client with Windows Group Policy. This is the "normal" installer for Windows. → [8e6client.msi](#)

This package installs the optional Windows Mobile Client Updater component. When installed, the Mobile Client can automatically update itself from the web or R3000 Mobile Server. → [8e6winmcu.msi](#)

Mac OS X Client Installer - Direct or Remote Desktop Setup
 This package installs the Mac OS X Mobile Client directly, e.g. by launching it from the client workstation or by using Apple Remote Desktop to distribute in bulk. → [8e6clientinstaller.mpkg.tar](#)

This package installs the optional Mac OS X Mobile Client Updater component. When installed, the Mobile Client can automatically update itself from the web or R3000 Mobile Server. → [8e6osxmcu.pkg.tar](#)

Auto-Update File Set
 This archive contains all of the files which should be placed on the update server for auto-update. It includes packages for Mac and Windows workstations, as well as support files required by the auto-update infrastructure.

If you are using the R3000 Mobile Server as your update source, this archive can be directly uploaded to the server using the administrative interface. → [mobile-client_3.0.3.tgz](#)

If you are using your own web server as the update source, these files should be extracted onto the server such that they are accessible on the Internet from the URL you specified in the "Update URL" field of the configuration.

Configuration:

The packages in this folder have been configured as follows:

```

Configuration Revision: 1
R3000 Mobile Server(s):
  Host: 192.168.20.77 Port: 443
R3000 Internal Server(s)
  Host: 192.168.20.77 Port: 81
Proxy server:
  Server:
  Port: 0
  Username:
Options:
  Block all network access if filter is not found: true
        
```

Fig. D-20 Mobile Client Package Contents page

The Mobile Client Package Contents page includes the following information:

- **Component Versions** - The Mobile Client Windows and Macintosh version numbers and MCU version numbers
- **Packages** - Links to downloadable components for:
 - Windows - Direct or Group Policy Setup links for downloading the following components:
 - [8e6client.msi](#) - download the Mobile Client application installer file for installation on Windows end user workstations
 - [8e6winmcu.msi](#) - if using the optional Mobile Client Updater feature, download the MCU installer file for installation on Windows end user workstations
 - Mac OS X Client Installer - Direct or Remote Desktop Setup links for accessing the following components:
 - [8e6clientInstaller.mpkg.tar](#) - download the compressed Mobile Client application installer package file and uncompress for installation on Macintosh end user workstations
 - [8e6osxmcu.pkg.tar](#) - if using the optional Mobile Client Updater feature, download the compressed MCU installer package file and uncompress for installation on Macintosh end user workstations
 - Auto-Update File Set - if using the optional MCU feature on a Web Filter running software version 4.0 or higher, download the [mobile-client_{version}.tgz](#) compressed set of Mobile Client files, uncompress and extract files to the designated update server



NOTE: More information about these tools is provided in subsequent pages in this section of the user guide.

- **Configuration** - Mobile Client and server settings:
 - Configuration Revision number
 - Mobile Server Host IP address(es) and Port number(s)
 - Internal Server Host IP address(es) and Port number(s)
 - Proxy server - Server host name or IP address, Port number, and Username if a proxy server was specified
 - Options - Block all network access if filter is not found: true or false, and Update URL if using the Mobile Client Updater and a Web server was specified
 - AppOptions - Application Options Settings entries, if any were made and saved

When you are finished reviewing the contents of the Mobile Client Package Contents page, click the “X” in the upper right corner to close the page.



NOTE: *If you need to find the Mobile Client Package Contents page after you close it, from the Mobile Client Deployment Tool window, go to **File > Explore Packages...** and then locate “Pack-ages-View.html” inside the directory for the corresponding package.*

Edit a Package Configuration

1. From the Mobile Client Deployment Tool window, select **File > Edit Package...** to open the Select Package window:

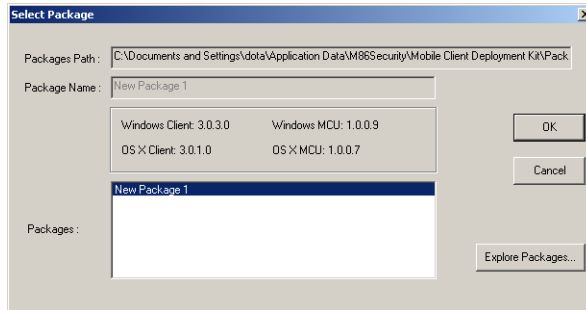



Fig. D-21 Select Package window

2. From the Packages list box, choose the package to be edited; this action populates the Packages Path and Package Name fields with pertinent criteria about the package. The Mobile Client Windows and Macintosh version numbers and MCU version numbers also display.

 **TIP:** Click **Explore Packages...** to open the Mobile Client Deployment Kit's Packages folder and choose the package to be edited from the available selections.

3. Click **OK** to close the Select Package window and to launch the Package Configuration window displaying the last saved edits made for the package.

 **NOTE:** The "Configuration revision" is incremented to the next sequential revision number.

4. After making your edits, choose a Save option for saving the configuration package.

Edit default configuration settings

1. From the Mobile Client Deployment Tool window, select **Tools > Edit default configuration...** to open the Package Configuration window for default settings:

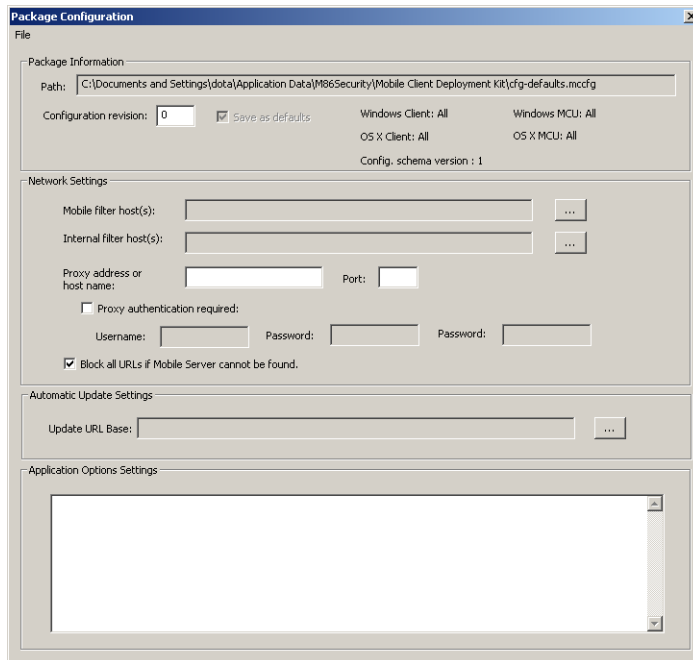

Fig. D-22 Package Configuration window for default settings

This window is similar in appearance to the Package Configuration window used for adding a new package or editing an existing package, except the Package Information frame includes the following differences:

- a different Path is used with the filename “cfg-defaults.mccfg” specified
- “Save as defaults” is greyed-out
- Mobile Client and MCU components for Windows and Macintosh OS X show "All" instead of software version numbers.



TIP: Select **File > Cancel** to exit without saving your edits.

2. Make your edits in this window and then select from the following options to save the default configuration: **File > Save** or **File > Save and Quit**.



NOTE: See *Save configuration settings, download files in Configure a New Package Set* for information about these Save options.

View Package Configuration contents

1. From the Mobile Client Deployment Tool, select **File > Explore Packages...** to open the Packages folder:

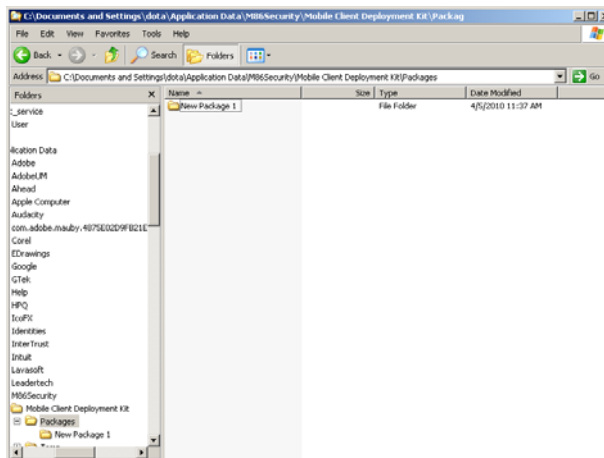

Fig. D-23 Packages folder



TIP: The Packages folder is also accessible from the Select Package window (see Fig. D-21) by clicking the **Explore Packages...** button.

2. Double-click the selected package to display its contents.
3. When you are finished, click the “X” in the upper right corner of the folder to close it.

MCU file preparations

In order to use the optional Mobile Client Updater (MCU) component to distribute product or configuration updates to end users, you must first install the MCU on end user workstations. Then you must select the host server to deploy updates to end user workstations.

Step 1: Install MCU on end user workstations

1. Access the appropriate MCU installer (8e6winmcu.msi for Windows and 8e6osxmcu.pkg.tar for Macintosh OS X) and copy it to respective user workstations.



TIP: *You might want to copy the installers to a master CD-ROM to simplify the installation process.*

2. Install the installer as you would any other program. No configuration is required for the MCU component.



NOTE: *This is a one time operation; after this procedure the MCU will update itself when a new version is deployed.*

Step 2: Choose a deployment host for updates

Decide where to host Mobile Client update files:

- A Web server you maintain
- Mobile Server Web Filter

Host MC file on your Web server

This choice is advantageous for environments with multiple Mobile Server appliances, since update files need to be copied to only one server instead of each Web Filter appliance.



NOTES: *If you choose to host update packages on your own Web server:*

- *The Web server's URL must be specified in the Package Configuration window. If this URL changes at any point in time, before using the "new" server, you must first update the "old" server with the package containing the "new" URL, so that clients know where to get current updates. Thereafter, any newer packages should be uploaded to the "new" server.*
- *The MIME types map may need to be modified in order to support custom file extensions for .mcxml (text/xml) and .mccfg (text/xml).*

Host MC files on the Mobile Server (Web Filter)

This choice is convenient for hosting Mobile Client updates since this Web Filter is already accessible by the Mobile Client application. However, performance issues may arise when a new version of the Mobile Client is available and is being requested by multiple end user workstations simultaneously.

The MCU checks for Mobile Client updates after each successful synchronization attempt. By default, synchronization attempts occur once per hour (unless you have modified the Mobile Server configuration to specify otherwise). When a new Mobile Client version is detected, the MCU immediately attempts to download it. Because the clients do

not coordinate their synchronization attempts with each other, the timing of download attempts will follow a random statistical distribution. Nevertheless, it is conceivable that if you have 4,000 client workstations, they might all attempt to download the update within the first hour after it is posted, although the starting times of each download will vary.



NOTE: *A full Mobile Client update file size is about 1.5 MB for Windows and 1.4 MB for Macintosh OS X (as of software version 3.0.5).*

Step 3: Post the latest files for MCU

Next you must post the Mobile Client configuration files to the host server. After this initial posting, whenever changes are made to the client configuration, or whenever a new software version of the Mobile Client becomes available, you need to post the updated files to this designated host server.

Post MC configuration files to a Web server

If you are using your own Web server as an update host, extract the .tgz file into the host directory associated with the Update URL Base field entry made in the Package Configuration window for that package.

Post MC configuration files to the Mobile Server

If you are using the Mobile Server (Web Filter) as an update host:

1. With the Web Filter user interface launched, go to **System > Mode > Operation Mode** (see Fig. D1).
2. In the Mobile Client Control frame, at the Mobile Client Software Update field click **Upload** to open the Upload Mobile Client Software Package pop-up window:

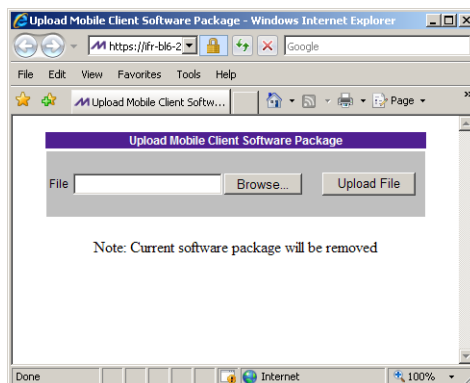

Fig. D-24 Upload Mobile Client Software Package window

3. Click **Browse...** to open the File Upload window and search for the .tgz file to be uploaded to the server.



WARNING: *Uploading subsequent packages of the Mobile Client to the server will overwrite the current file configuration.*

4. Once you have found the file, click **Upload File** to upload the file to the server. After the file has been uploaded a confirmation message displays.
5. Click the “X” in the upper right window of the message window to close it.

How MCU updates clients

The server will unpack the files into the default update location so that clients can find the update as expected. The default location is **http://{mobile_server_address}:81/mobile_client_updates**. To verify that your update files have been posted, go to the file **latest-manifest.mcxml** in this directory. Clients read this file to determine if applicable updates are available.

When the MCU reads available update information, it gives priority to new versions of the software. If a new version of the Mobile Client is available, it is downloaded and installed. Since the updated package contains an embedded copy of the latest configuration, this is adequate to ensure both the software and the configuration are updated. However, if the MCU finds no new software available, it checks to see if a new configuration is available. If the latter is available, that is downloaded and applied. Such updates are much smaller in size than updating an entire new version of the Mobile Client.

MC Deployment to Windows Computers

Deployment to a group

The modified 8e6client.msi file is distributed to multiple Windows workstations by creating a Group Policy Object (GPO) which assigns this software to the required computers on the network.



NOTE: *The procedure suggested below presumes that you are using the free add-on Group Policy Management Console (GPMC) provided by Microsoft.*

1. Make the distribution .msi file available to the target workstations on a network share (e.g. \\{server-name}\8e6MobileClient\8e6client.msi) .
2. Create a new Group Policy Object (GPO):
 - a. in the GPMC, select **Group Policy Management > Forest > Domains > {domain name} > Group Policy Objects**.
 - b. Right-click and choose "New", then create a name for the policy (suggested name: "M86 Mobile Client Deployment"). Click **OK**.
 - c. In the Group Policy Object Editor, open the **{policy name} > Computer Configuration > Software Settings > Software installation node**.
 - d. Click the right panel and choose **New > Package**. Navigate to the distribution .msi file you shared in step 1, and then click "Open". When prompted, select "Assigned" for the deployment method. Click **OK**.
 - e. Right-click the new package and choose **Properties > Deployment**, and then check the "Uninstall this application when it falls out of the scope of management" box. Click **OK**.
 - f. Close the Group Policy Object Editor.

3. Link the new policy:
 - a. In the GPMC, select the domain or organizational unit for which the policy should be applied.
 - b. Right-click, choose "Link an existing GPO", and then select the new policy you created in step 2. Click **OK**.
 - c. Right-click the new policy in the tree, and then de-select the "Link Enabled" menu checkmark. (The link will be re-enabled later in this procedure.)
4. Create a filter for the policy:

A GPO filter limits the scope of the policy so that the Mobile Client is only installed on the appropriate computers. For example, you may want to install it on all workstations but not servers. There are two types of filters: Security filters and WMI filters.

To create a Security filter:

- a. Select the new policy link. Note the "Security Filtering" section in the Scope panel to the right.
- b. Click "Authenticated Users" and then "Remove".
- c. Click "Add...", and then click "Object Types". Check the "Computers" type and uncheck the "Users" type. Click **OK**.
- d. Enter the names of all the computers to receive the Mobile Client installation, separated by semicolons. (Alternatively, you can select a User or Computer group created previously—details of group creation are beyond the scope of this procedure. Click **OK**.

To create a WMI filter:

WMI filters are capable of applying very sophisticated selection criteria to set the scope of a policy. See Microsoft Knowledgebase article #555253 for details on creating WMI filters: <http://support.microsoft.com/kb/555253>

5. Enable the policy link:

Return to the new policy link in the GPMC for the target domain or Organizational Unit, right-click, and then choose "Link Enabled".

6. Test the deployment:

- a. Select one of the workstations within the scope of the policy and refresh its policies by running gpupdate.exe.



NOTE: By default, Windows periodically refreshes the group policy automatically. Using gpupdate allows you to force an immediate refresh for test purposes—this is not something all users on the network should be required to do.

- b. Reboot the workstation and log in.



NOTE: In some cases involving Windows XP workstations, it may be necessary to reboot twice for Group Policy processing to occur.

- c. Verify the Mobile Client is blocking access to unauthorized Web sites, and is allowing access to other sites.

Installation on a single computer

The Mobile Client is manually installed on a single Windows workstation by following these procedures:

1. Go to the folder in which the modified 8e6client.msi file was downloaded, and click the .msi file icon to launch the automatic installation process on the current workstation:

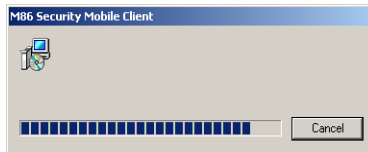

Fig. D-25 Begin Mobile Client installation

After the application has been installed, a dialog box opens asking if you wish to complete the installation process now or later:

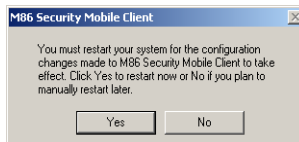

Fig. D-26 Finish installation process

2. To complete the installation process now, save any applications—if necessary, and then click **Yes** to shut down and restart the computer. Or, click **No** to complete the installation process later.

MC Deployment to Macintosh OS X Computers

Apple Computer provides a product called Apple Remote Desktop (<http://www.apple.com/remotedesktop/>) that can be used to deploy Macintosh OS X Mobile Client software version in bulk to many users simultaneously. Contact Apple for additional information about this product.

Mobile Client Removal from Computers

Uninstallation from a Windows group

If the Group Policy that was used for installing the Mobile Client on workstations is removed, the Mobile Client will still remain installed on target workstations. In order to use the Group Policy framework to uninstall the Mobile Client, the Mobile Client Remover (8e6purge.msi) must be deployed using the Group Policy, just as the installer was deployed. Follow the instructions for deploying the Mobile Client, but substitute 8e6purge.msi as the package to be deployed. When the Remover is deployed on the workstation, the Mobile Client will be uninstalled from end users' machines.



NOTE: *The Remover does not require configuration prior to distribution.*

You will probably want to change the name of the policy (e.g. "Remove M86 Mobile Client"). Once the new policy has been processed on all target machines and the Mobile Client has been removed, you can delete or unlink the removal policy with GPMC.

Uninstallation from an individual computer

The Mobile Client can be removed from individual Windows or Macintosh OS X workstations.

To remove the Mobile Client from a Windows computer, follow these procedures:

1. On the Windows workstation that needs to have the Mobile Client removed, go to the taskbar and do the following, based on the type of Windows operating system:
 - Windows Vista / Windows 7: **Start icon > Control Panel > Programs > Programs and Features > {program} > Uninstall**

- Windows XP: **Start > Control Panel > Add or Remove Programs**
2. Find the Mobile Client program and click **Remove** to open the M86 Mobile Client - Uninstall dialog box:

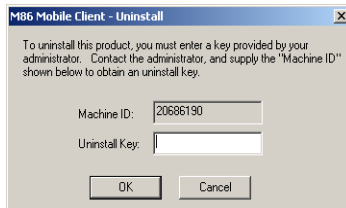

Fig. D-27 Mobile Client Uninstall dialog box

3. Copy the eight-digit number displayed in the **Machine ID** field. In this example: *20686190*
4. Access the Mobile Client Deployment Tool window, and go to **Tools > Create uninstall key...** to open the Create Uninstall Key pop-up window:

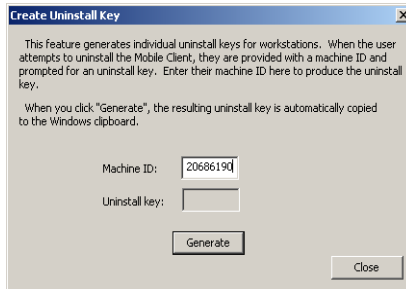

Fig. D-28 Create Uninstall Key pop-up window

In the **Machine ID** field, enter or paste the eight-digit ID number from the Uninstall dialog box. In this example: *20686190*

5. Click **Generate** to display the generated six-character Uninstall key:

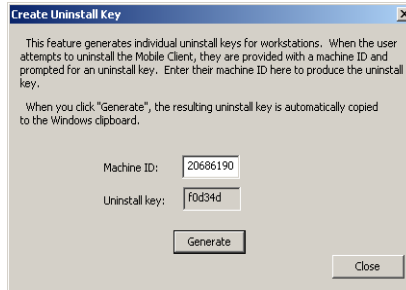

Fig. D-29 Generate a key

Copy this Uninstall key. In this example: *f0d34d*



NOTE: Click **Close** to close the *Create Uninstall Key* pop-up window.

6. Access the M86 Mobile Client - Uninstall dialog box again, and enter the generated password key in the **Key** field. In this example: *f0d34d*

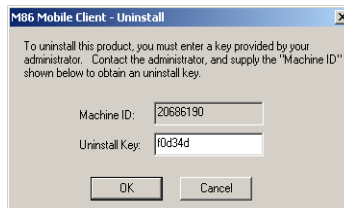

Fig. D-30 Uninstall the Mobile Client

7. Click **OK** to begin the uninstallation process. When the Mobile Client has been uninstalled, a message displays asking you to restart the machine:

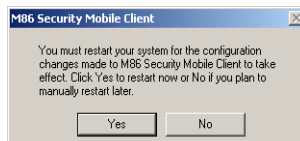

Fig. D-31 Restart message

8. Click **Yes** to restart the machine now, or **No** to restart the machine later.

Appendix E

Configure the Web Filter for Reporting

When configuring the Web Filter to be used with an SR or ER unit, the following procedures must be completed in order for the SR or ER to receive logs from the Web Filter.

Entries in the Web Filter Administrator console

1. Choose Reporting > Report Configuration to display the Report Configuration window.
2. Click the “M86 Security Reporter / M86 Enterprise Reporter” checkbox to display the M86 Security Reporter / M86 Enterprise Reporter tab:

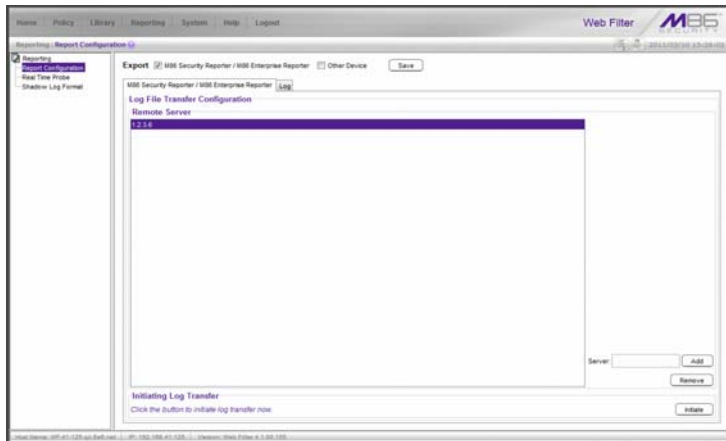

Fig. E-1 Report Configuration window, SR / ER tab

3. In the Log File Transfer Configuration frame, enter the LAN 1 IP address assigned to the M86 SR or ER **Server**, and then click **Add** to include this IP address in the Remote Server list box.



NOTE: To remove an IP address from the list box, select it and click Remove.

- After the SR / ER has been configured, and logs have been transferred from the Web Filter to the SR / ER, click the Log tab to view transfer activity.
- On the Log tab, click **View Log** to view up to the last 300 lines of transfer activity in the View Log frame.



NOTE: It is recommended you wait one to two hours after the initial configuration so sufficient data is available for viewing.

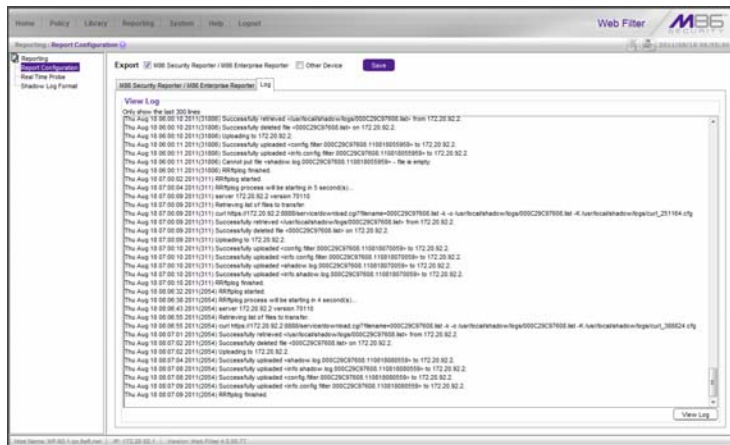

Fig. E-2 Report Configuration window, Log tab

Entries in the SR, ER Administrator console

To see if log files have transferred:

1. Access the SR / ER's Administrator console.
2. From the Database pull-down menu, choose Tools to display the Tools screen.
3. From the Database Status menu, choose File Watch Log.
4. Click **View** to open the File Watch Status pop-up box. If logs are being transferred, you will see an entry that includes the date, time, and IMPORTING: shadow.log.machine1. Once you see an entry, reporting information will be available one hour after the timestamp of the import listing.



NOTE: *Transfers occur each hour.*

Appendix F

RAID and Hardware Maintenance

This appendix is divided into three parts: Hardware Components, Server Interface, and Troubleshooting—in the event of a failure in one of the drives, power supplies, or fans.



NOTE: *As part of the ongoing maintenance procedure for your RAID server, M86 recommends that you always have a spare drive and spare power supply on hand.*

Contact M86 Technical Support for replacement hard drives and power supplies.

Part 1: Hardware Components

The Web Filter “SL” and “HL” RAID server contains two hard drives, two power supplies, and five sets of dual cooling fans (10 in total).

Part 2: Server Interface

LED indicators in SL and HL units

On an “SL” and “HL” unit, the following LED indicators for software and hardware status monitoring display on the left side of the front panel:

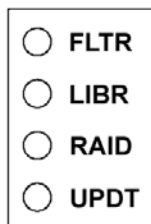

- FLTR = Filtering Status
- LIBR = Library Update Status
- RAID = Hard Drive Status
- UPDT = Software Update Status

LED Indicator Chart

Below is a chart of LED indicators in the “SL” and “HL” unit:

LED Indicator	Color	Condition	Description
FLTR	Green	On	Filtering traffic
	Amber	On	Library being uploaded or one or more processes being started
	Red	On	Not filtering traffic
LIBR	Green	On	Library updated within the past two days or less
	Amber	On	Library updated more than two days ago, but within the past three days
	Red	On	Library updated more than three days ago
RAID	Green	On	RAID mode enabled and running
	--	Off	RAID mode is inactive
	Red	On	Check user interface for status of hard drive
UPDT	Amber	On	Software update detected
	--	Off	No software update detected

Front control panels on SL and HL units

Control panel buttons, icons, and LED indicators display on the right side of the front panel. The buttons let you perform a function on the unit, while an LED indicator corresponding to an icon alerts you to the status of that feature on the unit.

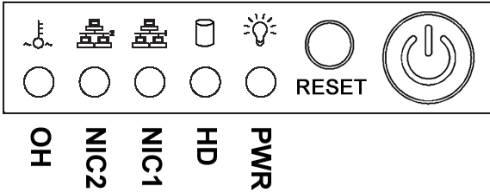

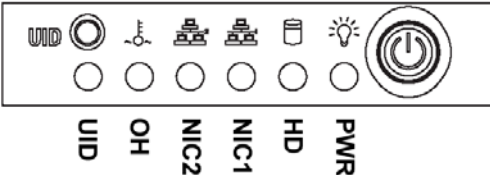

“SL” chassis front panel



“HL” chassis front panel

The buttons and LED indicators for the depicted icons function as follows:

 **UID (button)** – On an “HL” server, when the UID button is pressed, a steady blue LED displays on both the front and rear of the chassis (see also Rear of chassis). These indicators are used for easy location of the chassis in a large stack configuration. The LED remains on until the button is pressed a second time.

 **Overheat/Fan Fail (icon)** – This LED is unlit unless the chassis is overheated. A flashing red LED indicates a fan failure. A steady red LED (on and not flashing) indicates an overheating condition, which may be caused by cables obstructing the airflow in the system or the ambient room temperature being too warm.



NIC2 (icon) – A flashing green LED indicates network activity on LAN2. The LED is a steady green with link connectivity, and unlit if there with no link connectivity.



NIC1 (icon) – A flashing green LED indicates network activity on LAN1. The LED is a steady green with link connectivity, and unlit if there with no link connectivity.



HDD (icon) – In addition to displaying in the control panel, this icon also displays on the front panel on each hard drive carrier. Hard drive activity is indicated by a green LED on an “HL” server, and by an amber LED on an “SL” server. An unlit LED on a drive carrier may indicate a hard drive failure. (See Hard drive failure in the Troubleshooting sub-section for information on detecting a hard drive failure and resolving this problem.)



Power (icon) – The LED is unlit when the server is turned off. A steady green LED indicates power is being supplied to the unit’s power supplies. (See also Rear of chassis.) (See Power supply failure in the Troubleshooting sub-section for information on detecting a power supply failure and resolving this problem.)



Power (button) – When the power button is pressed, the main power to the server is turned on. When the power button is pressed again, the main power to the server is removed but standby power is still supplied to the server.

Rear panels on HL units

UID (LED indicator) – On the rear of the “HL” chassis, to the left of the power supplies, a steady blue UID LED indicator displays when the UID button on the control panel is pressed. This LED remains lit until the UID button is pressed again.

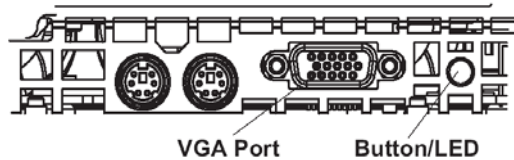

Power Supplies (LED indicators) – The power supplies are located at the right on the rear of the chassis. An LED indicator is located above each of the power plugs. (See Power supply failure in the Troubleshooting sub-section for information on detecting a power supply failure and resolving this problem.)

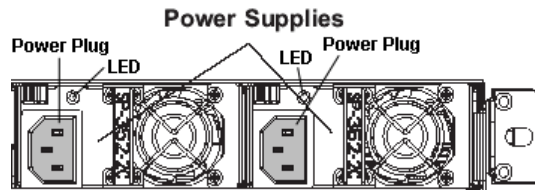

Part 3: Troubleshooting

The text in this section explains how the server alerts the administrator to a failed component, and what to do in the event of a failure.

Hard drive failure

Step 1: Review the notification email

If a hard drive fails, a notification email is sent to the administrator of the server. This email identifies the failed hard drive by its number (HD 1 or HD 2). Upon receiving this alert, the administrator should verify the status of the drives by first going to the Hardware Failure Detection window in the Administrator console.



WARNING: Do not attempt to remove any of the drives from the unit at this time. Verification of the failed drive should first be made in the Administrator console before proceeding, as data on the server will be lost in the event that the wrong drive is removed from the unit.

Step 2: Verify the failed drive in the Admin console

The Hardware Failure Detection window in the Administrator console is accessible via the **System > Hardware Failure Detection** menu selection:



Fig. F-1 Hardware Failure Detection window

The Hardware Failure Detection window displays the current RAID Array Status for the two hard drives (HD 1 and HD 2) at the right side of the window.

Normally, when both hard drives are functioning without failure, the text "OK" displays to the right of the hard drive number, and no other text displays in the window.

However, if a hard drive has failed, the message "FAIL" displays to the right of the hard drive number.

Before taking any action in this window, proceed to Step 3.

Step 3: Replace the failed hard drive

After verifying the failed hard drive in the Administrator console, go to the server to replace the drive.

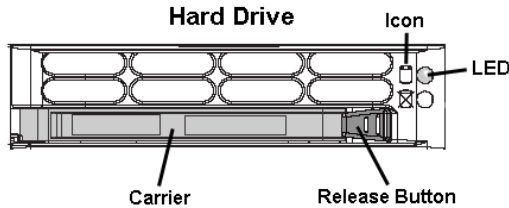

Press the red release button to release the handle on the carrier, and then extend the handle fully and pull the carrier out towards you. Replace the failed drive with your spare replacement drive.

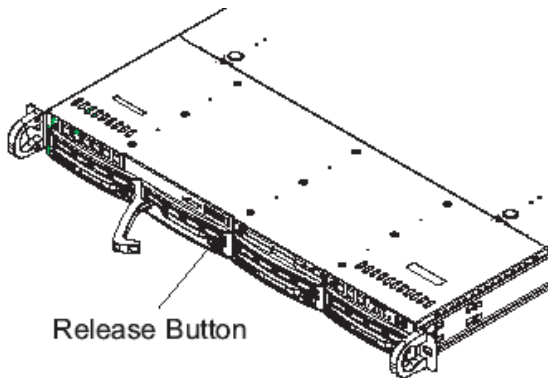

 **NOTE:** Contact Technical Support if you have any questions about replacing a failed hard drive.

Step 4: Rebuild the hard drive

Once the failed hard drive has been replaced, return to the Hardware Failure Detection window in the Administrator console, and click **Rebuild** to proceed with the rebuild process.



WARNING: *When the RAID array reconstruction process begins, the Administrator console will close and the hard drive will become inaccessible.*

Step 5: Contact Technical Support

Contact Technical Support to order a new replacement hard drive and for instructions on returning your failed hard drive to M86.

Power supply failure

Step 1: Identify the failed power supply

The administrator of the server is alerted to a power supply failure on the chassis by an audible alarm and an amber power supply LED—or an unlit LED—on the front and rear of the chassis.



NOTE: *A steady amber power supply LED also may indicate a disconnected or loose power supply cord. Verify that the power supply cord is plugged in completely before removing a power supply.*



WARNING: *Be sure the correct failed power supply has been identified. Removing the wrong power supply will cause the system to crash.*

Step 2: Unplug the power cord

To prevent electrical shock to yourself and damage to the unit, unplug the power cord from the failed power supply.

Step 3: Replace the failed power supply

Remove the failed power supply by locating the red release tab (1) and pushing it to the right (2), then lifting the curved metal handle and pulling the power supply module towards you (3).

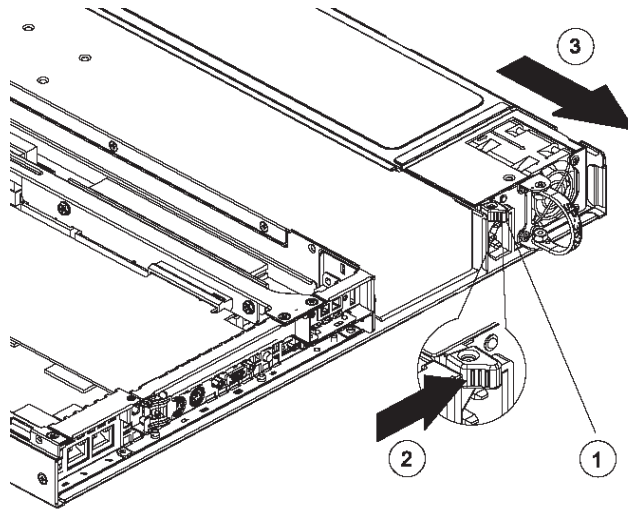

Note that an audible alarm sounds and the LED is unlit when the power supply is disengaged. Replace the failed power supply with your spare replacement power supply. The alarm will turn off and the LED will be a steady green when the replacement power supply is securely locked in place.

Step 4: Contact Technical Support

Contact Technical Support to order a new replacement power supply and for instructions on returning your failed power supply to M86.

Fan failure

Identify a fan failure

A flashing red LED indicates a fan failure. If this displays on your unit, contact Technical Support for an RMA (Return Merchandise Authorization) number and for instructions on returning the unit to M86.

A steady red LED (on and not flashing) indicates an over-heating condition, which may be caused by cables obstructing the airflow in the system or the ambient room temperature being too warm. Check the routing of the cables and make sure all fans are present and operating normally. The LED will remain steady as long as the over-heating condition exists.

Appendix G

Glossary

This glossary includes definitions for terminology used in this user guide.

always allowed - A filter category or port given this designation in a profile will be included in the white list. However, this setting in a library category is overridden if the minimum filtering level is set up to block that category.

Approved Content - A feature that lets users view only the videos posted to YouTube or SchoolTube that are approved for their profile. This feature requires the setup and maintenance of a Web portal, and/or access to VuSafe's portal.

block setting - A setting assigned to a service port or library category when creating a rule, or when setting up a filtering profile or the minimum filtering level. If an item is given a block setting, users will be denied access to it.

custom category - A unique library category that is created by an administrator, and can include URLs, URL keywords, and search engine keywords to be blocked. Group administrators create and manage custom library categories for their own group.

filter setting - A setting made for a service port. A service port with a filter setting uses filter settings created for library categories (block, open, warn, or always allow settings) to determine whether users should be denied or allowed access to that port.

firewall mode - A Web Filter set up in the firewall mode will filter all requests. If the request is appropriate, the original packet will pass unchanged. If the request is inappropriate, the original packet will be blocked from being routed through.

global administrator - An authorized administrator of the network who maintains all aspects of the Web Filter, except for managing master IP groups and their members, and their associated filtering profiles. The global administrator configures the Web Filter, sets up master IP groups, and performs routine maintenance on the server.

group administrator - An authorized administrator of the network who maintains a master IP group, setting up and managing members within that group. This administrator also adds and maintains customized library categories for the group.

individual IP member - An entity of a master IP group with a single IP address.

instant messaging - IM involves direct connections between workstations either locally or across the Internet. Using this feature of the Web Filter, groups and/or individual client machines can be set up to block the use of IM services specified in the library category.

invisible mode - A Web Filter set up in the invisible mode will filter all connections on the Ethernet between client PCs and the Internet, without stopping each IP packet on the same Ethernet segment. The unit will only intercept a session if an inappropriate request was submitted by a client.

keyword - A word or term used for accessing Internet content. A keyword can be part of a URL address or it can be a search term. An example of a URL keyword is the word "essex" in <http://www.essex.com>. An example of a search engine keyword is the entry "essex".

library category - A list of URLs, URL keywords, and search engine keywords set up to be blocked.

LDAP - One of two authentication method protocols used by the Web Filter. Lightweight Directory Access Protocol

(LDAP) is a directory service protocol based on entries (Distinguished Names).

M86 supplied category - A library category that was created by M86, and includes a list of URLs, URL keywords, and search engine keywords to be blocked.

machine name - Pertains to the name of the user's workstation machine (computer).

master IP group - An IP group set up in the tree menu in the Policy section of the console, comprised of sub-groups and/or individual IP filtering profiles.

master list - A list of additional URLs that is uploaded to a custom category's URLs window.

minimum filtering level - A set of library categories and service ports defined at the global level to be blocked or opened. If the minimum filtering level is established, it is applied in conjunction with a user's filtering profile. If a user does not belong to a group, or the user's group does not have a filtering profile, the default (global) filtering profile is used, and the minimum filtering level does not apply to that user. If the minimum filtering level is set up to block a library category, this setting will override an always allowed setting for that category in a user's profile. Minimum filtering level settings can be overridden by profile settings made in override accounts, exception URL settings, and use of the "bypass all" Rule setting.

mobile mode - The operations mode used on a Web Filter configured for filtering end users on machines located outside of the in-house network.

name resolution - A process that occurs when the Web Filter attempts to resolve the IP address of the authentication server with the machine name of that server. This continuous and regulated automated procedure ensures the connection between the two servers is maintained.

net use - A command that is used for connecting a computer to—or disconnecting a computer from—a shared resource, or displaying information about computer connections. The command also controls persistent net connections.

NetBIOS - Network Basic Input Output System is an application programming interface (API) that augments the DOS BIOS by adding special functions to local-area networks (LANs). Almost all LANs for PCs are based on the NetBIOS. NetBIOS relies on a message format called Server Message Block (SMB).

Network Address Translation (NAT) - Allows a single real IP address to be used by multiple PCs or servers. This is accomplished via a creative translation of inside “fake” IP addresses into outside real IP addresses.

open setting - A setting assigned to a service port or library category when creating a rule, or when setting up a filtering profile or the minimum filtering level. If an item is given an open (pass) setting, users will have access to it.

override account - An account created by the global group administrator or the group administrator to give an authorized user the ability to access Internet content blocked at the global level or the group level. An override account will bypass settings made in the minimum filtering level.

peer-to-peer - P2P involves communication between computing devices—desktops, servers, and other smart devices—that are linked directly to each other. Using this feature of the Web Filter, groups and/or individual client machines can be set up to block the use of P2P services specified in the library category.

profile string - The string of characters that define a filtering profile. A profile string can consist of the following components: category codes, service port numbers, and redirect URL.

protocol - A type of format for transmitting data between two devices. LDAP and SMB are types of authentication method protocols.

proxy server - An appliance or software that accesses the Internet for the user's client PC. When a client PC submits a request for a Web page, the proxy server accesses the page from the Internet and sends it to the client. A proxy server may be used for security reasons or in conjunction with caching for bandwidth and performance reasons.

quota - The number of minutes configured for a passed library category in an end user's profile that lets him/her access URLs for a specified time before being blocked from further access to that category

Radius - This feature is used for controlling the filtering levels of dial-up users. The Radius accounting server determines which accounts will be filtered and how they will be filtered. The user profile in the Radius accounting server holds the filter definition for the user.

Real Time Probe - On the Web Filter, this tool is used for monitoring the Internet activity of specified users in real time. The report generated by the probe lets the administrator know whether end users are using the Internet appropriately.

router mode - A Web Filter set up in the router mode will act as an Ethernet router, filtering IP packets as they pass from one card to another. While all original packets from client PCs are allowed to pass, if the Web Filter determines that a request is inappropriate, a block page is returned to the client to replace the actual requested Web page or service.

rule - A filtering component comprised of library categories set up to be blocked, opened, always allowed, or set up with a warning and/or a time quota. Each rule created by the global administrator is assigned a number and a name that should be indicative of its theme. Rules are used when creating filtering profiles for entities on the network.

search engine - A program that searches Web pages for specified keywords and returns a list of the pages or services where the keywords were found.

service port - Service ports can be set up to blocked. Examples of these ports include File Transfer Protocol (FTP), Hyper Text Transfer Protocol (HTTP), Network News Transfer Protocol (NNTP), Secured HTTP Transmission (HTTPS), and Other ports such as Secure Shell (SSH).

SMTP - Simple Mail Transfer Protocol is used for transferring email messages between servers.

SNMP - For the Web Filter, a Simple Network Management Protocol is a third party product used for monitoring and managing the working status of the Web Filter's filtering on a network.

sub-group - An entity of a master IP group with an associated member IP address, and filtering profile.

synchronization - A process by which two or more machines run in parallel to each other. User filtering profiles and library configurations can be set up to be synchronized between multiple Web Filters. The clock on the Web Filter can be set up to be synchronized with a server on the Internet running Network Time Protocol (NTP) software.

time profile - A customized filtering profile set up to be effective at a specified time period for designated users.

Traveler - M86's executable program that downloads updates to your Web Filter on demand or at a scheduled time.

URL - An abbreviation for Uniform Resource Locator, the global address of Web pages and other resources on the Internet. A URL is comprised of two parts. The first part of the address specifies which protocol to use (such as "http"). The second part specifies the IP address or the domain name where the resource is located (such as "203.15.47.23" or "m86security.com").

virtual IP address - The IP address used for communicating with all users who log on the network.

VLAN - Virtual Local Area Network is a network of computers that may be located on different segments of a LAN but communicate as if they were on the same physical LAN segment.

warn setting - A setting assigned to a library category or uncategorized URLs when creating a rule, or when setting up a filtering profile. This designation indicates URLs in the library category or uncategorized URLs may potentially be in opposition to the organization's policies, and are flagged with a warning message that displays for the end user if a URL from that library category or an uncategorized URL is requested.

white list - A list of approved library categories for a specified entity's filtering profile.

INDEX

A

- account
 - password security 98
 - setup 95
- Active connections diagnostic tool 109
- active filtering profiles 23
- Active Profile Lookup window 116
- Additional Language Support window 285
- Admin Audit Trail window 120
- Administrator menu 95
- Administrator window 95
- alert box, terminology 4
- Alert menu 123
- Alert Settings window 123
- always allowed 27
 - definition 518
- Appliance Watchdog 143, 236
- Approved Content 384
 - Real Time Probe 337, 339
- Approved Content portal setup 269, 387
- Approved Content Settings entries 387
- Approved Content Settings window 268, 386, 400, 404
- Approved Content, definition 518
- authentication 160
- Authentication menu 160

B

- backup procedures 162
- Backup/Restore menu 161
- Backup/Restore window 161
- Beta 128
- block page 13, 15, 22, 23, 82, 93, 153
 - custom 431
 - route table 93
- Block Page Authentication window 78
- Block Page Customization window 204

- Block Page Device 153
- Block Page Route Table window 93
- block setting 27
 - definition 518
- button, terminology 4

C

- calculator 66
- category
 - codes 429
 - custom categories 408
 - custom category 25
 - library 25
 - M86 supplied category 308
- category codes 429
- Category Groups menu 307
- category profile
 - global 250
 - IP group 360
 - minimum filtering level 272
- Category Weight System menu 300
- Category Weight System window 300
- Centralized Management Console 37, 140
- checkbox, terminology 4
- CMC Management 140, 144
- CMC Management menu 220
- Common Customization window 198
- Configuration window 281
- contact e-mail addresses 123
- Control menu 72
- CPU Usage diagnostic tool 110
- Ctrl key 65
- Current memory usage diagnostic tool 110
- custom categories 25, 408, 411
 - delete 426
 - menu 411
- Custom Categories menu 408
- custom category
 - definition 518
- Customer Feedback Module menu 296

Customer Feedback Module window 296
Customization menu 197

D

Diagnostics menu 106
dialog box, terminology 4
Disk Usage diagnostic tool 111
DMZ 462

E

Emergency Update Log window 291
Enterprise Reporter 324, 504
environment requirements 10
 Mobile Client 459
EULA 222
Exception URL 383
exception URL 81, 275, 430
Exception URL window 368, 399, 403

F

field, terminology 4
filter option codes 430
filter options
 global group 254
filter setting 28
 definition 518
Filter window 72
filtering 429
 category codes 429
 hierarchy diagram 30
 profile components 24
 profile types 20
 rules 28
 search engine keyword 256
 static profiles 22
 URL keyword 257
Firefox 10, 459
firewall mode 16
 definition 518

- diagram with filtering and cache setup 17
- diagram with firewall and cache setup 16
- frame, terminology 5
- FTP
 - CFM 296
 - Change Log FTP Setup 121
 - proxy setting 282
 - report configuration 327

G

- General Availability 128
- global administrator 1, 2
 - add account 95
 - definition 519
- global filtering profile 23
- global group 18
 - category profile 250
 - default redirect URL 253
 - filter options 254
 - menu 235
 - override account 258
 - port profile 252, 274
- Global Group Profile window 249
- Google Chrome 10
- Google Web Accelerator 76
- Google/Bing/Yahoo!/Youtube/Ask/AOL Safe Search Enforcement
 - global group filter option 255
- grid, terminology 5
- group
 - create IP group 277
 - delete profile 394
 - global 18
 - IP 19, 277
 - types of 18
- group administrator 1, 2
 - definition 519
- Group Details window 348
- Group Profile window 360

H

- Hardware Failure Detection window 179
- Help screen 55
- Help Topics 56
- How to
 - configure filtering 72
 - configure the Minimum Filtering Level 271
 - Bypass Options 275
 - configure the Warn Option Setting 195
 - customize pages 197
 - set up a custom category 408
 - set up a Time Profile 374
 - set up an Override Account
 - Global Group 258
 - Group profile 351
 - set up Exception URLs 368
 - set up pattern detection whitelisting 305
 - set up profile options
 - Global Group Profile 254
 - Group or member Profile 365
 - Override Account profile 264, 357
 - Time Profile 382
 - set up Quotas 225
 - set up Real Time Probes 328
 - set up Search Engine Keywords
 - Custom Categories 424
 - M86 Supplied Categories 318
 - set up URL Keywords
 - Custom Categories 421
 - M86 Supplied Categories 314
 - set up URLs in categories
 - Custom Categories 413
 - M86 Supplied Categories 309
 - set up X Strikes Blocking 181
 - use library categories in a profile
 - Global Group Profile 250
 - Group or member profile 360
 - Override Account profile 260, 353
 - Time Profile 380
 - use rules 245
- HTTPS 11, 69

- login 50
- port numbers 428
- proxy environment 158

HTTPS Filtering 75

I

- Individual IP 402
- individual IP member
 - add to group 393
 - definition 519
 - delete 404
 - profile type 22
- Individual IP Profile window 403
- Installation Guide 50
- instant messaging 31, 308
 - definition 519
- Internet Explorer 10, 459
- invisible mode 13
 - definition 519
 - diagram 13
 - diagram with port monitoring 14
- IP group 19, 277, 347
 - category profile 360
 - create 277
 - diagram 19
- IP Profile Management window 389

J

- Java Plug-in 10, 459
- Java Virtual Machine 10, 459
- JavaScript 10, 459

K

- keyword
 - definition 519
 - search engine, custom category 424
 - search engine, M86 supplied category 318
 - update 283
 - URL, custom category 421

URL, M86 supplied category 314

L

LAN Settings window 88

LDAP

definition 519

LED indicators 507

library

full URL update 284

lookup 293, 406

manual updates 283

search engine keywords, custom category 424

search engine keywords, M86 supplied category 318

software update 284

update categories 283

update logs 286

URL keywords, custom category 421

URL keywords, M86 supplied category 314

URLs, custom category 413

URLs, M86 supplied category 309

weekly update 283

library categories 25

category codes list 429

custom 408

definition 519

M86 supplied 307

Library Details window 308, 411

Library Lookup menu 293, 406

Library Lookup window 293, 406

Library screen 54

Library Update Log window 286

Limited Availability 128

list box, terminology 5

Listening Device 153

Local Software Update window 128, 170, 284

lock page 183

Lock Page Customization window 201

lock profile 21

profile type 23

lockout profile 29

- log
 - backup/restore 172
 - emergency software update 291
 - ER 504
 - library update 286
 - out of the R3000 55
 - R3000 log transfer 323
 - realtime traffic, usage 112
 - software updates 135
- log off
 - Administrator GUI 68
- log on
 - Administrator GUI 50
- Logon Management window 102
- logon script path
 - block page authentication 80
- Logon Settings window 98
- lookup library 293, 406

M

- M86 supplied category 25, 308
 - definition 520
- machine name, definition 520
- Macintosh 10, 459
- Manual Update to M86 Supplied Categories 283
- Manual Update window 283
- master IP group 19
 - definition 520
 - filtering profile 22
 - maintenance 348
 - setup 277
- master list 318
 - definition 520
- Member window
 - Individual IP MAC address 467
- Member window, Individual IP 402
- Members window 349, 397
 - mobile mode 464, 465
- Minimum Filtering Categories
 - categories profile 272

- minimum filtering level 26, 271
 - bypass options 275
 - definition 520
- Minimum Filtering Level window 271
 - categories profile 272
 - port profile 274
- Mobile Client 458
 - Deployment Kit 470
- mobile mode 349, 396, 397, 402, 458
 - definition 520
- Mode menu 152

N

- name resolution, definition 520
- NAT 38, 142, 145
 - definition 521
- navigation panel 59
 - terminology 5
- navigation tips 54
- net use
 - definition 521
- NetBIOS
 - definition 521
- Network Address Translation (NAT), definition 521
- Network menu 88
- network requirements 11, 460
- Network Time Protocol (NTP) 90
- NIC Configuration diagnostic tool 109
- NNTP Newsgroup menu 303
- NNTP Newsgroup window 303
- NTP Servers window 90

O

- open setting 27
 - definition 521
- Operation Mode window 152
 - mobile mode 463
- Options page 82
- override account 351

- AdwareSafe popup blocking 450
- block page authentication 79
- definition 521
- global group 258
- Google Toolbar popup blocking 449
- Mozilla Firefox popup blocking 451
- override popup blockers 446
- profile type 23
- Windows XP SP2 popup blocking 453
- Yahoo! Toolbar popup blocking 447

Override Account window 258, 351

P

P2P

- definition 521

password

- expiration 51, 99
- override account 351
- unlock IP address 104
- unlock username 103

Pattern Detection Whitelist menu 305

Pattern Detection Whitelist window 305

peer-to-peer 31

- definition 521

Ping 108

Policy screen 54

pop-up blocking, disable 446

pop-up box/window, terminology 6

port profile

- global 252, 274
- minimum filtering level 274

Print Kernel Ring Buffer diagnostic tool 111

Process list diagnostic tool 108

profile

- global group 249
- group 360
- individual IP member 403
- minimum filtering level 271
- sub-group 398

Profile Control window 212

- profile string
 - definition 521
 - elements 428
- protocol, definition 522
- Proxy Environment Settings window 158
- proxy server 158, 479
 - definition 522
- pull-down menu, terminology 6

Q

- quota
 - definition 522
 - format 430
- Quota Block Page Customization window 214
- Quota Notice Page Customization window 217
- Quota Setting menu 225
- Quota Setting window 225

R

- radio button, terminology 6
- Radius
 - definition 522
- Radius Authentication Settings menu 174
- Radius Authentication Settings window 174
- Radius profile 21
- RAID 179
- Range to Detect Settings window 143
- Range to Detect window 235
- Real Time Probe 522
- Real Time Probe window 328
- realtime traffic logs 112
- re-authentication
 - block page authentication 79
- Reboot window 86
- Recent Logins diagnostic tool 110
- redirect URL
 - global group 253
- refresh the GUI 64
- Regional Setting window 92

- remote filtering components *460*
- Report Configuration window *323*
- Reporting screen *54*
- requirements
 - environment *10*
- Reset menu *173*
- Reset window *173*
- restore
 - download a file *169*
 - perform a restoration *170*
 - settings *161*
- router mode *15*
 - definition *522*
 - diagram *15*
- Routing table diagnostic tool *109*
- rule *26*
 - definition *522*
- Rules window *245*

S

- Safari *10, 459*
- screen, terminology *6*
- search engine
 - definition *523*
- search engine keyword
 - custom category *424*
 - M86 supplied category *318*
- Search Engine Keyword Filter Control
 - global group filter option *256*
- search engine keyword filtering *256*
- Search Engine Keywords window *318*
 - custom category *424*
- Secure Logon menu *98*
- Security Reporter *324, 504*
- self-monitoring process *123*
- service port *26*
 - definition *523*
- Setup window *141*
- Shadow Log Format window *342*
- Shift key *65*

- ShutDown window 85
- SMTP
 - definition 523
- SMTP Server Settings window 126
- SNMP
 - definition 523
- SNMP window 177
- software
 - emergency update logs 291
 - update logs 135
- software update 284
- Software Update Log window 135
- Software Update Management window 220
- Software Update menu 128
- software updates 128
- Source mode 37, 72, 142
- SSL Certificate menu 231
- SSL Certificate window 231
- Stand Alone mode 37, 72, 140
- static filtering profiles 22
- Status window 147
- Status window, CMC Management 223
- Sub Group (IP Group) window 395
 - MAC addresses 466
- Sub Group Profile window 398
- sub-group 346, 395
 - add to master IP group 392
 - copy 401
 - definition 523
 - delete 401
 - paste 394
- sub-topic 60
 - terminology 7
- synchronization 140
 - backup procedures 47
 - definition 523
 - delays 41
 - overview 36
 - server maintenance 47
- Setup window 141
- Status window 147

- sync items 42
- Synchronization menu 140
- synchronization setup 38
- System Command window 106
- System Performance diagnostic tool 110
- system requirements 10
- System screen 54
- System uptime diagnostic tool 111

T

- TAR profile 21
- Target mode 37, 145
- text box, terminology 7
- Threat Analysis Reporter 29
- time profile
 - add 375
 - definition 523
 - delete 385
 - modify 385
 - profile type 23
- Time Profile window 374, 399, 403
- time-based profile 79
- tolerance timer 184, 255, 265, 358, 366
- tooltips 57
- TOP CPU processes diagnostic tool 109
- topic 59
 - terminology 7
- Trace Route 108
- Traveler 307
 - definition 523
- tree 61, 62
 - terminology 8
- Troubleshooting Mode window 114

U

- update
 - add software update to server 128
 - emergency software updates 291
 - library categories 286

- software 135
- Updates menu 281
- Upload/Download IP Profile 389
- Upload/Download IP Profile window
 - MAC addresses 468
- UPS 69
- Upstream Failover Detect 236
- URL Keyword Filter Control
 - global group filter option 257
- URL keyword filtering 257
- URL Keywords window 314
 - custom category 421
 - M86 supplied category 314
- URL, definition 523
- URL, same URL in multiple categories 300
- URLs window 309
 - custom category 413
 - M86 supplied category 309
- usage logs 112

V

- View Log File window 112
- virtual IP address, definition 524
- VLAN 524
- VuSafe 268, 518

W

- Warn Option Setting window 195
- Warn Page Customization window 208
- warn setting 27
 - definition 524
- Web access logging 31
- Web Filter 1
- Web-based authentication
 - block page authentication 79
- white list
 - definition 524
- wildcard 293, 309, 312, 407, 413, 416
- window, terminology 8

Windows 7 *10*
Windows Vista *10*
Windows XP *10*
workstation requirements *10*
 Mobile Client *459*

X

X Strikes Blocking
 global group filter option *255*
X Strikes Blocking window *181*