



**8e6** R3000 | Enterprise Filter

# QUICK START GUIDE



**Model: R3000**

R3000G (5K02-57), R3000S (5K02-53), R3000MSA (5K02-41)

Release 2.0.00 / Updated: 06.18.07

## 8E6 ENTERPRISE FILTER QUICK START GUIDE

© 2007 8e6 Technologies. All rights reserved.

This document may not, in whole or in part, be copied, photocopied, reproduced, translated, or reduced to any electronic medium or machine readable form without prior written consent from 8e6 Technologies.

Every effort has been made to ensure the accuracy of this document. However, 8e6 Technologies makes no warranties with respect to this documentation and disclaims any implied warranties of merchantability and fitness for a particular purpose. 8e6 Technologies shall not be liable for any error or for incidental or consequential damages in connection with the furnishing, performance, or use of this manual or the examples herein. The information in this documentation is subject to change without notice.

The R3000 products have been tested and found to comply with the limits for a Class A digital device, pursuant to part 15 of the FCC Rules. These limits are designed to provide reasonable protection against harmful interference when the equipment is operated in a commercial environment. This equipment generates, uses, and can radiate radio frequency energy and, if not installed and used in accordance with the instruction manual, may cause harmful interference to radio communications. Operation of this equipment in a residential area is likely to cause harmful interference in which case the user will be required to correct the interference at his own expense.

### **Trademarks**

Other product names mentioned in this manual may be trademarks or registered trademarks of their respective companies and are the sole property of their respective manufacturers.

Part# R3000ce-QSG-070618

# CONTENTS

<b>R3000 ENTERPRISE FILTER INTRODUCTION.....</b>	<b>1</b>
About this Document .....	2
Conventions Used in this Document.....	2
<b>SERVICE INFORMATION .....</b>	<b>3</b>
<b>PRELIMINARY SETUP PROCEDURES .....</b>	<b>4</b>
Unpack the Unit from the Carton .....	4
Select a Site for the Server .....	5
Rack Mount the Server.....	6
Check the Power Supply.....	10
General Safety Information.....	11
<b>INSTALL THE SERVER .....</b>	<b>14</b>
Step 1: Setup Procedures.....	14
Step 1A: Wizard Setup Procedures .....	15
Step 1B: Console Setup Procedures .....	23
Step 2: Test the Connection .....	35
Step 3: Test Filtering or Test the Console Connection .....	36
Step 4: Set Library Updates.....	37
<b>CONCLUSION .....</b>	<b>40</b>
<b>SPECIFICATIONS .....</b>	<b>41</b>
R3000G and R3000S 1U Units .....	41
R3000MSA Mini Tower Unit.....	43
Internal Product Specifications.....	44
Front Panel LED Indicators and Buttons .....	45
<b>REGULATORY SPECIFICATIONS AND DISCLAIMERS.....</b>	<b>47</b>
Declaration of the Manufacturer or Importer .....	47



---

# R3000 ENTERPRISE FILTER INTRODUCTION

Thank you for choosing to evaluate the 8e6 Technologies R3000 Enterprise Filter. The R3000 tracks end users' online activity, and can be configured to block specific Web sites or service ports, thereby protecting your organization against lost productivity, network bandwidth issues, and possible legal problems that can result from the misuse of Internet resources. This product also features expansive library categories, instant message and peer-to-peer blocking, user authentication, and intuitive screens and fields for ease of use when configuring and maintaining the server, as well as managing user and group filtering profiles.

## About this Document

This document is divided into the following sections:

- **Introduction** - This section is comprised of an overview of the R3000 product and how to use this document
- **Service Information** - This section provides 8e6 Technologies contact information
- **Preliminary Setup Procedures** - This section includes instructions on how to physically set up the R3000 in your network environment
- **Install the Server** - This section explains how to configure the R3000 for filtering
- **Conclusion** - This section indicates that the quick start steps have been completed
- **Specifications** - This section features hardware specifications for the R3000 models referenced in this document, and descriptions of front panel LED indicators
- **Regulatory Specifications and Disclaimers** - This section cites safety and emissions compliance information for the R3000 models referenced in this document

## Conventions Used in this Document

The following icons are used throughout this document to call attention to important information pertaining to handling, operation, and maintenance of the server; safety and preservation of the equipment, and personal safety:



**NOTE:** *The “note” icon is followed by additional information to be considered.*

---



**WARNING:** *The “warning” icon is followed by information alerting you to a potential situation that may cause damage to property or equipment.*

---



**CAUTION:** *The “caution” icon is followed by information warning you that a situation has the potential to cause bodily harm or death.*

---

## SERVICE INFORMATION

The user should not attempt any maintenance or service on the unit beyond the procedures outlined in this document.

Any initial hardware setup problem that cannot be resolved at your internal organization should be referred to an 8e6 Technologies solutions engineer or technical support representative.

### 8e6 Corporate Headquarters (USA)

Local : 714.282.6111  
Domestic US : 1.888.786.7999  
International : +1.714.282.6111

### 8e6 Taiwan

Taipei Local : 2501-5285  
Domestic Taiwan : 02-2501-5285  
International : 886-2-2501-5285

### Procedures

When calling 8e6 Technologies regarding a problem, please provide the representative the following information:

- Your contact information.
- Serial number or original order number.
- Description of the problem.
- Network environment in which the unit is used.
- State of the unit before the problem occurred.
- Frequency and repeatability of the problem.
- Can the product continue to operate with this problem?
- Can you identify anything that may have caused the problem?

# PRELIMINARY SETUP PROCEDURES

## Unpack the Unit from the Carton

Inspect the packaging container for evidence of mishandling during transit. If the packaging container is damaged, photograph it for reference.

Carefully unpack the unit from the carton and verify that all accessories are included. Save all packing materials in the event that the unit needs to be returned to 8e6 Technologies.

The carton should contain the following items:

- 1 R3000 unit
- 1 AC Power Cord
- 1 Serial Port Cable
- 1 CAT-5E Crossover Cable
- 1 CAT-5E Coupler
- 1 End User License Agreement (EULA)
- 1 envelope containing a CD-ROM with PDFs of the R3000 User Guide and R3000 Authentication User Guide. The latest version of the R3000 User Guide can be obtained from our Web site at [http://www.8e6.com/docs/r3000\\_ug\\_r2.pdf](http://www.8e6.com/docs/r3000_ug_r2.pdf). The latest version of the R3000 Authentication User Guide can be obtained from our Web site at [http://www.8e6.com/docs/r3000\\_auth2\\_ug.pdf](http://www.8e6.com/docs/r3000_auth2_ug.pdf).



**NOTE:** *If you have the R3000G or R3000S, rack mount brackets (2) also are included for installing the unit in a rack.*

---

Inspect the server and accessories for damage. If the contents appear damaged, file a damage claim with the carrier immediately.

---



**WARNING:** *To avoid danger of suffocation, do not leave plastic bags used for packaging the server or any of its components in places where children or infants may play with them.*

---



---

## Select a Site for the Server

The server operates reliably within normal office environmental limits. Select a site that meets the following criteria:

- Clean and relatively free of excess dust.
- Well-ventilated and away from sources of heat, with the ventilating openings on the server kept free of obstructions.
- Away from sources of vibration or physical shock.
- Isolated from strong electromagnetic fields and noise caused by electrical devices such as elevators, copy machines, air conditioners, large fans, large electric motors, radio and TV transmitters, and high-frequency security devices.
- Access space provided so the server power cord can be unplugged from the power supply or the wall outlet—this is the only way to remove the AC power cord from the server.
- Clearance provided for cooling and airflow: Approximately 12 inches (30.5 cm) in the back, 24 inches (61 cm) on each side, and 9 inches (23 cm) in the front.
- Located near a properly earthed, grounded, power outlet.

# Rack Mount the Server

## Rack Setup Precautions

If you have the 1U unit, you may wish to mount the unit in a rack.

 **Warning:**

Before rack mounting the server, the physical environment should be set up to safely accommodate the server. Be sure that:

- The weight of all units in the rack is evenly distributed. Hazardous conditions may be created by an uneven weight distribution.
- The rack will not tip over when the server is mounted, even when the unit is fully extended from the rack.
- For a single rack installation, stabilizers are attached to the rack.
- For multiple rack installations, racks are coupled together.
- The rack is grounded and will maintain a reliable ground at all times.
- A power cord will be long enough to fit into the server when properly mounted in the rack and will be able to supply power to the unit.
- The connection of the server to the power supply will not overload any circuits.
- The server is only connected to a properly rated supply circuit. Reliable earthing (grounding) of rack-mounted equipment should be maintained.
- The air flow through the server's fan or vents is not restricted.
- The maximum operating ambient temperature does not exceed 104°F (40°C).



**NOTE:** Always make sure the rack is stable before extending a component from the rack.



**WARNING:** Extend only one component at a time. Extending two or more components simultaneously may cause the rack to become unstable.

---

## Rack Mount Instructions

### Rack Setup Suggestions

- Determine the placement of each component in the rack before you install the rails.
- Install the heaviest server components on the bottom of the rack first, and then work up.

### Identify the Sections of the Rack Rails

You should have received two rack rail assemblies with the 8e6 server unit. Each of these assemblies consists of two sections: An inner fixed chassis rail that secures to the unit (A), and an outer fixed rack rail that secures directly to the rack itself (B). A sliding rail guide sandwiched between the two should remain attached to the fixed rack rail. The A and B rails must be detached from each other in order to install.

To remove the fixed chassis rail (A), pull it out as far as possible. You should hear a “click” sound as a locking tab emerges from inside the rail assembly and locks the inner rail. Then depress the locking tab to pull the inner rail completely out. Do this for both the left and right side rack rail.

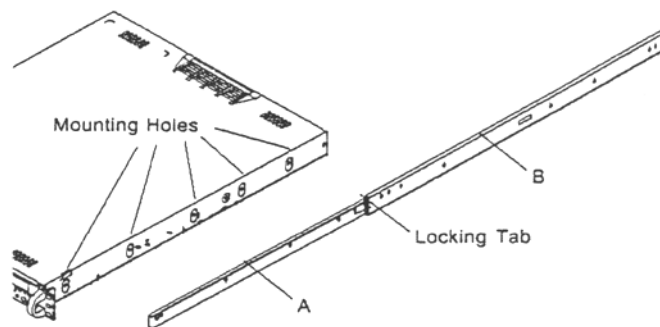

### Install the Chassis Rails

Position the fixed chassis rail sections you just removed along the side of the server chassis making sure the five screw holes line up. Note that these two rails are left/right specific. Screw the rail securely to the side of the chassis. Repeat this procedure for the other rail on the other side of the chassis. You will also need to attach the rail brackets when installing into a Telco rack.

**Locking Tabs:** As you have seen, both chassis rails have a locking tab, which serves two functions. The first is to lock the server into place when installed and pushed fully into the rack, which is its normal position. Secondly, these tabs also lock the server in place when fully extended from the rack. This prevents the server from coming completely out of the rack when you pull it out for servicing.

## Install the Rack Rails

Determine where you want to place the server unit in the rack. Position the fixed rack rail/sliding rail guide assemblies at the desired location in the rack, keeping the sliding rail guide facing the inside of the rack. Screw the assembly securely to the rack using the brackets provided. Attach the other assembly to the other side of the rack, making sure that both are at the exact same height and with the rail guides facing inward.

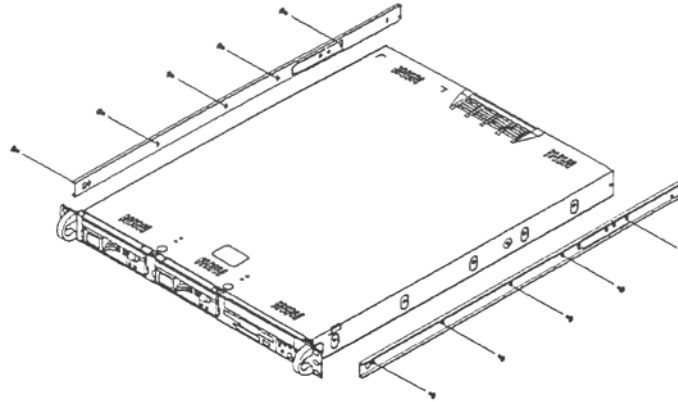

## Install the Server into the Rack

You should now have rails attached to both the chassis and the rack unit. The next step is to install the server chassis into the rack. Do this by lining up the rear of the chassis rails with the front of the rack rails. Slide the chassis rails into the rack rails, keeping the pressure even on both sides (you may have to depress the locking tabs when inserting).

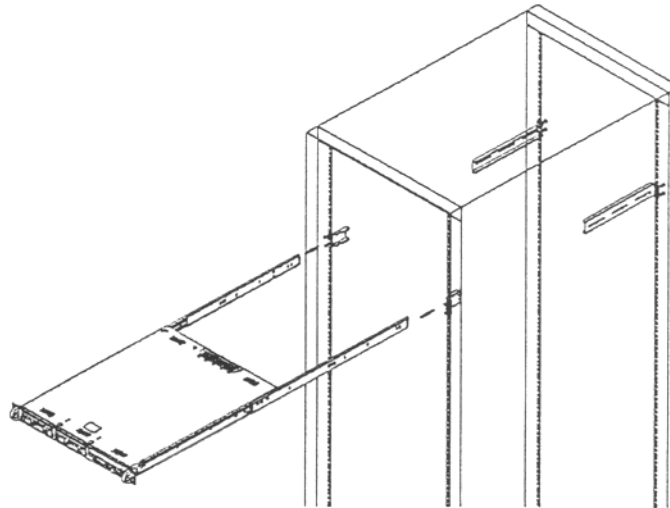

## Installing the Server into a Telco Rack

If you are installing the 8e6 server unit into a Telco type rack, follow the directions given on the previous pages for rack installation. The only difference in the installation procedure will be the positioning of the rack brackets to the rack. They should be spaced apart just enough to accommodate the width of the Telco rack.

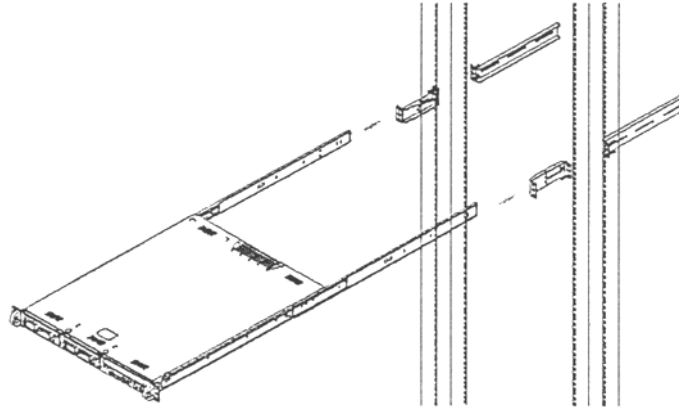

## Check the Power Supply

This server is equipped with a universal power supply that handles 100-240 V, 50/60 Hz. A standard power cord interface (IEC 950) facilitates power plugs that are suitable for most European, North American, and Pacific Rim countries.

### Power Supply Precautions

 **Warning:**

- Use a regulating uninterruptible power supply (UPS) to protect the server from power surges, voltage spikes and to keep the server operating in case of a power failure.
- In geographic regions that are susceptible to electrical storms, 8e6 highly recommends plugging the AC power cord for the server into a surge suppressor.
- Use appropriately rated extension cords or power strips only.
- Allow power supply units to cool before touching them.

# General Safety Information

## Server Operation and Maintenance Precautions

### Warning:

Observe the following safety precautions during server operation and maintenance:

---

 **WARNING:** *If the server is used in a manner not specified by the manufacturer, the protection provided by the server may be impaired.*

---

 **WARNING:** *8e6 Technologies is not responsible for regulatory compliance of any server that has been modified. Altering the server's enclosure in any way other than the installation operations specified in this document may invalidate the server's safety certifications.*

---

 **CAUTION:** *Never pile books, papers, or other objects on the chassis, drop it, or subject it to pressure in any other way. The internal circuits can be damaged, and the battery may be crushed or punctured. Besides irreparable damage to the unit, the result could be dangerous heat and even fire.*

---

 **CAUTION:** *There are no user-serviceable components inside the chassis. The chassis should only be opened by qualified service personnel. Never disassemble, tamper with, or attempt to repair the server. Doing so may cause smoke, fire, electrical shock, serious physical injury, or death.*

---

- Do not insert objects through openings in the chassis. Doing so could result in a short circuit that might cause a fire or an electrical shock.
- Do not operate the server in an explosive atmosphere, in the presence of flammable gases.
- To ensure proper cooling, always operate the server with its covers in place. Do not block any openings on the chassis. Do not place the server near a heater.
- Always exit the software application properly before turning off the server to ensure data integrity.
- Do not expose the server to rain or use near water. If liquids of any kind should leak into the chassis, power down the server, unplug it, and contact 8e6 Technologies technical support.
- Disconnect power from the server before cleaning the unit. Do not use liquid or aerosol cleaners.

## AC Power Cord and Cable Precautions

### Warning:

- The AC power cord for the server must be plugged into a grounded, power outlet.
- Do not modify or use a supplied AC power cord if it is not the exact type required in the region where the server will be installed and used. Replace the cord with the correct type.
- Route the AC power cord and cables away from moving parts and foot traffic.
- Do not allow anything to rest on the AC power cord and cables.
- Never use the server if the AC power cord has been damaged.
- Always unplug the AC power cord before removing the unit for servicing.

## Electrical Safety Precautions

### Warning:

Heed the following safety precautions to protect yourself from harm and the server from damage:

---

 **CAUTION:** *Dangerous voltages associated with the 100-240 V AC power supply are present inside the unit. To avoid injury or electrical shock, do not touch exposed connections or components while the power is on.*

---

- To prevent damage to the server, read the information in this document for selection of the proper input voltage.
- Do not wear rings or wristwatches when troubleshooting electrical circuits.
- To avoid fire hazard, use only the specified fuse(s) with the correct type number, voltage, and current ratings. Only qualified service personnel should replace fuses.
- Qualified service personnel should be properly grounded when servicing the unit.
- Qualified service personnel should perform a safety check after any service is performed.



## Motherboard Battery Precautions



### Caution:

The battery on the motherboard should not be replaced without following instructions provided by the manufacturer. Only qualified service personnel should replace batteries.

The battery contains energy and, as with all batteries, a malfunction can cause heat, smoke, or fire, release toxic materials, or cause burns. Do not disassemble, puncture, drop, crush, bend, deform, submerge or modify the battery. Do not incinerate or expose to heat above 140°F (60°C).

There is a danger of explosion if the battery on the motherboard is installed upside down, which will reverse its polarities.

**CAUTION: DANGER OF EXPLOSION IF BATTERY IS INCORRECTLY REPLACED. REPLACE ONLY WITH THE SAME OR EQUIVALENT TYPE RECOMMENDED BY THE MANUFACTURER. DISPOSE OF THE USED BATTERIES ACCORDING TO THE MANUFACTURER'S INSTRUCTIONS.**

**ATTENTION: IL Y A DANGER D'EXPLOSION S'IL Y A REMPLACEMENT INCORRECT DE LA BATTERIE, REMPLACER UNIQUEMENT AVEC UNE BATTERIE DU MÊME TYPE OU D'UN TYPE ÉQUIVALENT RECOMMANDÉ PAR LE CONSTRUCTEUR. METTRE AU REBUT LES BATTERIES USAGÉES CONFORMÈMENT AUX INSTRUCTIONS DU FABRICANT.**

# INSTALL THE SERVER

## Step 1: Setup Procedures

This step requires you to link the workstation to the R3000. You have the option of using the text-based wizard setup procedures described in Step 1A, or the Administrator console setup procedures described in Step 1B.

### Wizard Setup Requirements

The following hardware can be used for the wizard setup procedures:

- R3000 with AC power cord
- either one of two options:
  - PC monitor with AC power cord and keyboard, or
  - PC laptop computer with HyperTerminal and serial port cable (and USB DB9 serial adapter, if there is no serial port on your laptop)

Go to Step 1A to execute Wizard Setup Procedures.

### Administrator Console Setup Requirements

If your R3000 chassis is a 1U unit, the following hardware is required for the Administrator console setup procedures:

- R3000 1U unit with AC power cord
- CAT-5E crossover cable and coupler
- PC laptop computer, or PC monitor with AC power cord and keyboard

If your R3000 chassis is a mini tower unit, the following hardware is required for the Administrator console setup procedures:

- R3000 mini tower unit with AC power cord
- CAT-5E crossover cable and coupler
- PC laptop computer

Go to Step 1B to execute Console Setup Procedures.

## Step 1A: Wizard Setup Procedures

### Link the Workstation to the R3000

#### Monitor and Keyboard Setup on 1U Units

- Connect the PC monitor and keyboard cables to the rear of the chassis (see Fig. 1).
- Turn on the PC monitor.
- Power on the R3000 by dropping down the face plate and pressing the large button at the right of the front panel (see Fig. 2).

Once the R3000 is powered up, proceed to the Login Screen instructions.

#### Serial Console Setup

- Using the serial port cable (and USB DB9 serial adapter, if necessary), connect the laptop to the rear of the chassis (see Fig. 1 for 1U units and Fig. 3 for mini tower units).
- Power on the laptop.
- Power on the R3000 by pressing the large button on the front panel (see Fig. 2 for 1U units and Fig. 4 for mini tower units).



Fig. 1 - Rear of the 1U chassis

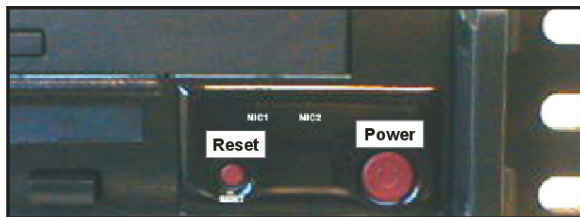

Fig. 2 - Front of the 1U chassis



Fig. 3 - Rear of the mini tower (above).



Fig. 4 - Front of the mini tower (right).

Once the R3000 is powered up, proceed to the instructions for HyperTerminal Setup Procedures.

## HyperTerminal Setup Procedures

If using a serial console, follow these procedures to create a HyperTerminal session on the serial console.

- A. Launch HyperTerminal by going to Start > Programs > Accessories > Communications > HyperTerminal:



- B. In the Connection Description dialog box, enter any session **Name**, and then click **OK** to open the Connect To dialog box:



- C. At the **Connect using** field, select the COM port assigned to the serial port on the laptop (probably “COM1”), and then click **OK** to open the Properties dialog box, displaying the Port Settings tab:

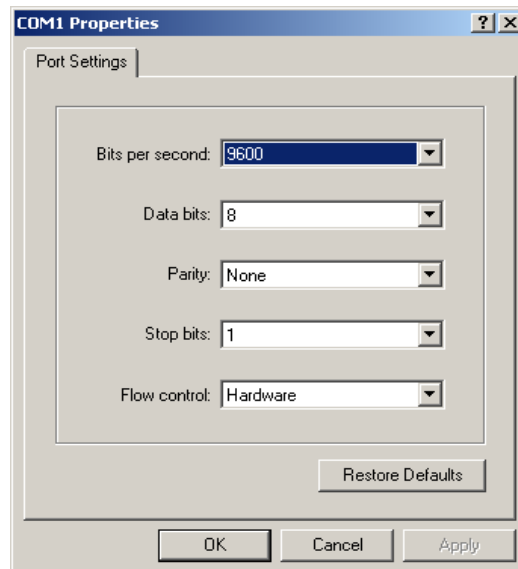

- D. Specify the following session settings:

- Bits per second: 9600
- Data bits: 8
- Parity: None
- Stop bits: 1
- Flow control: Hardware

- E. Click **OK** to connect to the HyperTerminal session:

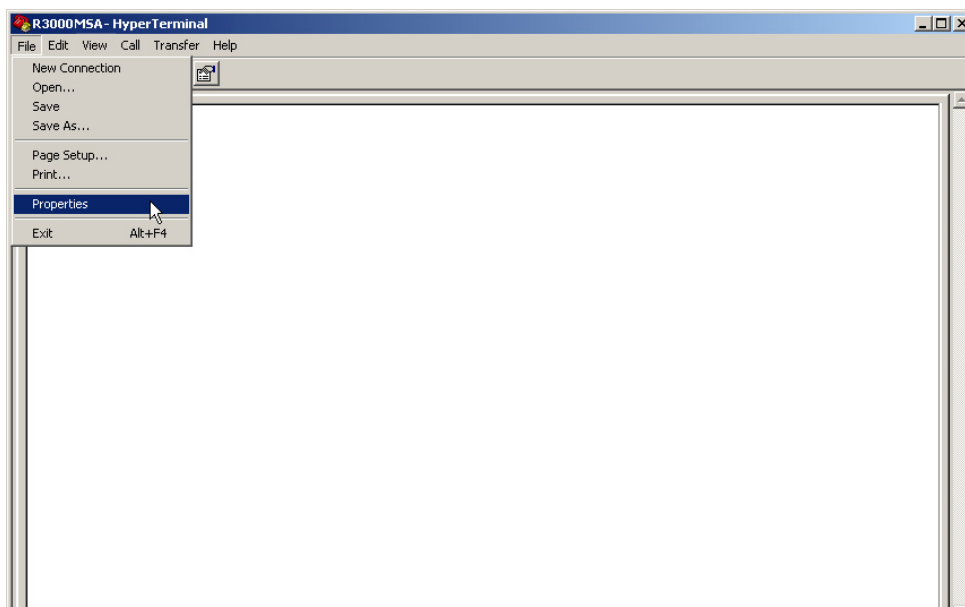

- F. In the HyperTerminal session window, go to File > Properties to open the Properties dialog box, displaying the Connect To and Settings tabs:

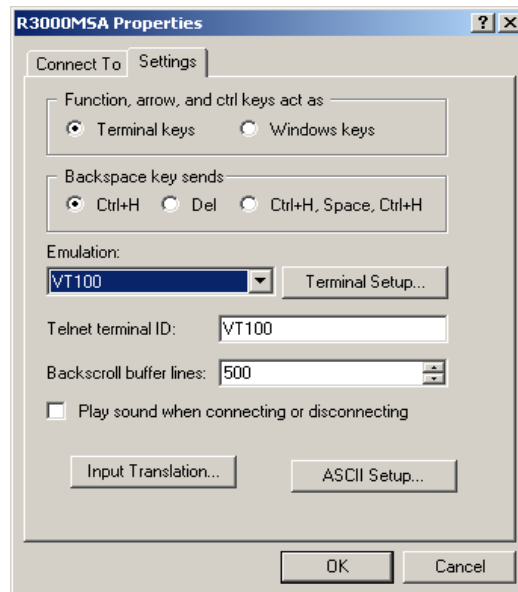

- G. Click the Settings tab, and at the **Emulation** menu select “VT100”.
- H. Click **OK** to close the dialog box, and to go to the login screen.

---

 **NOTE:** If using a HyperTerminal session, the login screen will display with black text on a white background.

---

## Login Screen

The login screen displays after powering on the R3000 1U unit, or creating a HyperTerminal session for the mini tower unit:

```
Red Hat Linux release 9 (Shrike)
Kernel 2.6.19.2-8e6-012307 on an i686

logo.com login:
```

---

 **NOTE:** If the screensaver currently displays on your screen, press the **Enter** key to display the login screen.

---

- A. At the **login** prompt, type in **menu**.
- B. Press the **Enter** key to display the Password prompt.
- C. At the **Password** prompt, type in the following: **#s3tup#r3k**
- D. Press **Enter** to display the System Configuration screen.

## System Configuration Screen

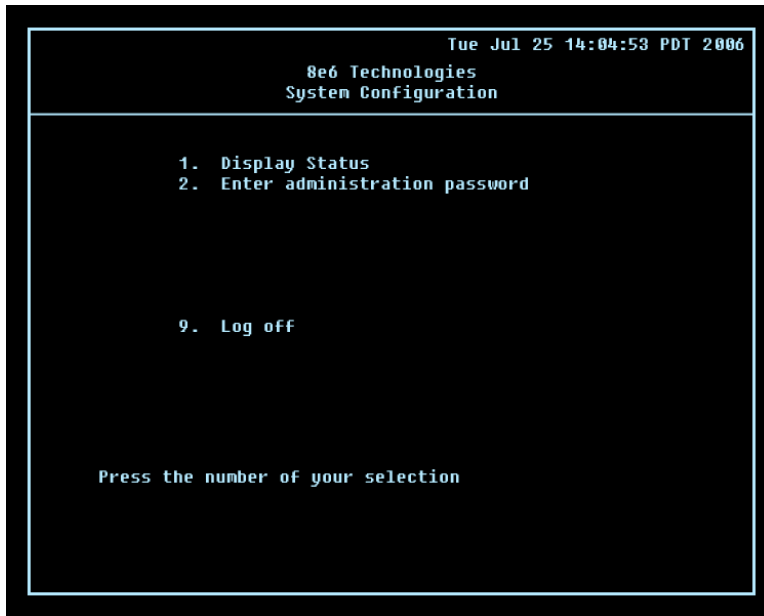

- A. At the **Press the number of your selection** prompt, press **2** to select the setup process for the System Configuration wizard.
- B. At the login prompt, re-enter your password: **#s3tup#r3k**
- C. Press **Enter** to display the Administration menu where you can begin using the System Configuration wizard.



## System Configuration: Administration menu

```

Tue Jul 25 14:05:16 PDT 2006
8e6 Technologies
System Configuration - Administration menu

1. Display Status
2. Initial Setup wizard
3. Change filtering mode
4. Configure network interface LAN1
5. Configure network interface LAN2
6. Configure default gateway
7. Configure DNS servers
8. Configure host name
9. Time Zone regional setting
A. Reset system to factory defaults
B. Reboot system
C. Change administration password

X. Exit administration menu

Press the number of your selection

```

- A. At the **Press the number of your selection** prompt, press **2** to select the “Initial Setup wizard” process.

The wizard takes you to the following system configuration screens to make entries:

- Change filtering mode
- Configure network interface LAN1 (ETH0)
- Configure network interface LAN2 (ETH1)
- Configure default gateway
- Configure DNS servers
- Configure host name
- Time Zone regional setting

---

 **NOTE:** See the Network screens for Operation Mode, LAN Settings, and Regional Setting in Step 1B for content included in the wizard screens.

---

- B. After making all entries using the wizard, press **X** to return to the System Configuration screen. Or, to verify the status of the R3000 and review the entries you made using the wizard, press **1** to view the System Status screen.

---

 **NOTES:** Changing your password using option C, “Change administration password”, will change the password for the console menu but not the R3000 console login screen. Option A, “Reset system to factory defaults”, should only be used by an 8e6 Technologies technical representative.

---

## System Status Screen

```

Tue Jul 25 14:05:16 PDT 2006
8e6 Technologies
System Status - updates every 10 seconds

R3000 is configured in Invisible mode
LAN1 is the Capturing Interface
LAN1 IP = 1.2.3.4 Mask = 255.255.255.255      Inactive
LAN2 is the Management and Blocking Interface
LAN2 IP = 200.10.160.74 Mask = 255.255.0.0   Active
Default gateway IP: 200.10.160.1
R3000 host name: logo.com

DNS server IP address(es): 200.10.160.1
Regional timezone setting: US/Pacific

R3000 processing is initializing
Current Version: R3000 Enterprise Filter 2.0.00.32
Library was last updated on 2007/06/15

Press any key to return to menu...

```

The System Status screen contains the following information:

- **Operation Mode** specified in screen 3 (Change filter mode)
- **Capturing Interface** specified in screen 4 (Configure network interface LAN1/ETH0)
- **LAN1 (eth0) IP** address and netmask specified in screen 4, and current status (“Active” or “Inactive”)
- **Management and Blocking Interface** specified in screen 5 (Configure network interface LAN2/ETH1)
- **LAN2 (eth1) IP** address and netmask specified in screen 5, and current status (“Active” or “Inactive”)
- **Default gateway** IP address specified in screen 6 (Configure default gateway)
- **R3000 host name** specified in screen 8 (Configure host name)
- **DNS server IP address(es)** specified in screen 7 (Configure DNS servers)
- **Regional timezone setting** specified in screen 9 (Time Zone regional setting)
- Current status of the R3000
- Current R3000 software **Version** installed
- Library update status



**NOTE:** Modifications can be made at any time by returning to the specific screen of the wizard.

## Log Off, Disconnect the Peripherals

- After completing the wizard setup procedures, return to the System Configuration screen and press **9** to log out.
- Disconnect the peripherals from the R3000.

## Step 1B: Console Setup Procedures

### Preliminary Setup

Create a “setup workstation” using a Windows-based laptop or desktop machine with a network card and Internet Explorer 5.5 (or later). The setup workstation will be used for accessing the R3000 server on the network and configuring the unit.



**NOTE:** *The Java Plug-in version specified for the R3000 software version must be installed on your workstation. If your workstation does not have Java Runtime Environment, you will be prompted to install it.*

### Workstation Configurations

- A. From the desktop of the setup workstation, follow the procedures for your machine type:
  - **Windows XP** - go to Start > Control Panel. Open Network Connections. Right-click the link for LAN or High-Speed Internet and choose Properties.
  - **Windows 2000** - right-click the My Network Places icon and select Properties. Right-click the correct Local Area Connection and choose Properties.
  - **Windows NT** - right-click the Network Neighborhood icon and select Properties.
  - **Windows ME** - right-click the My Network Places icon and select Properties.
- B. Click on **Internet Protocol (TCP/IP)** to highlight it (Windows NT and ME users should select the Protocols or Configuration tab and choose **TCP/IP Protocol**).
- C. Click the **Properties** button.



**WARNING:** *Be sure to make note of the current network settings on the setup workstation as you will need to return them for further setup procedures.*

- D. Choose the option **Use the following IP address** (Windows NT and ME users should choose the option **Specify an IP Address**).
- E. Type in the **IP address** of 1.2.3.1.
- F. Type in the **Subnet mask** (netmask) of 255.0.0.0 and click **OK**.
- G. Close the LAN connection properties box.

## Link the Workstation to the R3000

The procedures outlined in this sub-section require the use of the CAT-5E crossover cable.

- A. Plug one end of the CAT-5E crossover cable into the R3000's **LAN 2** port.

 **NOTE:** When facing the rear of the 1U chassis, the LAN 2 port is the port on the right.

- B. Plug the other end of the CAT-5E crossover cable into the setup workstation's network card.

 **NOTE:** The CAT-5E coupler can be used if the crossover cable is not long enough for your setup. Plug one end of the CAT-5E crossover cable into the R3000, and the other end into the coupler. Plug a standard CAT-5E cable into the other end of the coupler, and the free end of the standard CAT-5E cable into the setup workstation.

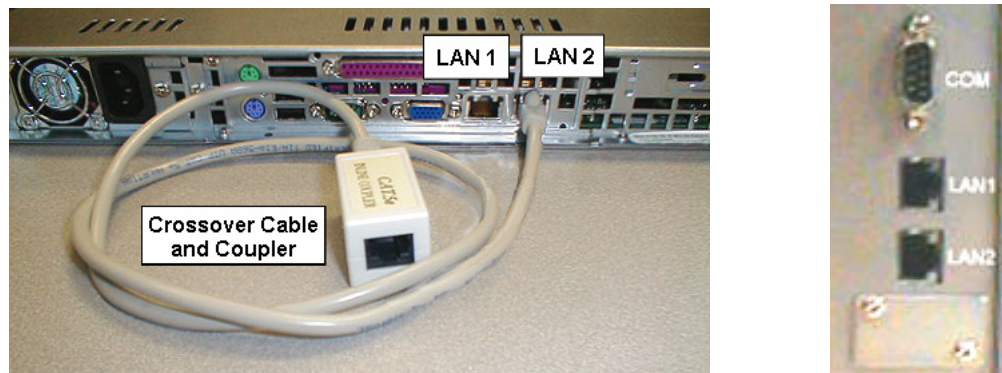

Rear of 1U chassis (left) and mini tower (right)

- C. Plug the R3000 into a power source with an appropriate rating.

 **WARNING:** It is strongly suggested you use an uninterruptible power supply.

- D. Power on the R3000. On a 1U unit, drop down the face plate and press the large button at the right of the front panel (see image below).

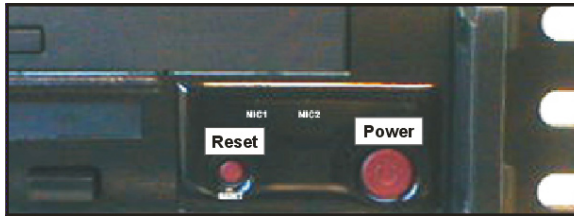

Front of the 1U chassis (left) and mini tower (right)



On a mini tower unit, press the large black button at the top of the front panel (see image to the right).

## The Boot Up Process

The boot-up process may take 5 - 10 minutes. When the drive light remains off for 30 seconds, the system is booted up. (See the Specifications section for a description of Front Panel LED Indicators and Buttons.)

If you wish to verify that the unit has been booted up, you can perform the following test on your workstation:

1. Go to your taskbar and click Start > Run.
2. In the dialog box, type in **cmd** (type in **command** if using Windows ME).
3. Click **OK**.
4. In the cmd.exe window, type in **ping 1.2.3.4**
5. Press **Enter** on your keyboard.

If you receive a reply, the unit is up.

## Network Setup

When the R3000 is fully booted, you can configure network settings. For this step, you will need your network administrator to provide you the host name, gateway address, and two unused IP addresses.

### Access the R3000 Administrator Console

- A. Launch Internet Explorer from the setup workstation.
- B. Type in **http://1.2.3.4:88** in the address field.
- C. Click **Go** to open the R3000 Introductory Window:

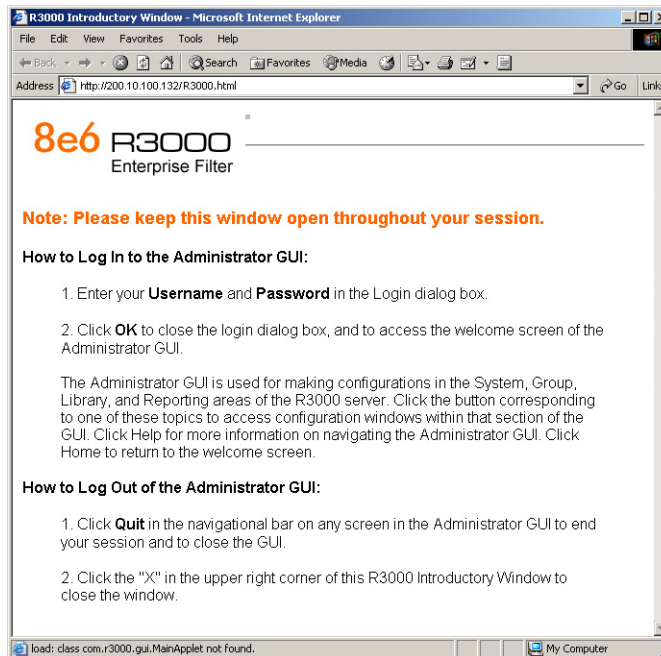

**NOTE:** This window must be left open throughout your session.

The Introductory Window displays minimized when the login dialog box of the R3000 Administrator console application opens (see image on the next page).

## Log in to R3000 Administrator Console

In the login dialog box, you need to enter the generic Username and Password:



- A. In the **Username** field, type in *admin*.
- B. In the **Password** field, type in *user3*.
- C. Click **OK** to close the login dialog box and to go to the main screen of the R3000 Administrator console:



Product	
R3000 Enterprise Filter Version Number	R3000 Enterprise Filter 1.10.00.20
R3000 Enterprise Filter Status	
Last Patch Update	07/10/2006
Last Library Update	07/12/2006

Host Name: logo.com    IP: 200.10.100.75    Version: R3000 Enterprise Filter 1.10.00.24

## Network

Click the **System** button at the top of the screen to go to the System section of the console:



In this section of the console you will:

- Specify the operation mode the R3000 will use for filtering the network, listening to traffic, and sending traffic
- Configure LAN settings the R3000 will use on your network
- Select NTP servers the R3000 will use for time synchronization with Internet clocks
- Indicate the region in which the R3000 is geographically located

 **NOTE:** After saving your entries in each of these windows (Operation Mode, LAN Settings, NTP Servers, Regional Setting), you may be prompted to restart or reboot the server. Click **OK** to acknowledge the contents of the alert box, and then proceed to the next sub-step **without** restarting or rebooting the server.



## Network: Operation Mode

From the navigation panel at the left of the screen, click Mode and choose Operation Mode from the pop-up menu:

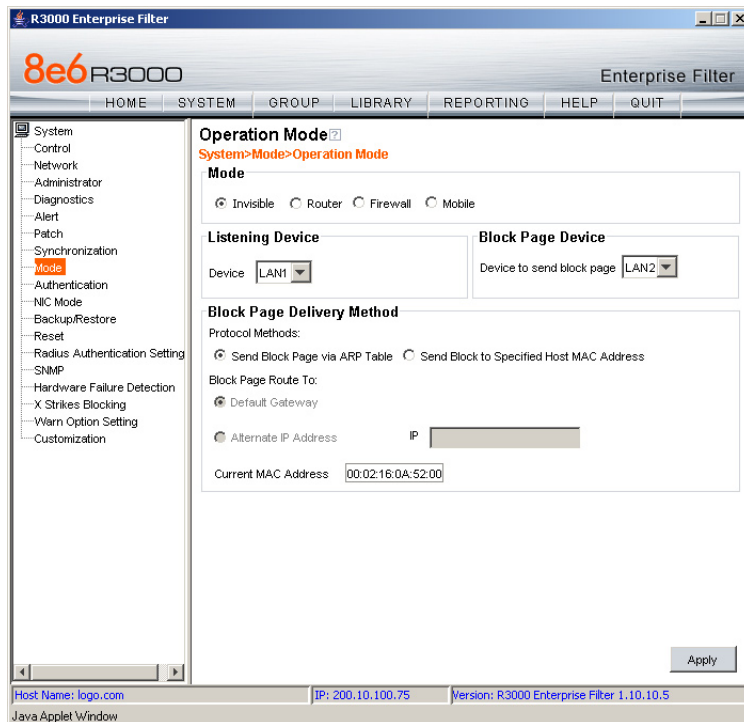

Make the following entries in the Operation Mode window:

- A. In the Mode frame, select the operational mode the R3000 will use for filtering: Invisible, Router, Firewall, or Mobile.



**NOTE:** Refer to the appendix in the R3000 User Guide for information on configuring the R3000 to use the Mobile mode option with the 8e6 Mobile Client.

- B. In the Listening Device frame, select the device for listening to traffic:

- **For the invisible mode:** "LAN1" is generally used as the default listening device
- **For the router or firewall mode:** Select the network card that will be used to "listen to"—as opposed to "send"—traffic on the network

- C. In the Block Page Device frame, select the device for sending block pages to client PCs:

- **For the invisible mode:** The block page device should be a different device than the one selected in the Listening Device frame—"LAN2" is generally used as the default device for sending block pages
- **For the router or firewall mode:** The device should be the same as the one selected in the Listening Device frame

D. Click **Apply**.

## Network: LAN Settings

From the navigation panel, click Network and choose LAN Settings from the pop-up menu:

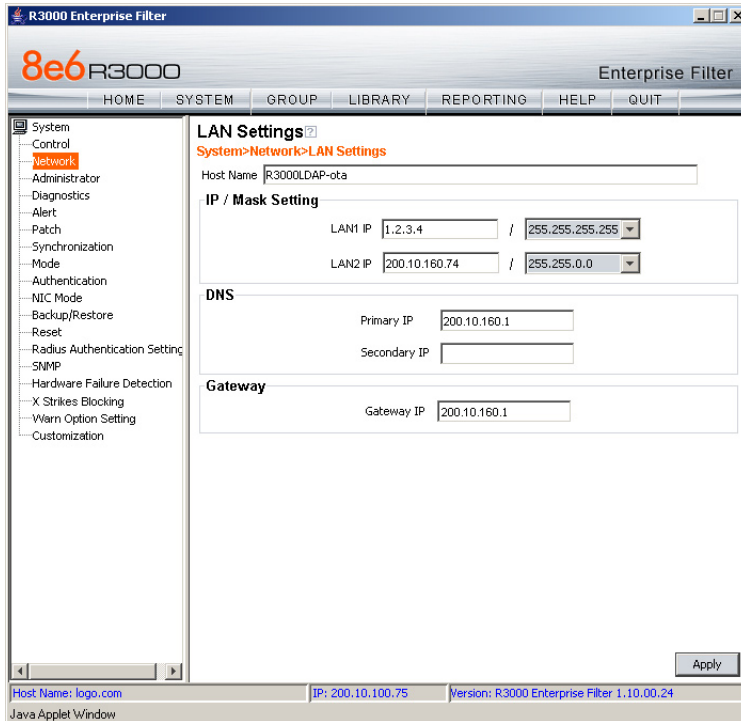

Make the following entries for the R3000 in the LAN Settings window:

- A. Enter the **Host Name** that includes your domain name, for example R3000SERVER.myserver.com (the NetBIOS name must be capitalized). It is important to enter something identifiable, because once the product is registered, this host name is used by 8e6 Technologies to recognize your account for library updates. This name needs to be a valid DNS entry.
- B. Enter the **LAN1 IP** address and specify the subnet for LAN 1, the R3000's first Ethernet Network Interface Card (NIC).  
  
For the invisible mode, you may use a non-routeable IP address for the listening interface and a subnet mask of 255.255.255.255 (32 bites).
- C. Enter the **LAN2 IP** address and subnet for LAN 2, the R3000's second Ethernet NIC. The subnet selection is usually 255.255.0.0 (16 bites) or 255.255.255.0 (24 bites), **but cannot be 255.255.255.255 (32 bites)**.

For the router or firewall mode, the LAN 1 IP address should be in a different subnet than the LAN 2 IP address.

---

 **WARNING:** For the router and firewall mode, do not use the same subnet for LAN 1 and LAN 2 or the console will become inaccessible.

---

- D. Enter the **Primary IP** address of the first DNS name server. The R3000 uses this name server to resolve the domain name requested by users from the LAN.
- E. Enter the **Secondary IP** address of the second DNS name server. The R3000 will use this name server to resolve the domain name requested by users from the LAN if the first DNS isn't working.
- F. Enter the **Gateway IP** address for the default router or firewall that is the main gateway for the entire network. The R3000 will use this IP address to communicate outside the network.

---

 **WARNING:** Be sure to take note of the LAN 1 and LAN 2 IP addresses and host name you assigned to the R3000. It is strongly suggested you document and store this information as it is now the only way of communicating with the R3000.

---

- G. Click **Apply**.

## Network: NTP Servers

From the navigation panel, click Network and choose NTP Servers from the pop-up menu:

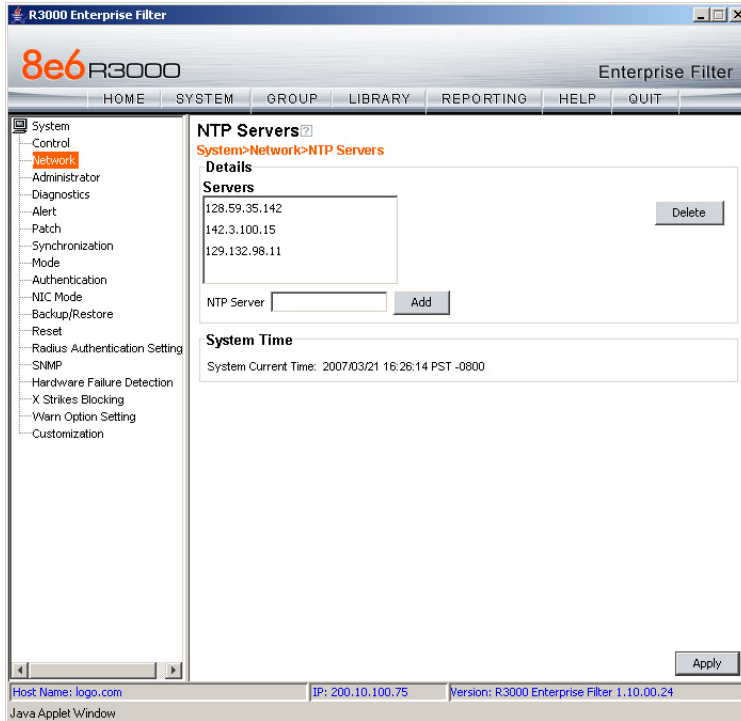

The NTP Servers window is used for specifying the Network Time Protocol (NTP) servers to be used by the R3000, so that the R3000 is synchronized with computer clocks on the Internet.

Note that the following server IP addresses display in the Servers list box: 128.59.35.142, 142.3.100.15, 129.132.98.11. If necessary, any of these servers can be deleted by selecting the IP address and clicking **Delete**.



**NOTE:** If you need to find another NTP server to use, most university Web sites provide these servers for public usage.

- A. In the **NTP Server** field, enter the IP address of the primary NTP server you wish to use for clock settings on your server.
- B. Click **Add** to include this IP address in the Servers list box.
- C. Enter two more NTP servers, following the procedures in sub-steps A and B. These will be the secondary and tertiary NTP servers, in order as they appear in the list box.
- D. Click **Apply**.



**NOTE:** If the primary server fails, the secondary will be used. If the secondary server fails, the tertiary server will be used.

## Network: Regional Setting

From the navigation panel, click Network and choose Regional Setting from the pop-up menu:

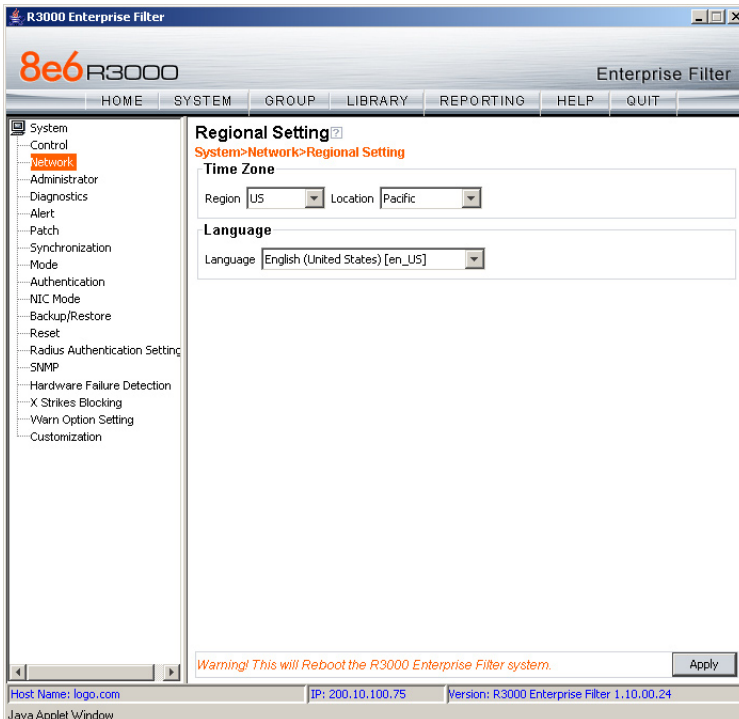

Make the following selections in the Regional Setting window:

- A. At the **Region** pull-down menu, select your country from the available choices.
- B. At the **Location** pull-down menu, select the time zone for the specified region.

If necessary, select a language set from the **Language** pull-down menu to display that text in the console.

- C. Click **Apply** to apply your settings, and to reboot the R3000.

## Physically Connect the R3000 to the Network

Once your R3000 network parameters are set, you must physically connect the unit to your network. This step requires two standard CAT-5E cables.



**NOTE:** *This section requires you to restart the R3000. If you wish to relocate the R3000 before connecting it to the network, you must first shut down the server instead of restarting it. To shut down the R3000, go to the navigation panel, click Control, and then select ShutDown. Once the server is shut down, you must power on the R3000 and then log back into the Administrator console.*

---

- A. Restart the server using the steps defined below (i-iii). These steps must always be performed when restarting the R3000. **Never** reset the server by using the power or reset buttons.
  - i. From the navigation panel of the System section of the console, click Control and select Reboot from the pop-up menu to display the Reboot window.
  - ii. Click the **Reboot** button.
  - iii. From the time you click Reboot, you have approximately 2 minutes to perform sub-steps B through E while the R3000 goes through the reboot process.
- B. Disconnect the crossover cable from the R3000.
- C. Plug one end of a standard CAT-5E cable into the R3000's LAN 1 port.
- D. Plug the other end of the CAT-5E cable into an open port on the network hub that handles the Internet traffic you wish to filter.
- E. Repeat sub-steps B and C for the R3000's LAN 2 port.
- F. Wait until the reboot process has completed, indicated by the drive light staying off for 30 seconds. This process may take 5 to 10 minutes. Proceed to Step 2.



**NOTE:** *If you receive a connection failure message during the reboot process, please disregard it, as this often occurs when there is a change in the IP address.*

---



**NOTE:** *To restart the browser window, close both the R3000 Administrator console and the R3000 Introductory Window. Begin a new session by opening a new browser window and then logging back into the Administrator console.*

---

## Step 2: Test the R3000 Console Connection

Now that the R3000 is physically installed on your network and you have configured its network settings, you need to test the unit to see if it is set up properly.

- A. Restore the setup workstation you used for the Network Setup to its original settings, and connect it to the network hub to create a “network workstation.” (You could also use another workstation already on the network that has Internet access.)
- B. Launch IE on the network workstation, and enter the IP address you assigned to LAN 1 (Step 1A, System Configuration: Administration menu, or Step 1B, Network: LAN Settings, sub-step B). Be sure to include the port information :88 in the address field. For example, if the R3000 were assigned an IP address of 10.10.10.10, you would enter **http://10.10.10.10:88** in the browser window’s address field.
- C. Click **Go**. You should be prompted to log into the Administrator console, giving the Username and Password.

If you can access the R3000 Administrator console, the R3000 is functioning on your network and you should proceed to Step 3.

If you cannot access the R3000 Administrator console, please verify the status of the LAN connection in Windows on the network workstation, and then try enabling/disabling the LAN connection. If that fails to work, check the following:

- The R3000 is turned on.
- The R3000 is connected to the same hub as your router/firewall.
- Can the PC normally connect to the Internet?
- Is the PC able to ping LAN 1 of the R3000?
- Is the R3000 plugged into a switch instead of a hub?
- Is there a caching server?
- Can the R3000 ping the filtered PC? (Refer to the System Command window in the Diagnostics section of the R3000 User Guide)
- Did you restart the R3000 after changing the network settings?
- Do you have both LAN ports connected to your network hub?
- If still unsuccessful, contact an 8e6 Technologies solutions engineer or technical support representative.

## Step 3: Test Filtering or Mobile Client Console Connection

### Test Filtering

If this R3000 has been set up in the Invisible, Router, or Firewall mode, once you have accessed the R3000 Administrator console, you should test filtering.

- A. Test the R3000's filtering by opening a browser window on a network workstation, and going to **http://test.8e6.net** (an empty site for testing pornography filtering).
- B. You should receive a block page. If you do not, contact an 8e6 Technologies solutions engineer or technical support representative.



**NOTE:** Port 22 (SSH) must be open on your network to allow access by remote technical support.

---

### Test the Mobile Client Console Connection

If this R3000 has been set up in the Mobile mode, you do not need to test filtering. Instead, once you have accessed the R3000 Administrator console, you should verify that the Mobile Client can be accessed by the R3000.

- A. Use a workstation on which the Mobile Client is installed that is not on a filtered portion of the LAN. Open a browser window on a network workstation, and then go to **http://test.8e6.net** (an empty site for testing pornography filtering).
- B. The connection should be blocked, and the block page served by the R3000 should display in the browser's Address field. If you do not receive a block page, contact an 8e6 Technologies solutions engineer or technical support representative.



**NOTE:** Port 22 (SSH) must be open on your network to allow access by remote technical support.

---



---

## Step 4: Set Library Updates

After verifying that the R3000 is correctly installed on your network, you need to activate R3000 library updates. Library updates are critical for filtering as new sites are added to the 8e6 library each day. To activate updates, visit the 8e6 Technologies Web site and enter the activation code that was issued to you by e-mail (also included on the product invoice).



**NOTE:** Ports 20 and 21 (FTP) must be open for outgoing requests so that the R3000 can receive library updates.

---

### Activate and Register the R3000

Be sure you have a valid host name chosen before activating your account.

- A. Open an Internet browser window and go to **<http://www.8e6.com/activate>**.
- B. After reading through the online End User License Agreement, click **Accept** to go to Step 2 of the activation process.
- C. Enter your activation code.
- D. Click **Submit** to go to the R3000 Activation and Registration page.
- E. Verify that your serial number and activation code are the same as shown on this registration page.
- F. Fill out the information on this page, including the host name for the public DNS server. ***The entry of the unique host name you've chosen is mandatory in order to receive library updates.***
- G. After all information is entered, click **Activate** to activate your service. You should receive confirmation that the R3000 at your host name has been activated.

You may wish to print the confirmation page for future reference in dealing with technical issues.

## Perform a Complete Library Update

Your R3000 was shipped with the latest library update for the current software release. However, as new updates continually become available, before you begin using the R3000 you must perform a complete library update to ensure you have the latest library updates.

To download the latest library updates, go to the R3000 Administrator console.

- A. Click the **Library** button at the top of the screen.
- B. From the navigation panel, click Updates and select Manual Update from the menu:

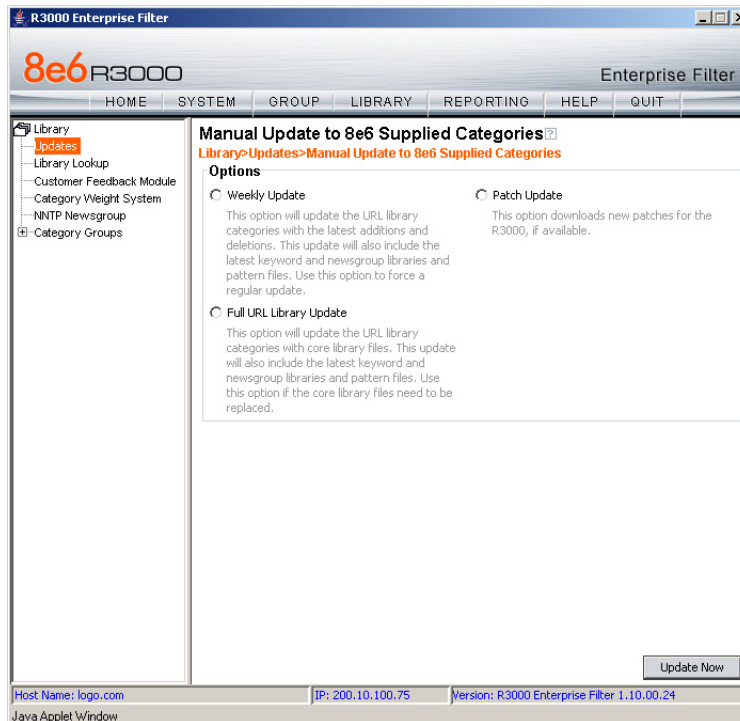



- C. In the Manual Update to 8e6 Supplied Categories window, click the radio button corresponding to **Full URL Library Update**.
- D. Click **Update Now** to begin the update process.

## Monitor the Library Update Process

To verify that the library is being updated:

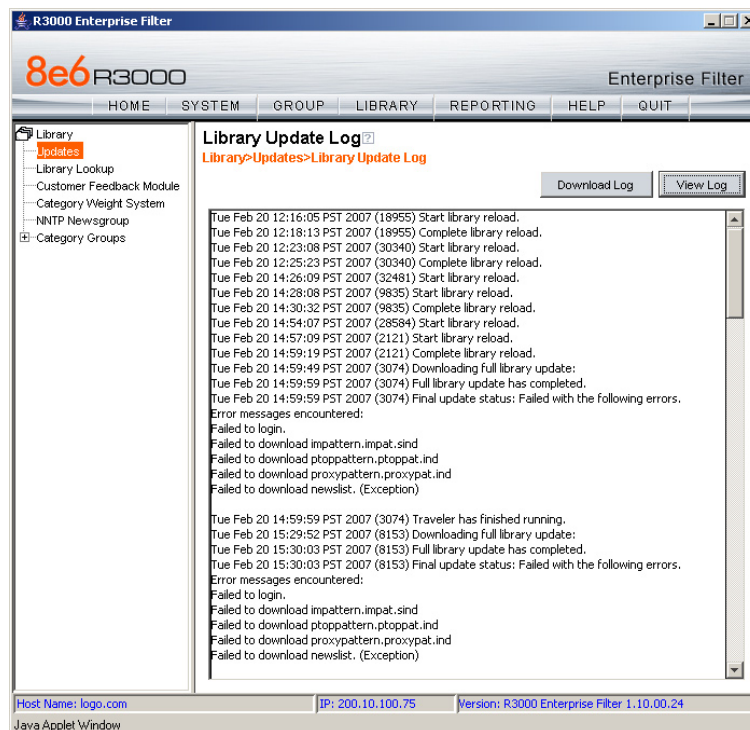
- A. From the navigation panel, click Updates and select Library Update Log from the menu.
- B. In the Library Update Log window, click **View Log** to display the update activity:



 **NOTE:** You will be notified in the log when the library has been completely updated by the message: “Full URL Library Update has completed.” If this message does not yet display, click **View Log** again to view the latest information.

 **WARNING:** At the conclusion of this step, your R3000 will be actively filtering your network. The R3000 is initially set to filter pornography sites on all of your network traffic associated with the hub to which it is connected.

## CONCLUSION

Congratulations; you have completed the R3000 quick start procedures. Now that the R3000 is filtering your network, the next step is to set up groups and create filtering profiles for group members.

To activate a default filter profile more appropriate for your operations, or to specify a more limited IP range to filter, consult Chapter 2: Group screen in the Global Administrator Section of the R3000 User Guide. Refer to Chapter 1: System screen for information on how to give end users access to acceptable HTTPS sites if strict HTTPS filtering settings are used.

Obtain the latest R3000 User Guide at [http://www.8e6.com/docs/r3000\\_ug\\_r2.pdf](http://www.8e6.com/docs/r3000_ug_r2.pdf).

# SPECIFICATIONS

## R3000G and R3000S 1U Units

### 1U Physical Specifications

Specification	Value
Height	1.7" (43mm)
Width	16.8" (426mm)
Depth	22.6" (574mm)
Front clearance	2 inches (76mm)
Side clearance	1 inch (25mm)
Rear clearance	3.6 inches (92mm)
Weight	19.5 lbs (8.85 kg)



## 1U Hardware Component Specifications

Specification	Value
Operating temperature range	10° C ~ 35° C (50° F ~ 95° F)
Storage temperature range	-40° C ~ +60° C (-40° F ~ 158° F)
Operating humidity range	8 ~ 90% non-condensing
Storage humidity range	5 ~ 95% non-condensing
Power supply	260W AC power supply [24-pin, (4-pin = 12V)]
Rated AC input voltage	100 ~ 240V, 50/60Hz, 5-3 Amp
Rated input frequency	50 ~ 60 Hz
Rated input current	5A MAX
Rated output power	260W
Maximum rated BTU	1370 BTUs/Hr
Nominal DC output: +3.3V	15.0A
Nominal DC output: +5V	25.0A
Nominal DC output: +12V	18.0A
Nominal DC output: -12V	1.0A
Nominal DC output: +5V standby	2.0A
Regulatory (power supply)	Power Supply Safety / EMC USA - UL listed, FCC Canada - CUL listed Germany - TUV Certified Europe/CE Mark EN 60950/IEC 60950-Compliant

## R3000MSA Mini Tower Unit

### Mini Tower Physical Specifications

Specification	Value
Height	12.5" (318mm)
Width	4.5" (114mm)
Depth	13.0" (330mm)
Front clearance	2 inches (76mm)
Side clearance	1 inch (25mm)
Rear clearance	3.6 inches (92mm)
Weight	17.0 lbs (7.71 kg)



## Mini Tower Hardware Component Specifications

Specification	Value
Operating temperature range	0 ~ +25° C (0° ~ 77° F)
Storage temperature range	-20° C ~ +80° C (-4° F ~ 176° F)
Operating humidity range	5 ~ 95%
Storage humidity range	5 ~ 95%
Power supply	250W AC power supply
Rated AC input voltage	100 ~ 240V, 50-60Hz, 5-3 Amp
Rated input frequency	50 ~ 60 Hz
Rated input current	5A (RMS) @ 115V AC
Rated output power	250W
Maximum rated BTU	1260 BTUs/Hr
Nominal DC output: +3.3V	18.0A
Nominal DC output: +5V	20.0A
Nominal DC output: +12V	16.0A
Nominal DC output: -12V	0.5A
Nominal DC output: +5V standby	2.0A
Regulatory (power supply)	Approved by UL 60950, CSA C22.2 No. 60950, TUV EN60950, NEMKO (CB Report), CE

## Internal Product Specifications

Specification	R3000G	R3000S	R3000MSA
<b>CPU</b>	2.0GHz P4 CPU	3.6GHz P4 CPU	2.0GHz Celeron CPU
<b>Memory</b>	3GB PC2700 / DDR-333 Dual Channel RAM	3GB PC4200 / DDR2-533 Dual Channel RAM	2GB PC2700 / DDR-333 Dual Channel RAM
<b>Hard drive capacity</b>	1x120GB HDD	1x120GB HDD	1x40GB HDD
<b>Connectivity</b>	10/100/1000 10/100/1000	10/100/1000 10/100/1000	10/100/1000 10/100



## Front Panel LED Indicators and Buttons

### Diagrams and Descriptions

LED indicators and buttons display on the front panel. On the 1U chassis, they are located on the right side (see image below).

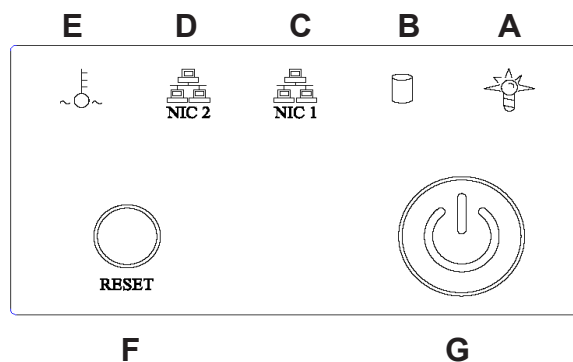

Front panel LED indicators and buttons on the 1U chassis (left) and mini tower (right)

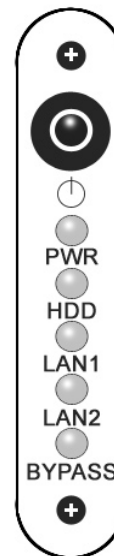

LED indicators alert you to the status of a feature on the unit while buttons let you perform a function on the unit.

### 1U LED Indicators and Buttons

#### LED Indicator Key

- A. Power
- B. HDD Activity
- C. LAN 1
- D. LAN 2
- E. Overheat

#### Button Key

- F. Reset
- G. Power

LED Indicator	Color	Condition	Description
Power	Green	On	System On
		Off	System Off
HDD	Amber	Blinking	HDD Activity
		Off	No HDD Activity
LAN 1 & LAN 2	Green	On	Link Connected
		Blinking	LAN Activity
		Off	Disconnected
Overheat	Red	On	System Overheated
		Off	System Normal

## Mini Tower Indicators

LED Indicator	Color	Condition	Description
Power (PWR)	Green	On	System On
		Off	System Off
HDD	Green	On	HDD Activity
		Off	No HDD Activity
LAN1	Amber	Blinking	LAN Activity
		Off (Normal State)	Disconnected or no LAN Activity
LAN2	Amber	On (Normal State)	Link Connected
		Blinking	LAN Activity
		Off	Disconnected
BYPASS	This feature is not used by this unit		

# REGULATORY SPECIFICATIONS AND DISCLAIMERS

## Declaration of the Manufacturer or Importer

### Safety Compliance

Europe:	Low Voltage Directive (LVD) 73/23/EEC to CB Scheme EN 60950:2001 +A11
International:	TUV/CB to IEC 60950-1:2001 +A11 1st Edition

### Electromagnetic Compatibility (EMC)

USA:	FCC CFR 47 Part 15, Verified Class A Limit
Canada:	IC ICES-003 Class A Limit
China:	China Compulsory Certification (CCC) GB4943-2001, GB9254-1998 (Class A), GB17625.1-2003
Europe:	EMC Directive, 89/336/EEC & Low Voltage Directive (LVD) 73/23/EEC

### Federal Communications Commission (FCC) Class A Notice (USA)

This equipment has been tested and found to comply with the limits for a Class A digital device, pursuant to part 15 of the FCC Rules. These limits are designed to provide reasonable protection against harmful interference when the equipment is operated in a commercial environment. This equipment generates, uses, and can radiate radio frequency energy and, if not installed and used in accordance with the instruction manual, may cause harmful interference to radio communications. Operation of this equipment in a residential area is likely to cause harmful interference in which case the user will be required to correct the interference at his own expense.

### FCC Declaration of Conformity

**Models: 5K02-41, 5K02-53, 5K02-57**

## **Electromagnetic Compatibility Class A Notice**

### **Industry Canada Equipment Standard for Digital Equipment (ICES-003)**

Cet appareil numérique de la classe A respecte toutes les exigences du Règlement sur le matériel brouilleur du Canada.

**English translation of the notice above:**

This Class A digital apparatus meets all requirements of the Canadian Interference-Causing Equipment Regulations.

### **China Compulsory Certification (CCC) - China**

#### **声明**

此为 A 级产品，在生活环境中，该产品可能会造成无线电干扰。在这种情况下，可能需要用户对其干扰采取切实可行的措施。

## EC Declaration of Conformity

### European Community Directives Requirement (CE)

#### Declaration of Conformity

Manufacturer's Name:	8e6 Technologies
Manufacturer's Address:	828 W. Taft Avenue Orange, CA 92865
Application of Council Directive(s):	Low Voltage • 73/23/EEC EMC • 89/336/EEC
Standard(s):	Safety • EN60950: 2001 +A11  EMC • EN55022: 1998 +A2:2003 • EN55024: 1998 +A2:2003 • EN61000-3-2: 2000 • EN61000-3-3: 2001
Product Name(s):	Enterprise Filtering Appliance
Product Model Number(s):	5K02-41, 5K02-53, 5K02-57
Year in which conformity is declared:	2006
I, the undersigned, hereby declare that the equipment specified above conforms to the above Directive(s) and Standard(s).	
Location: Orange, CA, USA	Signature: 
Date: February 22, 2006	Full Name: Gregory P. Smith Position: Director, Product Development

8e6 Corporate Headquarters (USA):  
828 West Taft Avenue Orange, CA 92865-4232 • Tel: 714.282.6111 or 888.786.7999  
Fax: 714.282.6116 (Sales/Technical Support) • 714.282.6117 (General Office)

Satellite Office:  
8e6 Taiwan: RM B2, 13F, No. 49, Sec. 3, Minsheng E. Rd., Taipei 104, Taiwan, R.O.C.  
Tel: 886-2-2501-5285 • Fax: 886-2-2501-5316